

# MPE

## BẢNG GIÁ CATALOGUE

Tháng 03/2022

MPE LED TUBE THỦY TINH GT2

MPE LED TUBE THỦY TINH GT3

MPE LED TUBE THỦY TINH GT5

MPE LED TUBE THỦY TINH GT8



RA  
>80

*Siêu Bền  
Siêu Sáng - Siêu Tiết Kiệm*

*Bảo Hành 5 Năm Đầu Tiên Và Duy Nhất  
Trên Thị Trường*



DIALux  
German Technology

# ĐÈN LED



LED Bulb  
(03 - 15)



LED Panel âm  
(16 - 29)



LED Downlight âm  
(30 - 39)



LED Panel nổi  
(40 - 46)



Cảm Biến Chuyển Động  
(47 - 48)



LED Downlight nổi  
(49 - 52)



LED Ốp Trần  
(53 - 55)



LED Chiếu Điểm  
(56 - 66)



LED Thanh  
(67 - 71)



LED Tấm  
(72 - 76)



LED Tube  
(77 - 82)



LED Bán Nguyệt  
(83 - 84)



LED Chống Thấm  
(85 - 86)



Máng Xương Cá  
(86 - 86)



LED Pha  
(87 - 93)



LED Nhà Xưởng  
(94 - 101)



LED Âm Đất  
(102 - 104)



LED Sân Thể Thao  
(105 - 106)



LED Sân Vườn  
(107 - 110)



LED Chống Nổ  
(111 - 112)



LED Đường Đi  
(113 - 118)



LED Đường Đi NLMT  
(119 - 123)



LED Thoát Hiểm  
(124 - 124)



LED Chiếu Sáng  
Khẩn Cấp  
(125 - 125)



Đèn bàn đa năng  
(126 - 127)



Đèn Pin đa năng  
(127 - 127)

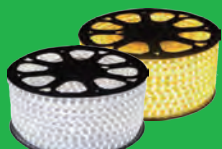

LED Dây  
(128 - 130)



Máng đèn  
(130 - 131)

## THIẾT BỊ ĐIỆN



Công Tắc & Ổ Cắm  
(132 - 146)



Hộp (Box)  
(147- 147)



Ống Luồn  
(148- 154)



Thiết bị đóng cắt, bảo vệ  
MCB, RCCB, RCBO  
(155 - 159)



Cầu dao an toàn SB  
(160 - 160)



Tủ Điện  
(161 - 164)



Ổ Cắm - Phích Cắm  
Công Nghiệp  
(165 - 172)

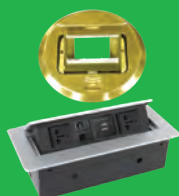

Ổ Cắm Âm Bàn  
Ổ Cắm Âm Sàn  
(173 - 175)



Ổ Cắm Du Lịch  
Ổ Cắm Di Động  
(176 - 177)



Quạt Hút  
(178 - 180)

## THIẾT BỊ THÔNG MINH



MCB, RCBO  
Thông Minh  
(181 - 185)



Ổ Cắm, Ổ Cắm Di Động  
Thông Minh Wifi  
(188 - 189)



Đèn ngủ Wifi  
Đèn bàn Wifi  
(189 - 189)



Công Tắc & Ổ Cắm  
Thông Minh(190 - 191)



Đèn LED Thông Minh  
(Wifi - Zigbee)  
(192 - 199)



Thiết bị cảm biến  
Thông Minh (Wifi - Zigbee)  
(200 - 202)



Thiết bị cảm biến  
Thông Minh(Zigbee)  
(203 - 203)



Hệ Thống An Ninh  
Thông Minh  
(204 - 204)



Cảm Biến  
Chuyển Động  
(205 - 206)



Đèn LED Thông Minh  
(Bluetooth - RF)  
(207 - 213)

## HỆ THỐNG NĂNG LƯỢNG MẶT TRỜI



Hệ Thống Năng Lượng Mặt Trời  
(214 - 228)

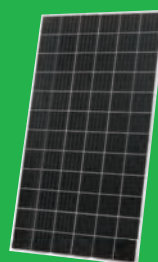

Tấm Pin  
Năng Lượng Mặt Trời  
(229 - 231)



Inverter  
(232 - 233)



**DIALux**  
German Technology



### **ĐẶC ĐIỂM KỸ THUẬT:**

- Tiêu thụ điện năng thấp, tiết kiệm hơn 50% so với đèn dây tóc truyền thống
- Tuổi thọ cao: 30.000 giờ
- Sử dụng chip LED SMD 2835 hiệu suất cao
- Chống va đập, chịu nhiệt và truyền dẫn ánh sáng tốt.
- Có nhiều loại công suất đa dạng
- Driver đèn được sử dụng công nghệ DOB giúp tăng tuổi thọ đèn
- Đui đèn E27, Chất liệu nhôm chống gỉ, dẫn điện tốt
- Thân đèn được làm liền khối. Kiểu dáng và thiết kế sang trọng
- Hệ số hoàn màu cao cho ra ánh sáng trung thực
- Không chứa thủy ngân và hóa chất độc hại

### **ỨNG DỤNG:**

- Chiếu sáng hộ gia đình, văn phòng, nhà hàng, trung tâm thương mại,...

## Seri LBD

	Mã hàng Model	Quang thông Lumens	Nhiệt độ màu CCT	Kích thước Size	Đui đèn Base	Đóng gói Package	Đơn giá (VNĐ)
	<b>LBD-3T</b> <b>LBD-3V</b>	270 Lm	6000 - 6500K 2800 - 3200K	Ø45X82 mm	E27	1 cái/hộp 100 cái/thùng	<b>38.000</b>
	<b>LBD-5T</b> <b>LBD-5V</b>	450 Lm	6000 - 6500K 2800 - 3200K	Ø55X94 mm	E27	1 cái/hộp 100 cái/thùng	<b>46.100</b>
	<b>LBD-7T</b> <b>LBD-7V</b>	700 Lm	6000 - 6500K 2800 - 3200K	Ø60X112 mm	E27	1 cái/hộp 100 cái/thùng	<b>56.700</b>
	<b>LBD-9T</b> <b>LBD-9V</b>	900 Lm	6000 - 6500K 2800 - 3200K	Ø60x118 mm	E27	1 cái/hộp 100 cái/thùng	<b>67.000</b>
	<b>LBD-12T</b> <b>LBD-12V</b>	1200 Lm	6000 - 6500K 2800 - 3200K	Ø67x128 mm	E27	1 cái/hộp 80 cái/thùng	<b>83.600</b>
	<b>LBD-15T</b> <b>LBD-15V</b>	1500 Lm	6000 - 6500K 2800 - 3200K	Ø67x143 mm	E27	1 cái/hộp 80 cái/thùng	<b>110.300</b>

## Seri LBD

	Mã hàng Model	Quang thông Lumens	Nhiệt độ màu CCT	Kích thước Size	Đui đèn Base	Đóng gói Package	Đơn giá (VNĐ)
	<b>LBD-20T</b> <b>LBD-20V</b>	2000 Lm	6000 - 6500K 2800 - 3200K	Ø80X152 mm	E27	1 cái/hộp 20 cái/thùng	<b>129.600</b>
	<b>LBD-30T</b> <b>LBD-30V</b>	3000 Lm	6000 - 6500K 2800 - 3200K	Ø100X180 mm	E27	1 cái/hộp 20 cái/thùng	<b>193.200</b>
	<b>LBD-40T</b> <b>LBD-40V</b>	4000 Lm	6000 - 6500K 2800 - 3200K	Ø118X216 mm	E27	1 cái/hộp 12 cái/thùng	<b>273.300</b>
	<b>LBD-50T</b> <b>LBD-50V</b>	5000 Lm	6000 - 6500K 2800 - 3200K	Ø138X245 mm	E27	1 cái/hộp 8 cái/thùng	<b>389.300</b>
	<b>LBD-60T</b> <b>LBD-60V</b>	6000 Lm	6000 - 6500K 2800 - 3200K	Ø138X272 mm	E27	1 cái/hộp 8 cái/thùng	<b>411.100</b>



Seri LBD2

	Mã hàng Model	Quang thông Lumens	Nhiệt độ màu CCT	Kích thước Size	Đui đèn Base	Đóng gói Package	Đơn giá (VNĐ)
	LBD2-12T LBD2-12V	1200 Lm	6000 - 6500K 2800 - 3200K	Ø65X130 mm	E27	1 cái/hộp 30 cái/thùng	86.000
	LBD2-15T LBD2-15V	1500 Lm	6000 - 6500K 2800 - 3200K	Ø65X130 mm	E27	1 cái/hộp 30 cái/thùng	112.600
	LBD2-20T LBD2-20V	2000 Lm	6000 - 6500K 2800 - 3200K	Ø80X152 mm	E27	1 cái/hộp 20 cái/thùng	129.600
	LBD2-30T LBD2-30V	3000 Lm	6000 - 6500K 2800 - 3200K	Ø100X185 mm	E27	1 cái/hộp 20 cái/thùng	193.200
	LBD2-40T LBD2-40V	4000 Lm	6000 - 6500K 2800 - 3200K	Ø118X216 mm	E27	1 cái/hộp 12 cái/thùng	273.300
	LBD2-50T LBD2-50V	5000 Lm	6000 - 6500K 2800 - 3200K	Ø138X260 mm	E27	1 cái/hộp 8 cái/thùng	389.300



Seri LB	Mã hàng Model	Quang thông Lumens	Nhiệt độ màu CCT	Kích thước Size	Đóng gói Package	Đơn giá (VNĐ)
 <p>12W</p>	<b>LBA-12T</b> <b>LBA-12V</b>	1200 Lm	6000-6500K 2800-3200K	Ø65X125 mm	1 cái/hộp 40 cái/thùng	<b>113.100</b>
 <p>15W</p>	<b>LBA-15T</b> <b>LBA-15V</b>	1500 Lm	6000-6500K 2800-3200K	Ø65X125 mm	1 cái/hộp 40 cái/thùng	<b>128.200</b>
 <p>20W</p>	<b>LB-20T</b> <b>LB-20N</b> <b>LB-20V</b>	2000 Lm	6000 - 6500k 4000 - 4500k 2800 - 3200k	Ø80X150 mm	1 cái/hộp 20 cái/thùng	<b>162.000</b>
 <p>30W</p>	<b>LB-30T</b> <b>LB-30N</b> <b>LB-30V</b>	3000 Lm	6000 - 6500k 4000 - 4500k 2800 - 3200k	Ø100X185 mm	1 cái/hộp 20 cái/thùng	<b>227.500</b>
 <p>40W</p>	<b>LB-40T</b> <b>LB-40N</b> <b>LB-40V</b>	4000 Lm	6000 - 6500k 4000 - 4500k 2800 - 3200k	Ø118X210 mm	1 cái/hộp 12 cái/thùng	<b>345.300</b>
 <p>50W</p>	<b>LB-50T</b>	5000 Lm	6000 - 6500k	Ø135X238 mm	1 cái/hộp 8 cái/thùng	<b>517.200</b>



## Seri LB

	Mã hàng Model	Quang thông Lumens	Nhiệt độ màu CCT	Đui đèn Base	Kích thước Size	Đóng gói Package	Đơn giá (VNĐ)
 <b>60W</b>	LBA-60T	6000 Lm	6000 - 6500k	E40	Ø136X272 mm	1 cái/hộp 8 cái/thùng	<b>895.400</b>
 <b>80W</b>	LBA-80T	8000 Lm	6000 - 6500k	E40	Ø136X272 mm	1 cái/hộp 8 cái/thùng	<b>1.003.200</b>
 <b>60W</b>	LB-60T	5400 Lm	6000 - 6500k	E27	Ø150X280 mm	1 cái/hộp 9 cái/thùng	<b>964.900</b>
 <b>80W</b>	LB-80T	7200 Lm	6000 - 6500k	E27	Ø150X280 mm	1 cái/hộp 9 cái/thùng	<b>1.201.200</b>
 <b>100W</b>	LB-100T	10.000 Lm	6000 - 6500k	E40	Ø150X330 mm	1 cái/hộp 9 cái/thùng	<b>1.790.300</b>

## Chóa Đèn

	Mã hàng Model	Diễn giải	Đơn giá (VNĐ)
	RFL-20	Dùng cho đèn LB-20	<b>83.200</b>
	RFL-30	Dùng cho đèn LB-30	<b>102.900</b>
	RFL-40	Dùng cho đèn LB-40	<b>138.600</b>
	RFL-50	Dùng cho đèn LB-50, LBA-60, LBA-80	<b>166.300</b>
	RFL-SMD	Dùng cho đèn LB-60, LB-80, LB-100	<b>288.800</b>

## Đui Đèn

Mã hàng	Đơn giá (VNĐ)
E27-40	<b>9.200</b>

## Đui Đèn

Mã hàng	Đơn giá (VNĐ)
E40-27	<b>43.900</b>

Kích thước chóa đèn 120°

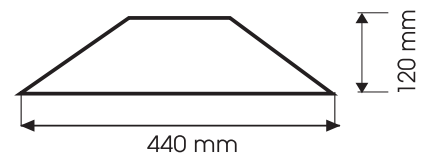

Seri LB	Mã hàng Model	Quang thông Lumens	Nhiệt độ màu CCT	Kích thước Size	Đóng gói Package	Đơn giá (VNĐ)
LED Bulb 3CCT <b>9W</b>	LB-9/3C	850 Lm	6500-3000-4000K	Ø60x108 mm	1 cái/hộp 100 cái/thùng	<b>139.800</b>
LED Bulb 3 mức sáng <b>9W</b>	LB-9T/3DIM	806 Lm	6000-6500K	Ø60x110 mm	1 cái/hộp 50 cái/thùng	<b>95.900</b>
LED Bulb Chống muối <b>9W</b>	LB-9T/AM	806 Lm	6000-6500K	Ø60x120 mm	1 cái/hộp 50 cái/thùng	<b>174.500</b>
<b>New</b> LED Bulb Cảm biến chuyển động Microwave <b>9W</b>	LB-9T/MS	900 Lm	6000-6500K	Ø70x120 mm	1 cái/hộp 100 cái/thùng	<b>291.000</b>
<b>New</b> LED Bulb Chống ẩm <b>9W</b>	LBL2-9T LBL2-9V	1000 Lm	6000-6500K	Ø70x128 mm	1 cái/hộp 80 cái/thùng	<b>67.000</b>
LED Bulb Tích điện <b>10W</b>	LB10T/E	1000 Lm	6000-6500K	Ø68x145 mm	1 cái/hộp 100 cái/thùng	<b>265.700</b>
LED Bulb Tích điện <b>12W</b>	LB12T/E	1200 Lm	6000-6500K	Ø78x158 mm	1 cái/hộp 100 cái/thùng	<b>288.800</b>



**New**





**DIALux**  
German Technology

## LED Bulb Thanh Long

- Tiết kiệm năng lượng, hiệu quả cao khi áp dụng vào trồng trọt trong nông nghiệp.
- Tiết kiệm năng lượng từ 50% so với các loại đèn thông thường.
- Tuổi thọ đèn cao: 30.000 giờ
- Đèn ít phát sinh nhiệt trong chiếu sáng cây trồng nên ít bốc hơi nước giúp giảm thiểu lượng nước cung cấp cho cây.
- Photons: 12.5 $\mu$ mol/s (9W) và 17 $\mu$ mol/s (12W), lượng photons cao giúp cho cây trồng có năng suất quang hợp cao và tốt hơn.
- Đèn bulb thanh long có phổ ánh sáng chuyên dụng, giúp kích thích sự phát triển của hoa và trái thanh long giúp nâng cao năng suất và đem lại hiệu quả cho nhà vườn.
- Đèn có 2 loại công suất: 9W, 12W giúp khách hàng có thể lựa chọn phù hợp với không gian nuôi trồng của mình.
- Đèn dễ dàng lắp đặt, thay thế với đui đèn E27
- Đèn có thể chịu được nắng mưa, tác động của môi trường nên rất an toàn khi sử dụng

LED Bulb Thanh Long	Mã hàng Model	Phontons	Quang thông Lumens	Kích thước Size	Đóng gói Package	Đơn giá (VNĐ)
	LBF-9	12,5 $\mu\text{mol/s}$	140-360 Lm	$\varnothing$ 60 x 112 mm	1 cái/hộp 100 cái/thùng	<b>102.900</b>
	LBF-12	17 $\mu\text{mol/s}$	140-360 Lm	$\varnothing$ 70 x 127 mm	1 cái/hộp 100 cái/thùng	<b>139.800</b>

Đèn LED Gara	Mã hàng Model	Quang thông Lumens	Nhiệt độ màu CCT	Góc chiếu Angle	Đóng gói Package	Đơn giá (VNĐ)
	DFL-60T	7200 Lm	6500K	90° có thể điều chỉnh	1 cái/hộp 12 cái/thùng	<b>1.457.600</b>

LED Bulb Dùng Điện DC12V	Mã hàng Model	Quang thông Lumens	Điện áp Volt	Nhiệt độ màu CCT	Kích thước Size	Đóng gói Package	Đơn giá (VNĐ)
	LB-9T/DC	806 Lm	12VDC	6000 - 6500K	$\varnothing$ 60 x 110 mm	1 cái/hộp 100 cái/thùng	<b>116.600</b>

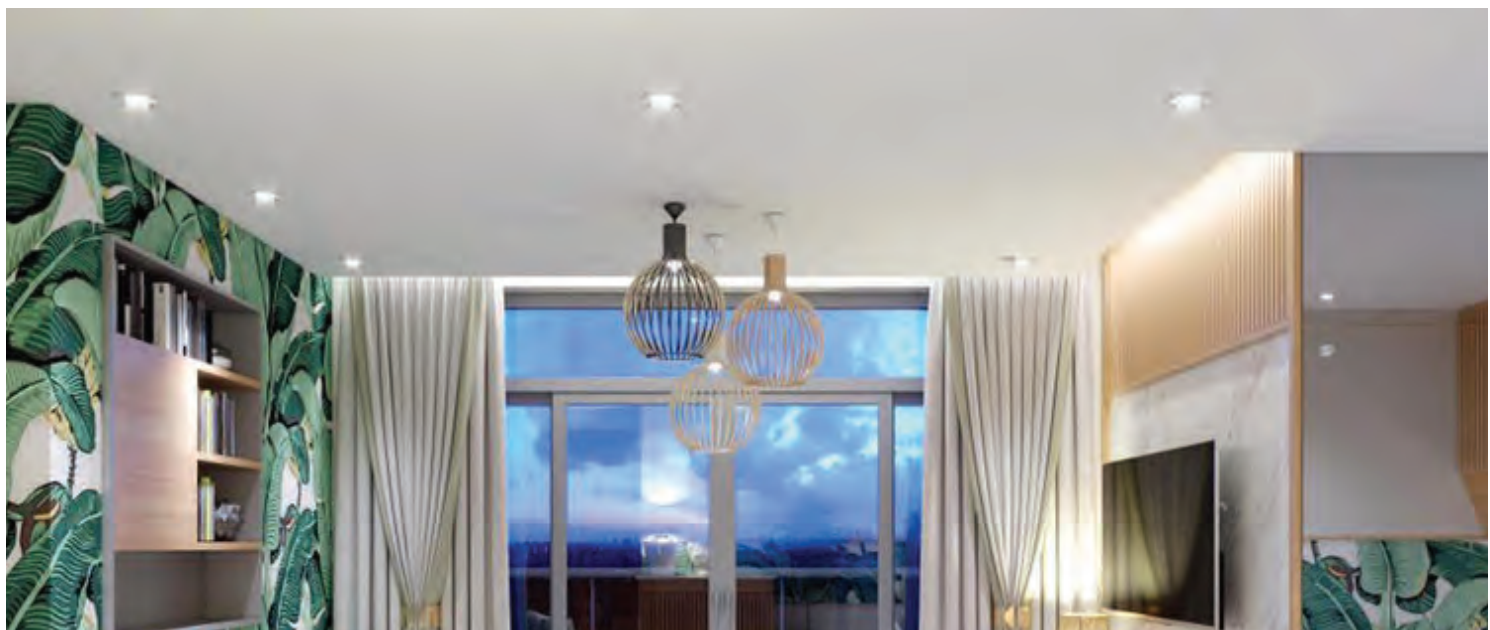

# LED Bulb Màu

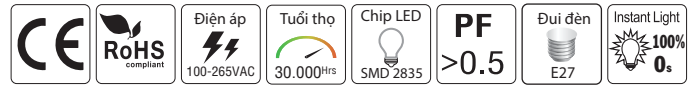

LED Bulb Màu	Mã hàng Model	Nhiệt độ màu CCT	Kích thước Size	Đóng gói Package	Đơn giá (VNĐ)
 <b>1.5W</b>	LBD-3R	màu đỏ	Ø45x70 mm	1 cái/hộp 100 cái/thùng	<b>38.000</b>
 <b>1.5W</b>	LBD-3OR	màu cam	Ø45x70 mm	1 cái/hộp 100 cái/thùng	<b>38.000</b>
 <b>1.5W</b>	LBD-3PK	màu hồng	Ø45x70 mm	1 cái/hộp 100 cái/thùng	<b>38.000</b>
 <b>1.5W</b>	LBD-3YL	màu vàng	Ø45x70 mm	1 cái/hộp 100 cái/thùng	<b>38.000</b>
 <b>1.5W</b>	LBD-3BL	màu xanh dương	Ø45x70 mm	1 cái/hộp 100 cái/thùng	<b>38.000</b>
 <b>1.5W</b>	LBD-3GR	màu xanh lá	Ø45x70 mm	1 cái/hộp 100 cái/thùng	<b>38.000</b>
 <b>1.5W</b>	LBD-3MK	màu trắng sữa	Ø45x70 mm	1 cái/hộp 100 cái/thùng	<b>38.000</b>

# LED Bulb Dây Tóc



LED Bulb Dây Tóc	Mã hàng Model	Quang thông Lumens	Nhiệt độ màu CCT	Đui đèn Base	Kích thước Size	Đóng gói Package	Đơn giá (VNĐ)
 <b>2.5W</b>	FLM-2/B35	250 Lm	2700K	E14	Ø35x98 mm	1 cái/hộp 100 cái/thùng	<b>68.200</b>
 <b>2.5W</b>	FLM-2/P45	250 Lm	2700K	E27	Ø45x80 mm	1 cái/hộp 100 cái/thùng	<b>75.100</b>
 <b>4W</b>	FLM-4/A60	470 Lm	2700K	E27	Ø60x105 mm	1 cái/hộp 50 cái/thùng	<b>92.400</b>
 <b>6W</b>	FLM-6/A60	806 Lm	2700K	E27	Ø60x105 mm	1 cái/hộp 50 cái/thùng	<b>120.100</b>
 <b>4W</b>	FLM-4/G95	470 Lm	2700K	E27	Ø95x138 mm	1 cái/hộp 20 cái/thùng	<b>156.000</b>
 <b>6W</b>	FLM-6/G95	806 Lm	2700K	E27	Ø95x138 mm	1 cái/hộp 20 cái/thùng	<b>173.300</b>
 <b>4W</b>	FLM-4/ST64	470 Lm	2700K	E27	Ø64x145 mm	1 cái/hộp 50 cái/thùng	<b>156.000</b>
 <b>6W</b>	FLM-6/ST64	806 Lm	2700K	E27	Ø64x145 mm	1 cái/hộp 50 cái/thùng	<b>173.300</b>

# LED Bulb Dây Tóc Màu



LED Bulb Dây Tóc Màu	Mã hàng Model	Nhiệt độ màu CCT	Kích thước Size	Đóng gói Package	Đơn giá (VNĐ)
 2.5W	FLM-3RD	Màu đỏ	Ø45x78 mm	1 cái/hộp 100 cái/thùng	75.100
 2.5W	FLM-3YL	Màu vàng	Ø45x78 mm	1 cái/hộp 100 cái/thùng	75.100
 2.5W	FLM-3GR	Màu xanh lá	Ø45x78 mm	1 cái/hộp 100 cái/thùng	75.100
 2.5W	FLM-3PK	Màu hồng	Ø45x78 mm	1 cái/hộp 100 cái/thùng	75.100
 2.5W	FLM-3OR	Màu cam	Ø45x78 mm	1 cái/hộp 100 cái/thùng	75.100
 2.5W	FLM-3PU	Màu tím	Ø45x78 mm	1 cái/hộp 100 cái/thùng	75.100



**DIALux**  
German Technology





IP44



END-TO-END  
CONNECTABLE



STRONG PLUG

	Mã hàng Model	Số đui đèn	Tiêu chuẩn chống nước	Kích thước Size (m)	Đóng gói Package	Đơn giá (VNĐ)
	<b>DDCT5-10</b>	10 đui đèn E27 (không bao gồm bóng)	IP44	5m	1 cuộn/hộp	<b>574.000</b>
	<b>DDCT10-15</b>	15 đui đèn E27 (không bao gồm bóng)	IP44	10m	1 cuộn/hộp	<b>970.600</b>
	<b>DDCT10-20</b>	20 đui đèn E27 (không bao gồm bóng)	IP44	10m	1 cuộn/hộp	<b>1.077.600</b>



# LED RECESSED LIGHT / LED ÂM TRẦN

Seri RPL - RPL/3C	17-18		Seri SPL/DIM	29-29	
Seri RPL viền màu	19-19		Seri DLB	30-31	
Seri SPL	20-20		Seri DLV	32-32	
Seri RPE	21-22		Seri DLT	33-33	
Seri MRPL	23-24		Seri DLE	34-35	
Seri RP	25-26		Seri DLC	36-36	
Seri RPL2	27-27		Seri DLF	37-37	
Seri RPL/MS	28-28		Seri DLF2	38-38	
Seri RPL/DIM	28-28		Seri DL65	39-39	

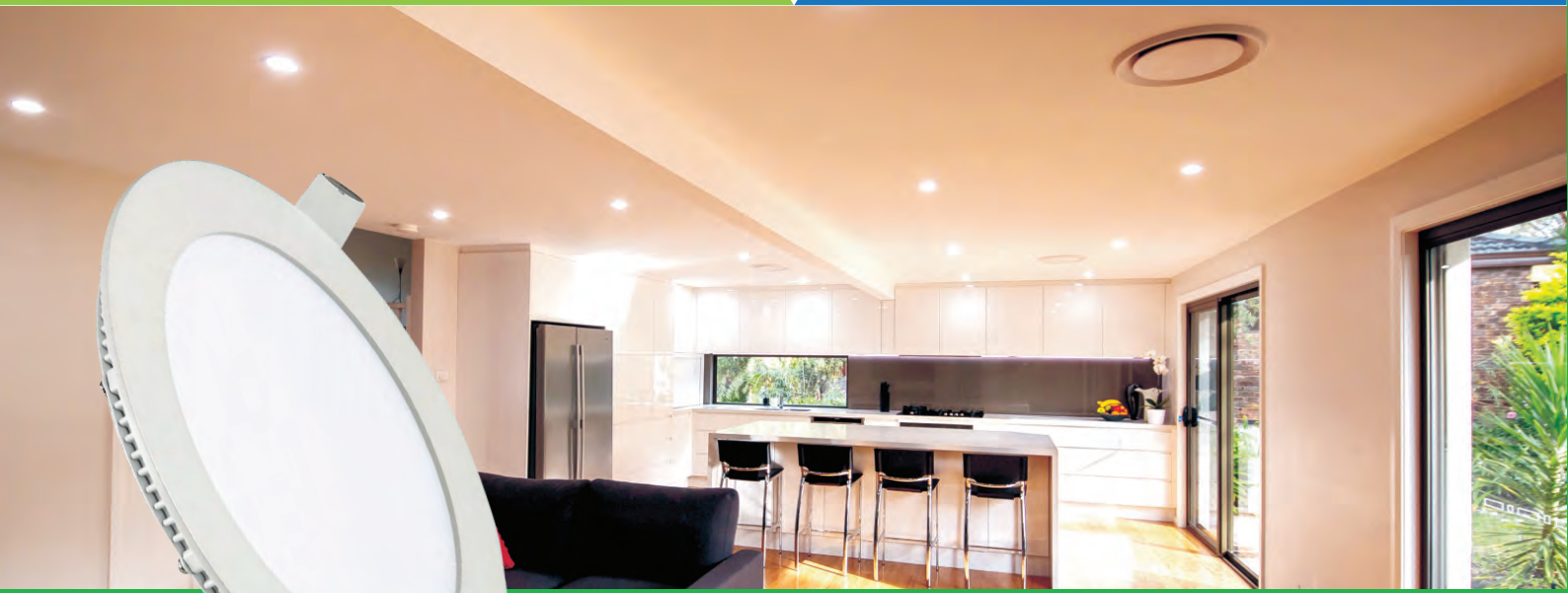

Đảm bảo ánh sáng luôn ổn định, độ bền cao



Kết nối Driver với đèn dễ dàng an toàn khi sử dụng

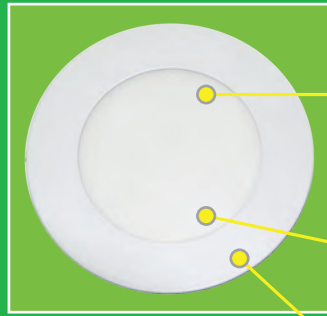

Bề mặt sử dụng tấm tán xạ ánh sáng đồng đều, không chói mắt

Tấm dẫn ánh sáng bằng nhựa PMMA - MITSUBISHI, cho ánh sáng phân bố đồng đều, không bị ngả vàng sau thời gian dài sử dụng



Viền đèn làm bằng hợp kim nhôm chống oxy hóa, chống rung, chống ăn mòn, tản nhiệt nhanh



Sử dụng LED chip cao cấp, có tuổi thọ và hiệu suất sáng cao.

Tấm ốp mặt sau bo góc không cho ánh sáng phát ra bên ngoài, chống bụi, tạo thẩm mỹ cao.

## Đặc tính sản phẩm

- Sản phẩm đạt tiêu chuẩn Châu Âu
- Thiết kế mỏng, nhỏ gọn, dễ dàng lắp đặt
- Không hồng ngoại & tia cực tím.
- Không nhấp nháy, khởi động tức thì
- Ánh sáng liên tục tốt cho thị lực
- Hiệu suất cao, tiết kiệm điện năng
- Thân thiện môi trường

## Hướng dẫn lắp đặt





1. Tạo lỗ khoét kích thước theo quy định.
2. Kết nối Driver với nguồn điện.
3. Cụp 2 thanh chắn nối lò xo lên trên, đưa đèn lên lỗ khoét.
4. Đẩy đèn vào khi bề mặt đèn chạm bề mặt trần nhà.





# LED Panel Âm Trần seri RPL



Seri RPL	Mã hàng Model	Quang thông Lumens	Nhiệt độ màu CCT	Kích thước Size	Đục lỗ Cut out	Đóng gói Package	Đơn giá (VNĐ)
 Ø110x25 mm <b>6W</b>	RPL-6ST RPL-6SN RPL-6SV	500 Lm	6000 - 6500K 4000 - 4500K 2800 - 3200K	Ø110x25 mm	Ø90 mm	1 cái/hộp 60 cái/thùng	<b>185.000</b>
	RPL-6S/3C		3000-6500-4000K				<b>257.100</b>
 Ø120x25 mm <b>6W</b>	RPL-6T RPL-6N RPL-6V	500 Lm	6000 - 6500K 4000 - 4500K 2800 - 3200K	Ø120x25 mm	Ø105 mm	1 cái/hộp 60 cái/thùng	<b>185.000</b>
	RPL-6/3C		3000-6500-4000K				<b>257.100</b>
 Ø120x25 mm <b>9W</b>	RPL-9ST RPL-9SN RPL-9SV	750 Lm	6000 - 6500K 4000 - 4500K 2800 - 3200K	Ø120x25 mm	Ø105 mm	1 cái/hộp 40 cái/thùng	<b>228.100</b>
	RPL-9S/3C		3000-6500-4000K				<b>268.800</b>
 Ø150x25 mm <b>9W</b>	RPL-9T RPL-9N RPL-9V	750 Lm	6000 - 6500K 4000 - 4500K 2800 - 3200K	Ø150x25 mm	Ø130 mm	1 cái/hộp 40 cái/thùng	<b>240.200</b>
	RPL-9/3C		3000-6500-4000K				<b>312.300</b>
 Ø150x25 mm <b>12W</b>	RPL-12ST RPL-12SN RPL-12SV	950 Lm	6000 - 6500K 4000 - 4500K 2800 - 3200K	Ø150x25 mm	Ø130 mm	1 cái/hộp 40 cái/thùng	<b>289.100</b>
	RPL-12S/3C		3000-6500-4000K				<b>335.300</b>
 Ø170x25 mm <b>12W</b>	RPL-12T RPL-12N RPL-12V	950 Lm	6000 - 6500K 4000 - 4500K 2800 - 3200K	Ø170x25 mm	Ø150 mm	1 cái/hộp 40 cái/thùng	<b>294.300</b>
	RPL-12/3C		3000-6500-4000K				<b>388.000</b>
 Ø190x25 mm <b>15W</b>	RPL-15T RPL-15N RPL-15V	1300 Lm	6000 - 6500K 4000 - 4500K 2800 - 3200K	Ø190x25 mm	Ø180 mm	1 cái/hộp 30 cái/thùng	<b>396.400</b>
	RPL-15/3C		3000-6500-4000K				<b>517.800</b>
 Ø225x25 mm <b>18W</b>	RPL-18T RPL-18N RPL-18V	1500 Lm	6000 - 6500K 4000 - 4500K 2800 - 3200K	Ø225x25 mm	Ø205 mm	1 cái/hộp 20 cái/thùng	<b>468.500</b>
	RPL-18/3C		3000-6500-4000K				<b>616.300</b>
 Ø300x25 mm <b>24W</b>	RPL-24T RPL-24N RPL-24V	1800 Lm	6000 - 6500K 4000 - 4500K 2800 - 3200K	Ø300x25 mm	Ø280 mm	1 cái/hộp 10 cái/thùng	<b>600.600</b>
	RPL-24/3C		3000-6500-4000K				<b>858.900</b>







**New****LED Panel Âm Trần seri RPL - Viên Màu**

<b>Seri RPL viên vàng</b>	Mã hàng Model	Quang thông Lumens	Nhiệt độ màu CCT	Kích thước Size	Đục lỗ Cut out	Đóng gói Package	Đơn giá (VNĐ)
 Ø110x25 mm <b>7W</b>	RPL-7T/G	550 Lm	6000 - 6500K	Ø110x25 mm	Ø90 mm	1 cái/hộp 60 cái/thùng	<b>217.000</b>
	RPL-7/3C/G		3000-6500-4000K				<b>266.000</b>
 Ø120x25 mm <b>9W</b>	RPL-9ST/G	750 Lm	6000 - 6500K	Ø120x25 mm	Ø105 mm	1 cái/hộp 40 cái/thùng	<b>249.400</b>
	RPL-9S/3C/G		3000-6500-4000K				<b>320.600</b>
 Ø150x25 mm <b>9W</b>	RPL-9T/G	750 Lm	6000 - 6500K	Ø150x25 mm	Ø130 mm	1 cái/hộp 40 cái/thùng	<b>280.700</b>
	RPL-9/3C/G		3000-6500-4000K				<b>360.200</b>
 Ø150x25 mm <b>12W</b>	RPL-12ST/G	950 Lm	6000 - 6500K	Ø150x25 mm	Ø130 mm	1 cái/hộp 40 cái/thùng	<b>327.900</b>
	RPL-12S/3C/G		3000-6500-4000K				<b>408.300</b>

<b>Seri RPL viên bạc</b>	Mã hàng Model	Quang thông Lumens	Nhiệt độ màu CCT	Kích thước Size	Đục lỗ Cut out	Đóng gói Package	Đơn giá (VNĐ)
 Ø110x25 mm <b>7W</b>	RPL-7T/S	550 Lm	6000 - 6500K	Ø110x25 mm	Ø90 mm	1 cái/hộp 60 cái/thùng	<b>217.000</b>
	RPL-7/3C/S		3000-6500-4000K				<b>266.000</b>
 Ø120x25 mm <b>9W</b>	RPL-9ST/S	750 Lm	6000 - 6500K	Ø120x25 mm	Ø105 mm	1 cái/hộp 40 cái/thùng	<b>249.400</b>
	RPL-9S/3C/S		3000-6500-4000K				<b>320.600</b>
 Ø150x25 mm <b>9W</b>	RPL-9T/S	750 Lm	6000 - 6500K	Ø150x25 mm	Ø130 mm	1 cái/hộp 40 cái/thùng	<b>280.700</b>
	RPL-9/3C/S		3000-6500-4000K				<b>360.200</b>
 Ø150x25 mm <b>12W</b>	RPL-12ST/S	950 Lm	6000 - 6500K	Ø150x25 mm	Ø130 mm	1 cái/hộp 40 cái/thùng	<b>327.900</b>
	RPL-12S/3C/S		3000-6500-4000K				<b>408.300</b>

# LED Panel Âm Trần seri SPL



Seri SPL	Mã hàng Model	Quang thông Lumens	Nhiệt độ màu CCT	Kích thước Size	Đục lỗ Cut out	Đóng gói Package	Đơn giá (VNĐ)
	SPL-6T SPL-6V	500 Lm	6000 - 6500K 2800 - 3200K	120x120x25 mm	105x105 mm	1 cái/hộp 60 cái/thùng	<b>191.000</b>
	SPL-9T SPL-9V	750 Lm	6000 - 6500K 2800 - 3200K	150x150x25 mm	130x130 mm	1 cái/hộp 40 cái/thùng	<b>247.400</b>
	SPL-12T SPL-12V	950 Lm	6000 - 6500K 2800 - 3200K	170x170x25 mm	150x150 mm	1 cái/hộp 40 cái/thùng	<b>304.000</b>
	SPL-15T SPL-15V	1300 Lm	6000 - 6500K 2800 - 3200K	190x190x25 mm	180x180 mm	1 cái/hộp 30 cái/thùng	<b>404.900</b>
	SPL-18T SPL-18V	1500 Lm	6000 - 6500K 2800 - 3200K	225x225x25 mm	205x205 mm	1 cái/hộp 20 cái/thùng	<b>480.500</b>
	SPL-24T SPL-24V	1800 Lm	6000 - 6500K 2800 - 3200K	300x300x25 mm	275x275 mm	1 cái/hộp 10 cái/thùng	<b>625.900</b>

## MINI PANEL SERI RPE

- Thiết kế 2 trong 1, lắp âm và lắp nổi.
- Tấm dẫn ánh sáng bằng nhựa PMMA - **MITSUBISHI**, cho ánh sáng phân bố đồng đều, không bị ngả vàng sau thời gian dài sử dụng.
- Lắp nhiều đèn cho 1 dây một cách nhanh chóng.
- Ánh sáng 3 màu.
- Có khung riêng cho panel nổi.
- Giảm thời gian lắp đặt, tiết kiệm chi phí.

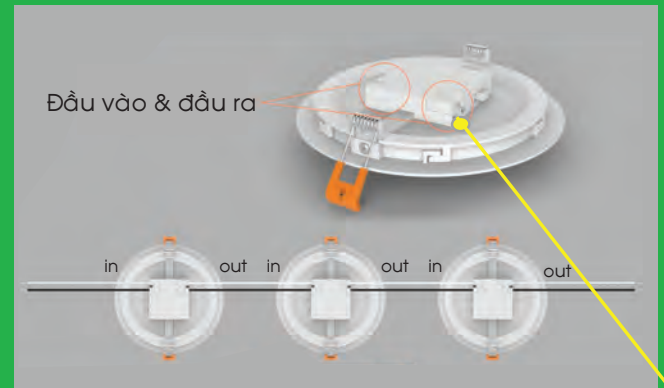

Lắp nhiều đèn cho 1 dây một cách nhanh chóng



Ánh sáng vàng



Ánh sáng trung tính



Ánh sáng trắng

## 2 trong 1 có thể lắp âm và lắp nổi

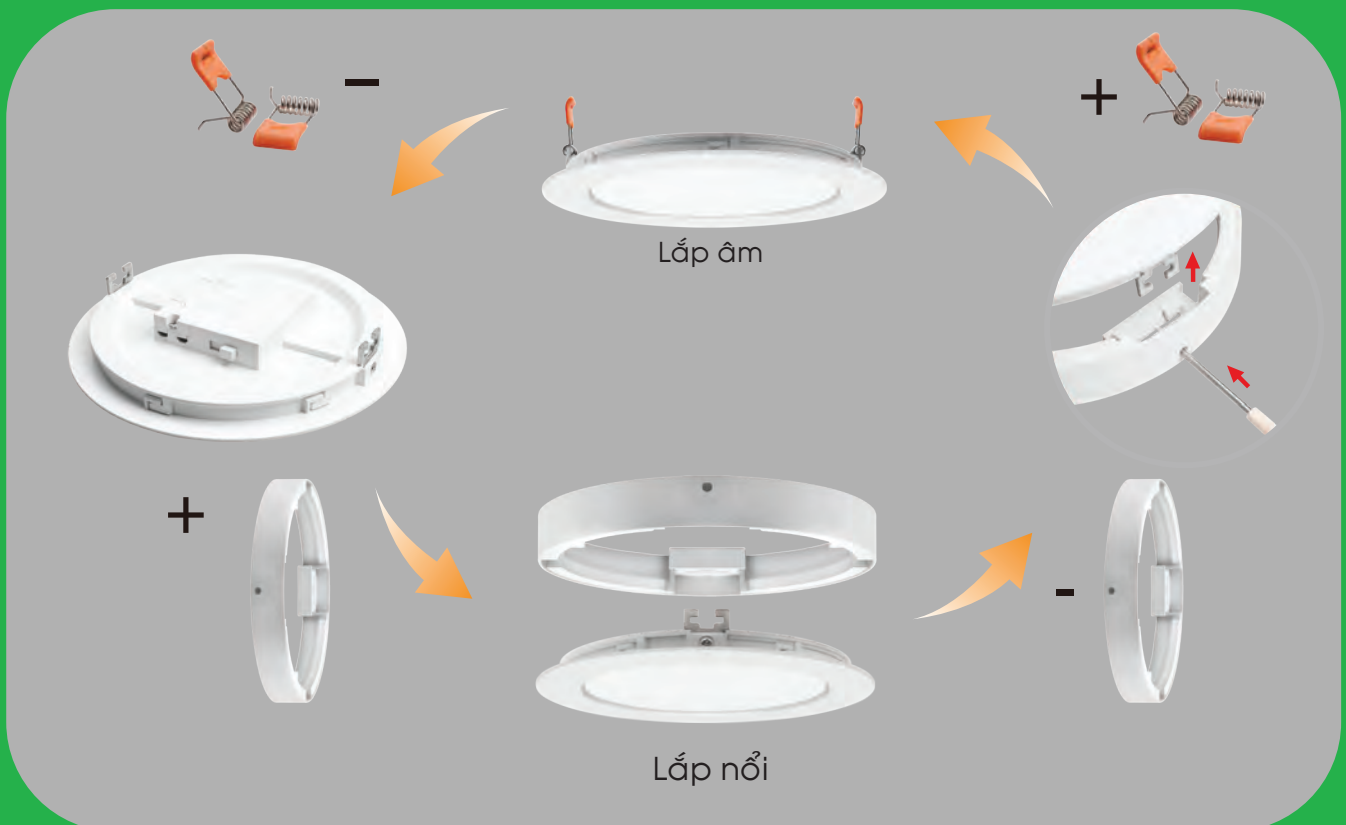





# LED Panel Âm Trần seri RPE



Seri RPE	Mã hàng Model	Quang thông Lumens	Nhiệt độ màu CCT	Kích thước Size	Đục lỗ Cut out	Đóng gói Package	Đơn giá (VNĐ)
	RPE-6T RPE-6V	500 Lm	6000 - 6500K 2800 - 3200K	Ø150x25mm	Ø133mm	1 cái/hộp 60 cái/thùng	<b>167.000</b>
	RPE-9T RPE-9V	750 Lm	6000 - 6500K 2800 - 3200K	Ø150x25mm	Ø133mm	1 cái/hộp 60 cái/thùng	<b>201.800</b>
	RPE-12T RPE-12V	950 Lm	6000 - 6500K 2800 - 3200K	Ø170x25mm	Ø152mm	1 cái/hộp 40 cái/thùng	<b>248.700</b>
	RPE-18T RPE-18V	1500 Lm	6000 - 6500K 2800 - 3200K	Ø223x25mm	Ø203mm	1 cái/hộp 20 cái/thùng	<b>359.200</b>
	RPE-24T RPE-24V	1800 Lm	6000 - 6500K 2800 - 3200K	Ø296x25mm	Ø279mm	1 cái/hộp 10 cái/thùng	<b>514.100</b>

Seri RPE 3 màu	Mã hàng Model	Quang thông Lumens	Nhiệt độ màu CCT	Kích thước Size	Đục lỗ Cut out	Đóng gói Package	Đơn giá (VNĐ)
	RPE-6/3C	500 Lm	3000-6500-4000K	Ø150x25mm	Ø133mm	1 cái/hộp 60 cái/thùng	<b>239.100</b>
	RPE-9/3C	750 Lm	3000-6500-4000K	Ø150x25mm	Ø133mm	1 cái/hộp 60 cái/thùng	<b>273.800</b>
	RPE-12/3C	950 Lm	3000-6500-4000K	Ø170x25mm	Ø152mm	1 cái/hộp 40 cái/thùng	<b>342.400</b>
	RPE-18/3C	1500 Lm	3000-6500-4000K	Ø223x25mm	Ø203mm	1 cái/hộp 20 cái/thùng	<b>523.700</b>
	RPE-24/3C	1800 Lm	3000-6500-4000K	Ø296x25mm	Ø279mm	1 cái/hộp 10 cái/thùng	<b>729.100</b>

Khung lắp nổi	Mã hàng Model	Đơn giá (VNĐ)
	<b>SRPE-9</b> Khung lắp nổi dùng cho RPE 6W & 9W cao 25mm	<b>57.800</b>
	<b>SRPE-12</b> Khung lắp nổi dùng cho RPE 12W cao 25mm	<b>69.300</b>

Khung lắp nổi	Mã hàng Model	Đơn giá (VNĐ)
	<b>SRPE-18</b> Khung lắp nổi dùng cho RPE 18W cao 25mm	<b>80.900</b>
	<b>SRPE-24</b> Khung lắp nổi dùng cho RPE 24W cao 25mm	<b>92.400</b>

- Có thể lắp nổi hoặc lắp âm.
- 3 chế độ màu : trắng, vàng, trung tính.
- Siêu mỏng, độ dày chỉ 15mm.
- Có 5 viền màu thích hợp.
- Tản nhiệt nhôm bên trong.
- Vừa vận với tất cả cỡ khoét trần do có cấu trúc lò xo di chuyển
- Dễ lắp đặt và tháo rời.
- Khoét lỗ tròn hoặc lỗ vuông đều lắp đặt được.

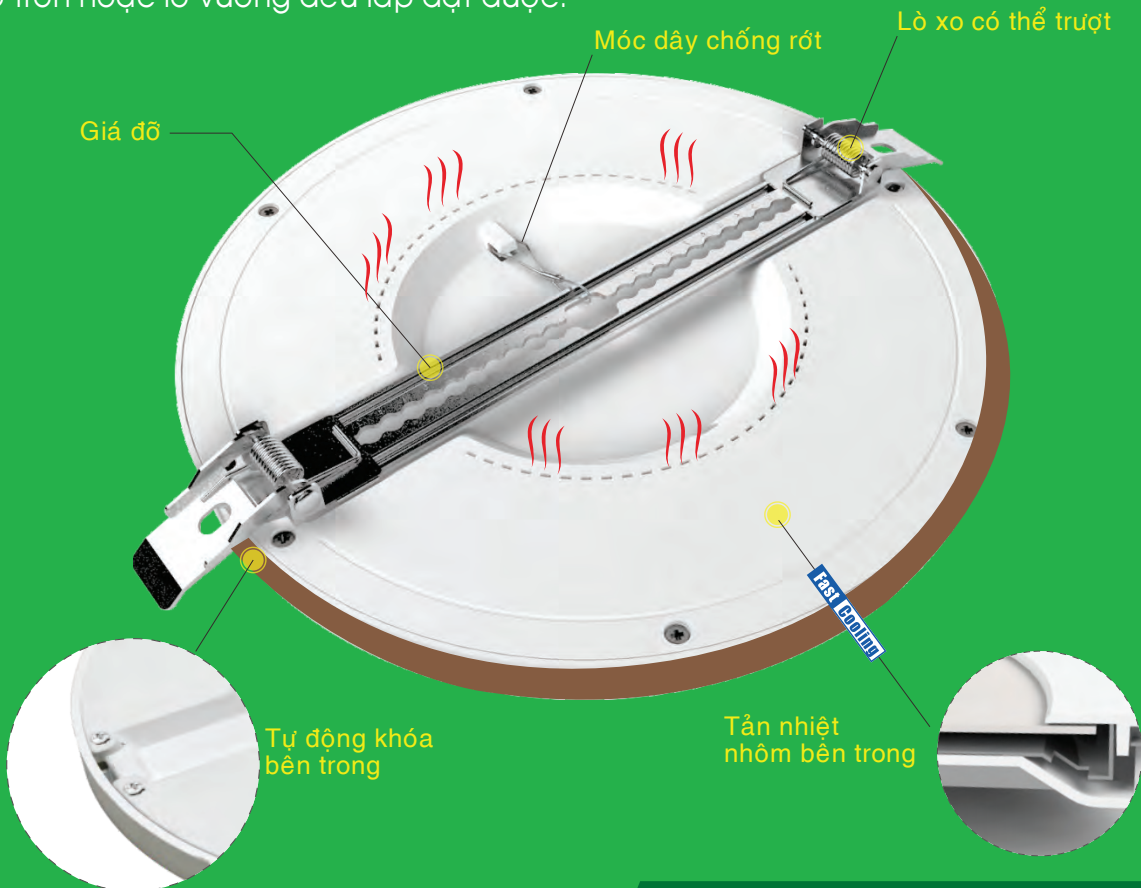
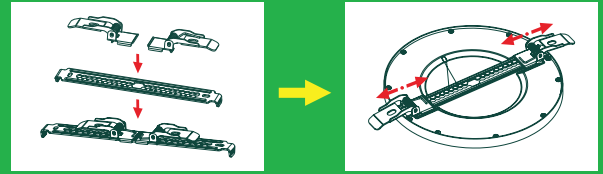

## Viền Màu LED Panel Đa Năng



Viền màu niken (NL)



Viền màu đỏ sẫm (RG)



Viền màu bạc (SL)



Viền màu vàng đồng (BR)







Viền màu đen (BL)



# LED Panel Đa Năng seri MRPL



Seri MRPL	Mã hàng Model	Quang thông Lumens	Nhiệt độ màu CCT	Kích thước Size	Đục lỗ Cut out	Đóng gói Package	Đơn giá (VNĐ)
 <b>6W</b>	MRPL-6/3C	470 Lm	3000-6500-4000K	Ø140x15 mm	Ø55<->100 mm □ 55x55 mm □ 85x85 mm	1 cái/hộp 60 cái/thùng	<b>322.300</b>
 <b>12W</b>	MRPL-12/3C	1060 Lm	3000-6500-4000K	Ø165x15 mm	Ø55<->125 mm □ 55x55 mm □ 100x100 mm	1 cái/hộp 40 cái/thùng	<b>426.300</b>
 <b>18W</b>	MRPL-18/3C	1650 Lm	3000-6500-4000K	Ø217x15 mm	Ø55<->175 mm □ 55x55 mm □ 140x140 mm	1 cái/hộp 20 cái/thùng	<b>600.600</b>
 <b>24W</b>	MRPL-24/3C	2500 Lm	3000-6500-4000K	Ø290x15 mm	Ø60<->250 mm □ 60x60 mm □ 190x190 mm	1 cái/hộp 10 cái/thùng	<b>851.300</b>

Viên LED Panel Đa Năng	Diễn giải	Đơn giá (VNĐ)	Viên LED Panel Đa Năng	Diễn giải	Đơn giá (VNĐ)
 <b>6W</b>	BD-6/RG: Màu đỏ sẫm BD-6/SL: Màu bạc BD-6/BR: Màu vàng đồng BD-6/NL: Màu niken BD-6/BL: Màu đen	<b>92.400</b>	 <b>18W</b>	BD-18/RG: Màu đỏ sẫm BD-18/SL: Màu bạc BD-18/BR: Màu vàng đồng BD-18/NL: Màu niken BD-18/BL: Màu đen	<b>143.200</b>
 <b>12W</b>	BD-12/RG: Màu đỏ sẫm BD-12/SL: Màu bạc BD-12/BR: Màu vàng đồng BD-12/NL: Màu niken BD-12/BL: Màu đen	<b>114.400</b>	 <b>24W</b>	BD-24/RG: Màu đỏ sẫm BD-24/SL: Màu bạc BD-24/BR: Màu vàng đồng BD-24/NL: Màu niken BD-24/BL: Màu đen	<b>205.600</b>

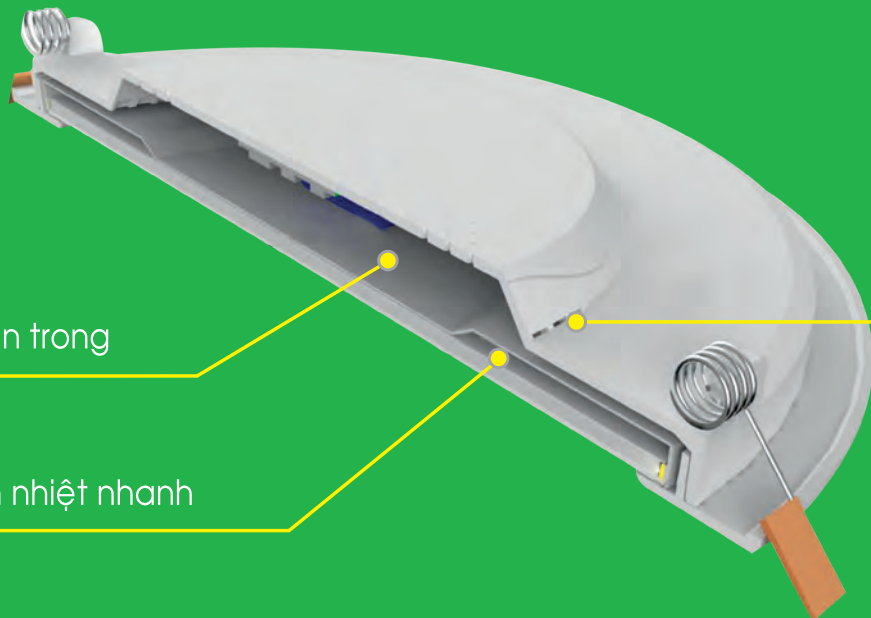

Driver thiết kế bên trong

Nhôm tản nhiệt nhanh

Lỗ thông hơi

**\* Thiết kế nhỏ, gọn, lắp đặt nhanh**

**\* Tích hợp Driver bên trong, tiết kiệm không gian lắp đặt**

## Đặc tính sản phẩm





- Sản phẩm đạt tiêu chuẩn Châu Âu.
- Thiết kế mỏng, nhỏ gọn.
- Driver tích hợp bên trong đèn.
- Khởi động tức thì, ánh sáng liên tục không nhấp nháy.
- Không tia hồng ngoại & tia cực tím.
- Không chói mắt, tốt cho thị lực.
- Hiệu suất cao, tiêu thụ điện năng ít.
- Thân thiện với môi trường.

## Hướng dẫn lắp đặt

1. Tạo lỗ khoét kích thước theo hướng dẫn.
2. Cạy 2 thanh chắn nổi lò xo lên trên, đưa đèn lên lỗ khoét.
3. Đẩy đèn vào khi bề mặt đèn chạm bề mặt trần nhà.

# LED Panel Âm Trần seri RP





Seri RP	Mã hàng Model	Quang thông Lumens	Nhiệt độ màu CCT	Kích thước Size	Đục lỗ Cut out	Đóng gói Package	Đơn giá (VNĐ)
	RP-6T RP-6N RP-6V	500 Lm	6000 - 6500K 4000 - 4500K 2800 - 3200K	Ø120x25 mm	Ø105 mm	1 cái/hộp 60 cái/thùng	<b>160.600</b>
	RP-9T RP-9N RP-9V	750 Lm	6000 - 6500K 4000 - 4500K 2800 - 3200K	Ø150x25 mm	Ø130 mm	1 cái/hộp 60 cái/thùng	<b>194.000</b>
	RP-12T RP-12N RP-12V	950 Lm	6000 - 6500K 4000 - 4500K 2800 - 3200K	Ø170x25 mm	Ø150 mm	1 cái/hộp 40 cái/thùng	<b>239.100</b>
	RP-18T RP-18N RP-18V	1500 Lm	6000 - 6500K 4000 - 4500K 2800 - 3200K	Ø225x25 mm	Ø205 mm	1 cái/hộp 20 cái/thùng	<b>345.400</b>
	RP-24T RP-24N RP-24V	1800 Lm	6000 - 6500K 4000 - 4500K 2800 - 3200K	Ø300x25 mm	Ø275 mm	1 cái/hộp 10 cái/thùng	<b>494.300</b>

# LED Panel Âm Trần Seri RPL2

**New**





Seri RPL2	Mã hàng Model	Quang thông Lumens	Nhiệt độ màu CCT	Kích thước Size	Đục lỗ Cut out	Đóng gói Package	Đơn giá (VNĐ)
 <b>6W</b>	RPL2-6T RPL2-6N RPL2-6V	600Lm	6000 - 6500K 4000 - 4500K 2800 - 3200K	Ø120x32mm	Ø100mm	1 cái/hộp 60 cái/thùng	<b>158.000</b>
	RPL2-6/3C		6500-3000-4000K				<b>189.000</b>
 <b>9W</b>	RPL2-9T RPL2-9N RPL2-9V	900Lm	6000 - 6500K 4000 - 4500K 2800 - 3200K	Ø147x32mm	Ø125mm	1 cái/hộp 40 cái/thùng	<b>187.400</b>
	RPL2-9/3C		6500-3000-4000K				<b>211.000</b>
 <b>12W</b>	RPL2-12T RPL2-12N RPL2-12V	1200 Lm	6000 - 6500K 4000 - 4500K 2800 - 3200K	Ø170x32mm	Ø150mm	1 cái/hộp 40 cái/thùng	<b>232.900</b>
	RPL2-12/3C		6500-3000-4000K				<b>264.400</b>
 <b>18W</b>	RPL2-18T RPL2-18N RPL2-18V	1800 Lm	6000 - 6500K 4000 - 4500K 2800 - 3200K	Ø220x32mm	Ø195mm	1 cái/hộp 20 cái/thùng	<b>348.100</b>
	RPL2-18/3C		6500-3000-4000K				<b>337.200</b>



# LED Panel Cảm Biến Chuyển Động, LED Panel Điều Chỉnh Độ Sáng



## Panel Âm Trần cảm biến chuyển động Seri RPL/MS

	Mã hàng Model	Quang thông Lumens	Nhiệt độ màu CCT	Kích thước Size	Đục lỗ Cut out	Đóng gói Package	Đơn giá (VNĐ)
 <b>12W</b>	RPL-12T/MS	950 Lm	6000 - 6500K	Ø170x25 mm	Ø150 mm	1 cái/hộp 40 cái/thùng	<b>646.200</b>
 <b>18W</b>	RPL-18T/MS	1500 Lm	6000 - 6500K	Ø225x25 mm	Ø205 mm	1 cái/hộp 20 cái/thùng	<b>780.800</b>

## Panel Âm Trần điều chỉnh độ sáng Seri RPL/DIM

	Mã hàng Model	Quang thông Lumens	Nhiệt độ màu CCT	Kích thước Size	Đục lỗ Cut out	Đóng gói Package	Đơn giá (VNĐ)
 <b>6W</b>	RPL-6T/DIM	500 Lm	6000 - 6500K	Ø120x25 mm	Ø105 mm	1 cái/hộp 60 cái/thùng	<b>487.700</b>
	RPL-6N/DIM		4000 - 4500K				
	RPL-6V/DIM		2800 - 3200K				
 <b>6W</b>	RPL-6ST/DIM	500 Lm	6000 - 6500K	Ø110x25 mm	Ø90 mm	1 cái/hộp 60 cái/thùng	<b>487.700</b>
	RPL-6SN/DIM		4000 - 4500K				
	RPL-6SV/DIM		2800 - 3200K				
 <b>9W</b>	RPL-9T/DIM	750 Lm	6000 - 6500K	Ø150x25 mm	Ø130 mm	1 cái/hộp 40 cái/thùng	<b>563.600</b>
	RPL-9N/DIM		4000 - 4500K				
	RPL-9V/DIM		2800 - 3200K				
 <b>12W</b>	RPL-12T/DIM	950 Lm	6000 - 6500K	Ø170x25 mm	Ø150 mm	1 cái/hộp 40 cái/thùng	<b>622.700</b>
	RPL-12N/DIM		4000 - 4500K				
	RPL-12V/DIM		2800 - 3200K				
 <b>15W</b>	RPL-15T/DIM	1300 Lm	6000 - 6500K	Ø190x25 mm	Ø180 mm	1 cái/hộp 30 cái/thùng	<b>690.100</b>
	RPL-15N/DIM		4000 - 4500K				
	RPL-15V/DIM		2800 - 3200K				
<b>18W</b>	RPL-18T/DIM	1500 Lm	6000 - 6500K	Ø225x25 mm	Ø205 mm	1 cái/hộp 20 cái/thùng	<b>795.600</b>
	RPL-18N/DIM		4000 - 4500K				
	RPL-18V/DIM		2800 - 3200K				
<b>24W</b>	RPL-24T/DIM RPL-24N/DIM RPL-24V/DIM	1800 Lm	6000 - 6500K 4000 - 4500K 2800 - 3200K	Ø300x25 mm	Ø280 mm	1 cái/hộp 10 cái/thùng	<b>1.003.100</b>

## Công tắc điều chỉnh độ sáng đèn LED (Dimmer)

	Mã hàng Model	Đơn giá Price		Mã hàng Model	Đơn giá Price		Mã hàng Model	Đơn giá Price
	AV200-LED	698.800		A6V200-LED	698.800		ASV200-LED	914.800

# LED Panel Điều chỉnh Độ Sáng seri SPL



## Panel Âm Trần điều chỉnh độ sáng Seri SPL/DIM

	Mã hàng Model	Quang thông Lumens	Nhiệt độ màu CCT	Kích thước Size	Đục lỗ Cut out	Đóng gói Package	Đơn giá (VNĐ)
	SPL-6T/DIM SPL-6V/DIM	500 Lm	6000 - 6500K 2800 - 3200K	120x120x25 mm	105x105 mm	1 cái/hộp 60 cái/thùng	<b>504.600</b>
	SPL-9T/DIM SPL-9V/DIM	750 Lm	6000 - 6500K 2800 - 3200K	150x150x25 mm	130x130 mm	1 cái/hộp 40 cái/thùng	<b>582.200</b>
	SPL-12T/DIM SPL-12V/DIM	950 Lm	6000 - 6500K 2800 - 3200K	170x170x25 mm	150x150 mm	1 cái/hộp 40 cái/thùng	<b>640.000</b>
	SPL-15T/DIM SPL-15V/DIM	1300 Lm	6000 - 6500K 2800 - 3200K	190x190x25 mm	180x180 mm	1 cái/hộp 30 cái/thùng	<b>709.200</b>
	SPL-18T/DIM SPL-18V/DIM	1500 Lm	6000 - 6500K 2800 - 3200K	225x225x25 mm	205x205 mm	1 cái/hộp 20 cái/thùng	<b>847.400</b>
	SPL-24T/DIM SPL-24V/DIM	1800 Lm	6000 - 6500K 2800 - 3200K	300x300x25 mm	275x275 mm	1 cái/hộp 10 cái/thùng	<b>1.029.100</b>

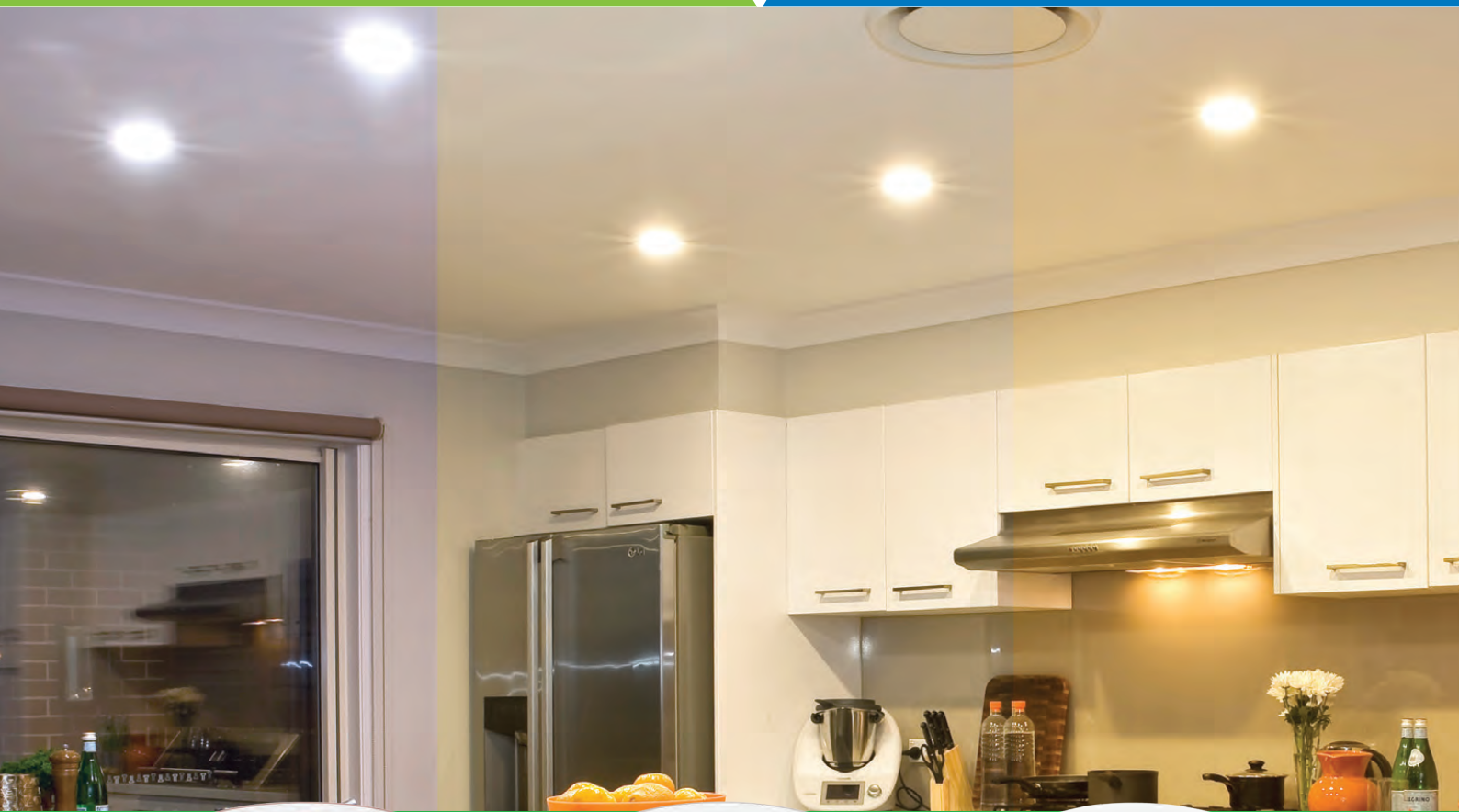

**Series DLV**



**Series DLB**



**Series DLT**



**DIALux**  
German Technology

## ĐẶC ĐIỂM KỸ THUẬT:

- Hiệu suất chiếu sáng cao, ánh sáng đều
- Đèn được đúc nhôm nguyên khối, sơn tĩnh điện cao cấp giúp tản nhiệt nhanh
- Đa dạng công suất và kích cỡ phù hợp cho nhu cầu sử dụng
- Ánh sáng: Trắng (6500K), trung tính (4000K), vàng (3000K), 3CCT
- 3 loại viền màu vàng, bạc, trắng
- Sử dụng bộ nguồn (driver) cách ly chống nhiễu tốt, giảm nhiệt độ cho bộ nguồn (driver), tăng tuổi thọ đèn
- Lắp đặt nhanh, tiết kiệm chi phí
- Tiết kiệm điện năng, thân thiện môi trường





## ỨNG DỤNG:

- Chiếu sáng hộ gia đình, căn hộ, văn phòng, trung tâm thương mại...

# LED Downlight Âm Trần seri DLB



## LED Downlight Viền Bạc





	Mã hàng Model	Nhiệt độ màu CCT	Quang thông Lumen	Kích thước Size	Đục lỗ Cut out	Đóng gói Package	Đơn giá (VNĐ)
 <p><b>5W</b></p>	<b>DLB-5T</b> <b>DLB-5N</b> <b>DLB-5V</b>	6000-6500K 4000-4500K 2800-3200K	550lm	Ø110x35mm	Ø74mm	1 cái/hộp 40 cái/thùng	<b>175.600</b>
	<b>DLB-5/3C</b>	6500-3000-4000K					<b>217.100</b>
 <p><b>7W</b></p>	<b>DLB-7T</b> <b>DLB-7N</b> <b>DLB-7V</b>	6000-6500K 4000-4500K 2800-3200K	770lm	Ø118x35mm	Ø80mm	1 cái/hộp 30 cái/thùng	<b>194.000</b>
	<b>DLB-7/3C</b>	6500-3000-4000K					<b>254.100</b>
 <p><b>9W</b></p> <p>(Ø118mm)</p>	<b>DLB-9T</b> <b>DLB-9N</b> <b>DLB-9V</b>	6000-6500K 4000-4500K 2800-3200K	990lm	Ø118x35mm	Ø80mm	1 cái/hộp 30 cái/thùng	<b>204.500</b>
	<b>DLB-9/3C</b>	6500-3000-4000K					<b>265.700</b>
 <p><b>9W</b></p> <p>(Ø140mm)</p>	<b>DLBL-9T</b> <b>DLBL-9N</b> <b>DLBL-9V</b>	6000-6500K 4000-4500K 2800-3200K	990lm	Ø140x35mm	Ø105mm	1 cái/hộp 20 cái/thùng	<b>225.300</b>
	<b>DLBL-9/3C</b>	6500-3000-4000K					<b>286.400</b>
 <p><b>12W</b></p>	<b>DLB-12T</b> <b>DLB-12N</b> <b>DLB-12V</b>	6000-6500K 4000-4500K 2800-3200K	1320lm	Ø140x35mm	Ø105mm	1 cái/hộp 20 cái/thùng	<b>283.000</b>
	<b>DLB-12/3C</b>	6500-3000-4000K					<b>346.500</b>



# LED Downlight âm trần seri DLV







## LED Downlight Viền Vàng

	Mã hàng Model	Nhiệt độ màu CCT	Quang thông Lumen	Kích thước Size	Đục lỗ Cut out	Đóng gói Package	Đơn giá (VNĐ)
 <p><b>5W</b></p>	DLV-5T DLV-5N DLV-5V	6000-6500K 4000-4500K 2800-3200K	550lm	Ø110x35mm	Ø74mm	1 cái/hộp 40 cái/thùng	175.600
	DLV-5/3C	6500-3000-4000K					217.100
 <p><b>7W</b></p>	DLV-7T DLV-7N DLV-7V	6000-6500K 4000-4500K 2800-3200K	770lm	Ø118x35mm	Ø80mm	1 cái/hộp 30 cái/thùng	194.000
	DLV-7/3C	6500-3000-4000K					254.100
 <p><b>9W</b></p> <p>(Ø118mm)</p>	DLV-9T DLV-9N DLV-9V	6000-6500K 4000-4500K 2800-3200K	990lm	Ø118x35mm	Ø80mm	1 cái/hộp 30 cái/thùng	204.500
	DLV-9/3C	6500-3000-4000K					265.700
 <p><b>9W</b></p> <p>(Ø140mm)</p>	DLVL-9T DLVL-9N DLVL-9V	6000-6500K 4000-4500K 2800-3200K	990lm	Ø140x35mm	Ø105mm	1 cái/hộp 20 cái/thùng	225.300
	DLVL-9/3C	6500-3000-4000K					286.400
 <p><b>12W</b></p>	DLV-12T DLV-12N DLV-12V	6000-6500K 4000-4500K 2800-3200K	1320lm	Ø140x35mm	Ø105mm	1 cái/hộp 20 cái/thùng	283.000
	DLV-12/3C	6500-3000-4000K					346.500

# LED Downlight âm trần seri DLT



## LED Downlight Viền Trắng

	Mã hàng Model	Nhiệt độ màu CCT	Quang thông Lumen	Kích thước Size	Đục lỗ Cut out	Đóng gói Package	Đơn giá (VNĐ)
	DLT-5T DLT-5N DLT-5V	6000-6500K 4000-4500K 2800-3200K	550lm	Ø110x35mm	Ø74mm	1 cái/hộp 40 cái/thùng	175.600
	DLT-5/3C	6500-3000-4000K					217.100
	DLT-7T DLT-7N DLT-7V	6000-6500K 4000-4500K 2800-3200K	770lm	Ø118x35mm	Ø80mm	1 cái/hộp 30 cái/thùng	194.000
	DLT-7/3C	6500-3000-4000K					254.100
 (Ø118mm)	DLT-9T DLT-9N DLT-9V	6000-6500K 4000-4500K 2800-3200K	990lm	Ø118x35mm	Ø80mm	1 cái/hộp 30 cái/thùng	204.500
	DLT-9/3C	6500-3000-4000K					265.700
 (Ø140mm)	DLTL-9T DLTL-9N DLTL-9V	6000-6500K 4000-4500K 2800-3200K	990lm	Ø140x35mm	Ø105mm	1 cái/hộp 20 cái/thùng	225.300
	DLTL-9/3C	6500-3000-4000K					286.400
	DLT-12T DLT-12N DLT-12V	6000-6500K 4000-4500K 2800-3200K	1320lm	Ø140x35mm	Ø105mm	1 cái/hộp 20 cái/thùng	283.000
	DLT-12/3C	6500-3000-4000K					346.500

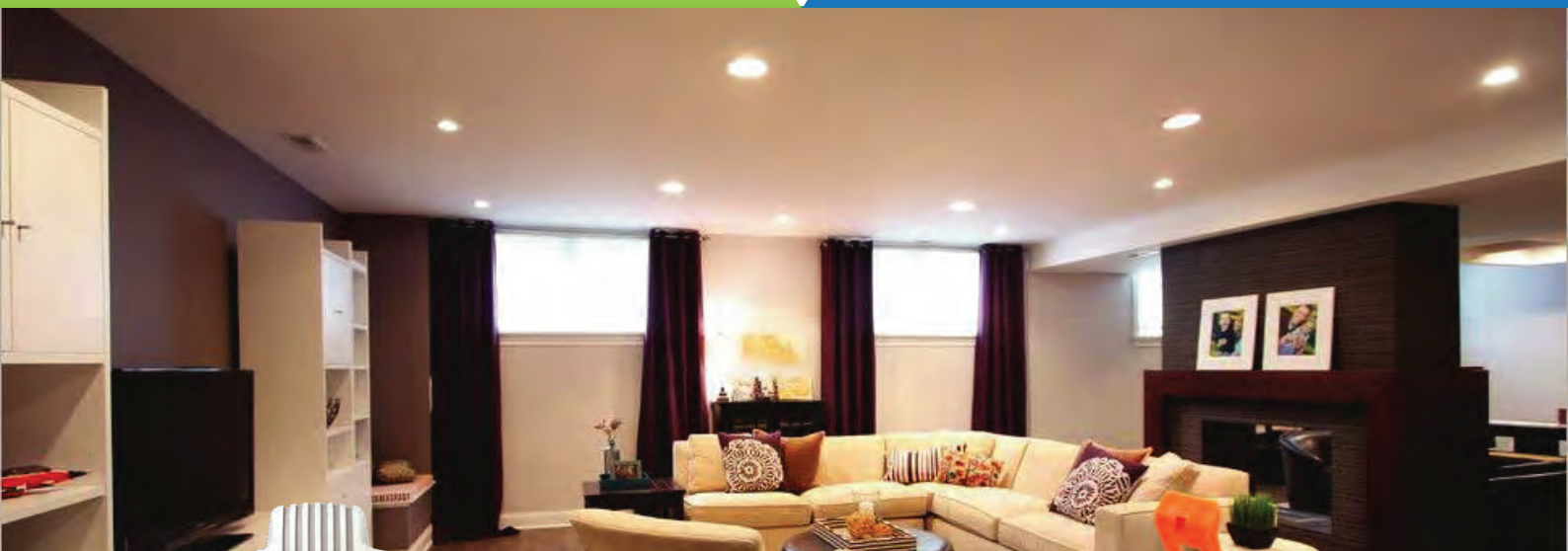

- Thiết kế 2 trong 1, lắp âm và lắp nổi
- Tấm dẫn sáng cho ánh sáng phân bố đồng đều, không bị ngả vàng sau thời gian dài sử dụng
- Hiệu suất chiếu sáng cao
- Ánh sáng 3 màu.
- Có khung riêng cho panel nổi.
- Giảm thời gian lắp đặt, tiết kiệm chi phí



**DIALux**  
German Technology

## 2 trong 1 có thể lắp âm và lắp nổi

**6W**



6000 - 6500K (Trắng)  
2800 - 3200K (Vàng)  
6000 - 3000 - 4000 (3 màu)

**9W**



6000 - 6500K (Trắng)  
2800 - 3200K (Vàng)  
6000 - 3000 - 4000 (3 màu)

**12W**



6000 - 6500K (Trắng)  
2800 - 3200K (Vàng)  
6000 - 3000 - 4000 (3 màu)

**18W**



6000 - 6500K (Trắng)  
2800 - 3200K (Vàng)  
6000 - 3000 - 4000 (3 màu)



Khung lắp nổi cho DLE







Downlight DLE







Downlight nổi DLE

# LED Downlight âm trần seri DLE - DLEL



Seri DLE	Mã hàng Model	Quang thông Lumens	Nhiệt độ màu CCT	Kích thước Size	Đục lỗ Cut out	Đóng gói Package	Đơn giá (VNĐ)
 6W	DLEL-6T DLEL-6V	600Lm	6000 - 6500K 2800 - 3200K	Ø102x50mm	Ø90mm	1 cái/hộp 40 cái/thùng	110.900
	DLEL-6/3C		6000-3000-4000K				151.300
 7W	DLE-7T DLE-7V	700Lm	6000 - 6500K 2800 - 3200K	Ø102x50mm	Ø90mm	1 cái/hộp 40 cái/thùng	110.900
	DLE-7/3C		6000-3000-4000K				151.300
 9W	DLEL-9T DLEL-9V	900Lm	6000 - 6500K 2800 - 3200K	Ø122x50mm	Ø100mm	1 cái/hộp 30 cái/thùng	130.500
	DLEL-9/3C		6000-3000-4000K				187.100
 12W	DLE-12T DLE-12V	1200Lm	6000 - 6500K 2800 - 3200K	Ø166x54mm	Ø150mm	1 cái/hộp 20 cái/thùng	189.400
	DLE-12/3C		6000-3000-4000K				283.000
 18W	DLE-18T DLE-18V	1800Lm	6000 - 6500K 2800 - 3200K	Ø216x55mm	Ø200mm	1 cái/hộp 10 cái/thùng	294.500
	DLE-18/3C		6000-3000-4000K				376.500





Khung lắp nổi	Mã hàng Model	Đơn giá (VNĐ)
 6W 7W	<b>SRDLE-6</b> Khung lắp nổi dùng cho DLEL 6W, DLE 7W cao 50mm	37.000
 9W	<b>SRDLE-9</b> Khung lắp nổi dùng cho DLEL 9W cao 50mm	43.900

Khung lắp nổi	Mã hàng Model	Đơn giá (VNĐ)
 12W	<b>SRDLE-12</b> Khung lắp nổi dùng cho DLE 12W cao 55mm	55.400
 18W	<b>SRDLE-18</b> Khung lắp nổi dùng cho DLE 18W cao 55mm	67.000

# LED Downlight âm trần seri DLC



Seri DLC	Mã hàng Model	Quang thông Lumens	Nhiệt độ màu CCT	Kích thước Size	Đục lỗ Cut out	Đóng gói Package	Đơn giá (VNĐ)
 <b>18W</b>	<b>DLC-18T</b>	2160 lm	6000 - 6500K	Ø225x64mm	Ø200mm	1 cái/hộp 8 cái/thùng	<b>537.100</b>
 <b>24W</b>	<b>DLC-24T</b>	2880 lm	6000 - 6500K	Ø225x64mm	Ø200mm	1 cái/hộp 8 cái/thùng	<b>577.500</b>

Seri DLC 3 màu	Mã hàng Model	Quang thông Lumens	Nhiệt độ màu CCT	Kích thước Size	Đục lỗ Cut out	Đóng gói Package	Đơn giá (VNĐ)
 <b>3 màu 6W</b>	<b>DLC-6/3C</b>	720 lm	6500-3000-4000K	Ø115x63mm	Ø90mm	1 cái/hộp 24 cái/thùng	<b>221.800</b>
 <b>3 màu 9W</b>	<b>DLC-9/3C</b>	1080 lm	6500-3000-4000K	Ø115x63mm	Ø90mm	1 cái/hộp 24 cái/thùng	<b>236.800</b>
 <b>3 màu 12W</b>	<b>DLC-12/3C</b>	1440 lm	6500-3000-4000K	Ø175x64mm	Ø150mm	1 cái/hộp 12 cái/thùng	<b>399.600</b>
 <b>3 màu 18W</b>	<b>DLC-18/3C</b>	2160 lm	6500-3000-4000K	Ø225x64mm	Ø200mm	1 cái/hộp 8 cái/thùng	<b>626.000</b>
 <b>3 màu 24W</b>	<b>DLC-24/3C</b>	2880 lm	6500-3000-4000K	Ø225x64mm	Ø200mm	1 cái/hộp 8 cái/thùng	<b>713.800</b>

## Viền đèn dùng cho DLC 6W - 9W





	Mã số / Diễn giải	Đơn giá (VNĐ)
	<b>RDLC9-GD</b> màu vàng đồng	<b>22.000</b>
	<b>RDLC9-CR</b> màu Crom	<b>22.000</b>
	<b>RDLC9-BL</b> màu xanh da trời	<b>22.000</b>

## Viền đèn dùng cho DLC 6W - 9W

	Mã số / Diễn giải	Đơn giá (VNĐ)
	<b>RDLC9-GR</b> màu xanh lá	<b>22.000</b>
	<b>RDLC9-PK</b> màu hồng	<b>22.000</b>
	<b>RDLC9-SL</b> màu bạc	<b>22.000</b>

# LED Downlight âm trần seri DLF







Seri DLF	Mã hàng Model	Quang thông Lumens	Nhiệt độ màu CCT	Kích thước Size	Đục lỗ Cut out	Đóng gói Package	Đơn giá (VNĐ)
 <b>7W</b>	<b>DLF-7T DLF-7V</b>	609 lm	6000k 3000k	Ø98x41mm	Ø80mm	1 cái/hộp 20 cái/thùng	<b>404.300</b>
 <b>12W</b>	<b>DLF-12T DLF-12V</b>	1200 lm	6000k 3000k	Ø113x44mm	Ø95mm	1 cái/hộp 20 cái/thùng	<b>492.000</b>
 <b>20W</b>	<b>DLF-20T DLF-20V</b>	1800 lm	6000k 3000k	Ø148x56mm	Ø125mm	1 cái/hộp 20 cái/thùng	<b>1.025.600</b>
 <b>25W</b>	<b>DLF-25T DLF-25V</b>	2500 lm	6000k 3000k	Ø198x68mm	Ø170mm	1 cái/hộp 20 cái/thùng	<b>1.153.900</b>
 <b>30W</b>	<b>DLF-30T DLF-30V</b>	2800 lm	6000k 3000k	Ø245x99mm	Ø225mm	1 cái/hộp 12 cái/thùng	<b>1.443.800</b>

# LED Downlight âm trần seri DLF2

**New**



Seri DLF2	Mã hàng Model	Quang thông Lumens	Nhiệt độ màu CCT	Kích thước Size	Đục lỗ Cut out	Đóng gói Package	Đơn giá (VNĐ)
	<b>DLF2-7T</b> <b>DLF2-7N</b>	630Lm	6000 - 6500K 4000 - 4500K	Ø87x50mm	Ø65mm	1 cái/hộp 50 cái/thùng	<b>213.400</b>
	<b>DLF2-12T</b> <b>DLF2-12N</b>	1080Lm	6000 - 6500K 4000 - 4500K	Ø120x50mm	Ø100mm	1 cái/hộp 40 cái/thùng	<b>260.200</b>
	<b>DLF2-20T</b> <b>DLF2-20N</b>	1800Lm	6000 - 6500K 4000 - 4500K	Ø172x70mm	Ø150mm	1 cái/hộp 24 cái/thùng	<b>372.800</b>
	<b>DLF2-30T</b> <b>DLF2-30N</b>	2700Lm	6000 - 6500K 4000 - 4500K	Ø230x95mm	Ø180mm	1 cái/hộp 8 cái/thùng	<b>536.800</b>
	<b>DLF2-40T</b> <b>DLF2-40N</b>	3600Lm	6000 - 6500K 4000 - 4500K	Ø230x95mm	Ø180mm	1 cái/hộp 8 cái/thùng	<b>598.300</b>





# LED Downlight Âm Trần Chống Ẩm IP65



- Đèn có hiệu suất cao 90 Lm/W
- Thân đèn làm nhôm cao cấp, phủ sơn tĩnh điện
- Thân đèn với khe tản nhiệt giúp tăng tuổi thọ đèn
- Đèn thiết kế tiêu chuẩn IP65 giúp chống nước, bụi bẩn

- Mặt đèn lõm giúp tăng chiều sâu cho chùm sáng
- Tiết kiệm điện năng, dễ dàng lắp đặt
- Không gian sang trọng, hài hòa
- Ứng dụng: Công trình nhà ở, Showroom, trung tâm thương mại...

## Seri DL65

	Mã hàng Model	Quang thông Lumens	Nhiệt độ màu CCT	Kích thước Size	Đục lỗ Cut out	Đóng gói Package	Đơn giá (VNĐ)
	DL65-12V	1080 lm	3000k	Ø95x98mm	Ø85mm	1 cái/hộp 48 cái/thùng	<b>1.054.600</b>
	DL65-20V	1800 lm	3000k	Ø125x120mm	Ø115mm	1 cái/hộp 27 cái/thùng	<b>1.582.400</b>
	DL65-30V	2700 lm	3000k	Ø150x132mm	Ø140mm	1 cái/hộp 18 cái/thùng	<b>2.042.000</b>



# LED SURFACE LIGHT / LED ỚP TRẦN





Seri SRPL	41-41		Seri SSPL/DIM	46-46	
Seri SSPL	41-41		Seri SRDL	49-50	
Seri SRPLB	42-42		Seri SSDL	49-50	
Seri SSPLB	42-42		Seri SRDLB	51-51	
Seri RPE	43-43		Seri SSDLB	51-51	
Seri MRPL	44-44		Seri DLE	52-52	
Seri SRPL/MS	45-45		Seri MCL	53-53	
Seri SSPL/MS	45-45		Seri CL, CL/3C	54-54	
Seri SRPL/DIM	46-46		Seri RCL, RCLH, SCL	55-55	

Thiết bị cảm biến chuyển động Wifi, Microwave, hồng ngoại, photocell 47-48





# LED Panel Ốp Trần seri SRPL-SSPL



## Seri SRPL (Thân đèn tròn màu trắng)

	Mã hàng Model	Quang thông Lumens	Nhiệt độ màu CCT	Kích thước Size	Đóng gói Package	Đơn giá (VNĐ)
	SRPL-6T SRPL-6V	500 Lm	6000 - 6500K 2800 - 3200K	Ø120x35 mm	1 cái/hộp 40 cái/thùng	265.100
	SRPL-6/3C		3000-6500-4000K			344.300
	SRPL-12T SRPL-12V	950 Lm	6000 - 6500K 2800 - 3200K	Ø170x35 mm	1 cái/hộp 30 cái/thùng	390.500
	SRPL-12/3C		3000-6500-4000K			508.200
	SRPL-18T SRPL-18V	1500 Lm	6000 - 6500K 2800 - 3200K	Ø217x35 mm	1 cái/hộp 20 cái/thùng	523.600
	SRPL-18/3C		3000-6500-4000K			680.900
	SRPL-24T SRPL-24V	1800 Lm	6000 - 6500K 2800 - 3200K	Ø300x35 mm	1 cái/hộp 10 cái/thùng	700.700
	SRPL-24/3C		3000-6500-4000K			910.800

## Seri SSPL (Thân đèn vuông màu trắng)

	Mã hàng Model	Quang thông Lumens	Nhiệt độ màu CCT	Kích thước Size	Đóng gói Package	Đơn giá (VNĐ)
	SSPL-6T SSPL-6V	500 Lm	6000 - 6500K 2800 - 3200K	120x120x35 mm	1 cái/hộp 40 cái/thùng	281.600
	SSPL-6/3C		3000-6500-4000K			366.300
	SSPL-12T SSPL-12V	950 Lm	6000 - 6500K 2800 - 3200K	170x170x35 mm	1 cái/hộp 30 cái/thùng	416.900
	SSPL-12/3C		3000-6500-4000K			542.300
	SSPL-18T SSPL-18V	1500 Lm	6000 - 6500K 2800 - 3200K	217x217x35 mm	1 cái/hộp 20 cái/thùng	554.400
	SSPL-18/3C		3000-6500-4000K			720.500
	SSPL-24T SSPL-24V	1800 Lm	6000 - 6500K 2800 - 3200K	300x300x35 mm	1 cái/hộp 10 cái/thùng	742.500
	SSPL-24/3C		3000-6500-4000K			965.800

# LED Panel Ốp Trần seri SRPLB-SSPLB



## Seri SRPLB (Thân đèn tròn màu đen)

	Mã hàng Model	Quang thông Lumens	Nhiệt độ màu CCT	Kích thước Size	Đóng gói Package	Đơn giá (VNĐ)
	SRPLB-18T SRPLB-18V	1500 Lm	6000 - 6500K 2800 - 3200K	Ø217x35 mm	1 cái/hộp 20 cái/thùng	576.400
	SRPLB-18/3C		3000-6500-4000K			749.100
	SRPLB-24T SRPLB-24V	1800 Lm	6000 - 6500K 2800 - 3200K	Ø300x35 mm	1 cái/hộp 10 cái/thùng	770.000
	SRPLB-24/3C		3000-6500-4000K			1.002.100

## Seri SSPLB (Thân đèn vuông màu đen)

	Mã hàng Model	Quang thông Lumens	Nhiệt độ màu CCT	Kích thước Size	Đóng gói Package	Đơn giá (VNĐ)
	SSPLB-18T SSPLB-18V	1500 Lm	6000 - 6500K 2800 - 3200K	217x217x35 mm	1 cái/hộp 20 cái/thùng	609.400
	SSPLB-18/3C		3000-6500-4000K			793.100
	SSPLB-24T SSPLB-24V	1800 Lm	6000 - 6500K 2800 - 3200K	300x300x35 mm	1 cái/hộp 10 cái/thùng	817.300
	SSPLB-24/3C		3000-6500-4000K			1.062.600







# LED Panel Ốp Trần Seri RPE



Seri RPE	Mã hàng Model	Quang thông Lumens	Nhiệt độ màu CCT	Kích thước Size	Đục lỗ Cut out	Đóng gói Package	Đơn giá (VNĐ)
	RPE-6T RPE-6V	500 Lm	6000 - 6500K 2800 - 3200K	Ø150x25mm	Ø133mm	1 cái/hộp 60 cái/thùng	<b>167.000</b>
	RPE-9T RPE-9V	750 Lm	6000 - 6500K 2800 - 3200K	Ø150x25mm	Ø133mm	1 cái/hộp 60 cái/thùng	<b>201.800</b>
	RPE-12T RPE-12V	950 Lm	6000 - 6500K 2800 - 3200K	Ø170x25mm	Ø152mm	1 cái/hộp 40 cái/thùng	<b>248.700</b>
	RPE-18T RPE-18V	1500 Lm	6000 - 6500K 2800 - 3200K	Ø223x25mm	Ø203mm	1 cái/hộp 20 cái/thùng	<b>359.200</b>
	RPE-24T RPE-24V	1800 Lm	6000 - 6500K 2800 - 3200K	Ø296x25mm	Ø279mm	1 cái/hộp 10 cái/thùng	<b>514.100</b>





Seri RPE 3 màu	Mã hàng Model	Quang thông Lumens	Nhiệt độ màu CCT	Kích thước Size	Đục lỗ Cut out	Đóng gói Package	Đơn giá (VNĐ)
	RPE-6/3C	500 Lm	3000-6500-4000K	Ø150x25mm	Ø133mm	1 cái/hộp 60 cái/thùng	<b>239.100</b>
	RPE-9/3C	750 Lm	3000-6500-4000K	Ø150x25mm	Ø133mm	1 cái/hộp 60 cái/thùng	<b>273.800</b>
	RPE-12/3C	950 Lm	3000-6500-4000K	Ø170x25mm	Ø152mm	1 cái/hộp 40 cái/thùng	<b>342.400</b>
	RPE-18/3C	1500 Lm	3000-6500-4000K	Ø223x25mm	Ø203mm	1 cái/hộp 20 cái/thùng	<b>523.700</b>
	RPE-24/3C	1800 Lm	3000-6500-4000K	Ø296x25mm	Ø279mm	1 cái/hộp 10 cái/thùng	<b>729.100</b>

Khung lắp nổi	Mã hàng Model	Đơn giá (VNĐ)
	<b>SRPE-9</b> Khung lắp nổi dùng cho RPE 6W & 9W cao 25mm	<b>57.800</b>
	<b>SRPE-12</b> Khung lắp nổi dùng cho RPE 12W cao 25mm	<b>69.300</b>

Khung lắp nổi	Mã hàng Model	Đơn giá (VNĐ)
	<b>SRPE-18</b> Khung lắp nổi dùng cho RPE 18W cao 25mm	<b>80.900</b>
	<b>SRPE-24</b> Khung lắp nổi dùng cho RPE 24W cao 25mm	<b>92.400</b>

# LED Panel Đa Năng seri MRPL





Seri MRPL	Mã hàng Model	Quang thông Lumens	Nhiệt độ màu CCT	Kích thước Size	Đục lỗ Cut out	Đóng gói Package	Đơn giá (VNĐ)
 <b>6W</b>	MRPL-6/3C	470 Lm	3000-6500-4000K	Ø140x15 mm	Ø55<->100 mm □ 55x55 mm □ 85x85 mm	1 cái/hộp 60 cái/thùng	<b>322.300</b>
 <b>12W</b>	MRPL-12/3C	1060 Lm	3000-6500-4000K	Ø165x15 mm	Ø55<->125 mm □ 55x55 mm □ 100x100 mm	1 cái/hộp 40 cái/thùng	<b>426.300</b>
 <b>18W</b>	MRPL-18/3C	1650 Lm	3000-6500-4000K	Ø217x15 mm	Ø55<->175 mm □ 55x55 mm □ 140x140 mm	1 cái/hộp 20 cái/thùng	<b>600.600</b>
 <b>24W</b>	MRPL-24/3C	2500 Lm	3000-6500-4000K	Ø290x15 mm	Ø60<->250 mm □ 60x60 mm □ 190x190 mm	1 cái/hộp 10 cái/thùng	<b>851.300</b>

Viên LED Panel Đa Năng	Diễn giải	Đơn giá (VNĐ)	Viên LED Panel Đa Năng	Diễn giải	Đơn giá (VNĐ)
 <b>6W</b>	BD-6/RG: Màu đỏ sẫm BD-6/SL: Màu bạc BD-6/BR: Màu vàng đồng BD-6/NL: Màu niken BD-6/BL: Màu đen	<b>92.400</b>	 <b>18W</b>	BD-18/RG: Màu đỏ sẫm BD-18/SL: Màu bạc BD-18/BR: Màu vàng đồng BD-18/NL: Màu niken BD-18/BL: Màu đen	<b>143.200</b>
 <b>12W</b>	BD-12/RG: Màu đỏ sẫm BD-12/SL: Màu bạc BD-12/BR: Màu vàng đồng BD-12/NL: Màu niken BD-12/BL: Màu đen	<b>114.400</b>	 <b>24W</b>	BD-24/RG: Màu đỏ sẫm BD-24/SL: Màu bạc BD-24/BR: Màu vàng đồng BD-24/NL: Màu niken BD-24/BL: Màu đen	<b>205.600</b>



# LED Panel Ốp Trần Cảm Biến Chuyển Động



## Seri SRPL/MS Cảm biến chuyển động

	Mã hàng Model	Quang thông Lumens	Nhiệt độ màu CCT	Kích thước Size	Đóng gói Package	Đơn giá (VNĐ)
 <b>12W</b>	SRPL-12T/MS	950 Lm	6000 - 6500K	Ø 170x35 mm	1 cái/hộp 30 cái/thùng	<b>688.400</b>
 <b>18W</b>	SRPL-18T/MS	1500 Lm	6000 - 6500K	Ø 217x35 mm	1 cái/hộp 20 cái/thùng	<b>839.700</b>
 <b>24W</b>	SRPL-24T/MS	1800 Lm	6000 - 6500K	Ø 300x35 mm	1 cái/hộp 10 cái/thùng	<b>1.016.400</b>

## Seri SSPL/MS Cảm biến chuyển động

	Mã hàng Model	Quang thông Lumens	Nhiệt độ màu CCT	Kích thước Size	Đóng gói Package	Đơn giá (VNĐ)
 <b>12W</b>	SSPL-12T/MS	950 Lm	6000 - 6500K	170x170x35 mm	1 cái/hộp 30 cái/thùng	<b>726.600</b>
 <b>18W</b>	SSPL-18T/MS	1500 Lm	6000 - 6500K	217x217x35 mm	1 cái/hộp 20 cái/thùng	<b>914.200</b>
 <b>24W</b>	SSPL-24T/MS	1800 Lm	6000 - 6500K	300x300x35 mm	1 cái/hộp 10 cái/thùng	<b>1.101.900</b>

## Seri SRPL/DIM Có thể điều chỉnh độ sáng

	Mã hàng Model	Quang thông Lumens	Kích thước Size	Đóng gói Package	Đơn giá (VNĐ)
	SRPL-6T/DIM SRPL-6V/DIM	500 Lm	Ø120x35 mm	1 cái/hộp 40 cái/thùng	<b>517.100</b>
	SRPL-12T/DIM SRPL-12V/DIM	950 Lm	Ø170x35 mm	1 cái/hộp 30 cái/thùng	<b>690.200</b>
	SRPL-18T/DIM SRPL-18V/DIM	1500 Lm	Ø217x35 mm	1 cái/hộp 20 cái/thùng	<b>898.100</b>
	SRPL-24T/DIM SRPL-24V/DIM	1800 Lm	Ø300x35 mm	1 cái/hộp 10 cái/thùng	<b>1.129.000</b>

## Seri SSPL/DIM Có thể điều chỉnh độ sáng

	Mã hàng Model	Quang thông Lumens	Kích thước Size	Đóng gói Package	Đơn giá (VNĐ)
	SSPL-6T/DIM SSPL-6V/DIM	500 Lm	120x120x35 mm	1 cái/hộp 40 cái/thùng	<b>540.600</b>
	SSPL-12T/DIM SSPL-12V/DIM	950 Lm	170x170x35 mm	1 cái/hộp 30 cái/thùng	<b>723.500</b>
	SSPL-18T/DIM SSPL-18V/DIM	1500 Lm	217x217x35 mm	1 cái/hộp 20 cái/thùng	<b>939.700</b>
	SSPL-24T/DIM SSPL-24V/DIM	1800 Lm	300x300x35 mm	1 cái/hộp 10 cái/thùng	<b>1.185.100</b>

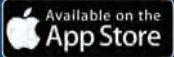

**New**



### ĐẶC ĐIỂM KỸ THUẬT:



- Sản phẩm có mạch tích hợp và độ nhạy cao
- Cảm biến chuyển động hồng ngoại
- Cảm biến sáng tối tự động
- Tiện lợi, an toàn và tiết kiệm năng lượng
- Thiết kế hiện đại, dễ dàng cài đặt và sử dụng
- Điều khiển bằng App MPE Smart Control

	Mã số / Diễn giải	Đơn giá (VNĐ)
	<b>MIR1-NT/DW</b> Cảm biến chuyển động hồng ngoại WIFI - Công suất tiêu thụ: 0.5W - Công suất tải: <200W - Góc quét: 90° - Bán kính làm việc: ≤ 4m (<24°C) - Điện áp: 220-240VAC - Chiều cao lắp đặt: 2.2-4m - IP20	865.600
	<b>MIR1-NT/EW</b> Cảm biến chuyển động hồng ngoại WIFI - Công suất tiêu thụ: 0.5W - Công suất tải: <200W - Góc quét: 90° - Bán kính làm việc: ≤ 4m (<24°C) - Điện áp: 220-240VAC - Chiều cao lắp đặt: 2.2-4m - IP20	967.000

	Mã số / Diễn giải	Đơn giá (VNĐ)
	<b>MIR1-OD/W</b> Cảm biến chuyển động hồng ngoại WIFI - Công suất tiêu thụ: 0.5W - Công suất tải: <200W - Góc quét: 180° - Khoảng cách hoạt động: ≤ 12m (<24°C) - Điện áp: 220-240VAC - Chiều cao lắp đặt: 1.8-2.5m - IP44	883.000
	<b>MIR2-AT/W</b> Cảm biến chuyển động hồng ngoại WIFI - Công suất tiêu thụ: 0.5W - Công suất tải: <200W - Góc quét: 90° - Khoảng cách hoạt động: ≤ 4m (<24°C) - Điện áp: 220-240VAC - Chiều cao lắp đặt: 2.2-4m - IP20	866.600



**Thiết bị cảm biến chuyển động Microwave, hồng ngoại, photocell**

	<b>Mã số / Diễn giải</b>	<b>Đơn giá (VNĐ)</b>		<b>Mã số / Diễn giải</b>	<b>Đơn giá (VNĐ)</b>
	<p><b>MWS1-NT</b>            Cảm biến chuyển động Microwave gắn nổi            Công suất tải: ≤ 200W            Góc quét: 360°            Khoảng cách hoạt động: ≤ 8m (bán kính)            IP20</p>	<p><b>371.800</b></p>		<p><b>IRHD1</b>            Đui đèn cảm biến chuyển động hồng ngoại E27            Công suất tải: ≤ 60W            Góc quét: 360°            Khoảng cách hoạt động: ≤ 6m (bán kính)            Điện áp: 110-240VAC            Có thể điều chỉnh thời gian, độ nhạy sáng            IP20</p>	<p><b>235.400</b></p>
	<p><b>MWS1-AT</b>            Cảm biến chuyển động Microwave gắn âm            Công suất tải: ≤ 200W            Góc quét: 360°            Khoảng cách hoạt động: ≤ 8m (bán kính)            IP20</p>	<p><b>407.000</b></p>		<p><b>IRHD2</b>            Đui đèn cảm biến chuyển động hồng ngoại E27            Công suất tải: ≤ 60W            Góc quét: 120°            Khoảng cách hoạt động: ≤ 6m (bán kính)            IP20</p>	<p><b>249.700</b></p>
	<p><b>MWS2-NT</b>            Cảm biến chuyển động Microwave gắn nổi            Công suất tải: ≤ 200W            Góc quét: 360°            Khoảng cách hoạt động: ≤ 8m (bán kính)            IP20</p>	<p><b>371.800</b></p>		<p><b>IRS1-V</b>            Cảm biến chuyển động Hồng ngoại vuông            Công suất tải: ≤ 200W            Góc quét: 160°            Khoảng cách hoạt động: ≤ 9m (bán kính)            IP20</p>	<p><b>269.500</b></p>
	<p><b>MWHD1</b>            Đui đèn cảm biến Microwave            Công suất tải: ≤ 60W            Góc quét: 360°            Khoảng cách hoạt động: ≤ 5m (bán kính)            IP20</p>	<p><b>455.400</b></p>		<p><b>IRS2-V</b>            Cảm biến chuyển động Hồng ngoại vuông (mặt kính)            Công suất tải: ≤ 200W            Góc quét: 160°            Khoảng cách hoạt động: ≤ 9m (bán kính)            IP20</p>	<p><b>407.000</b></p>
	<p><b>PTC1</b>            Cảm biến quang Photocell            Công suất tải: ≤ 10A            Hoạt động khi ánh sáng: &lt; 5-15 Lux            IP44</p>	<p><b>227.700</b></p>		<p><b>IRS1-H</b>            Cảm biến chuyển động Hồng ngoại chữ nhật            Công suất tải: ≤ 200W            Góc quét: 180°            Khoảng cách hoạt động: ≤ 9m (bán kính)            IP20</p>	<p><b>255.200</b></p>

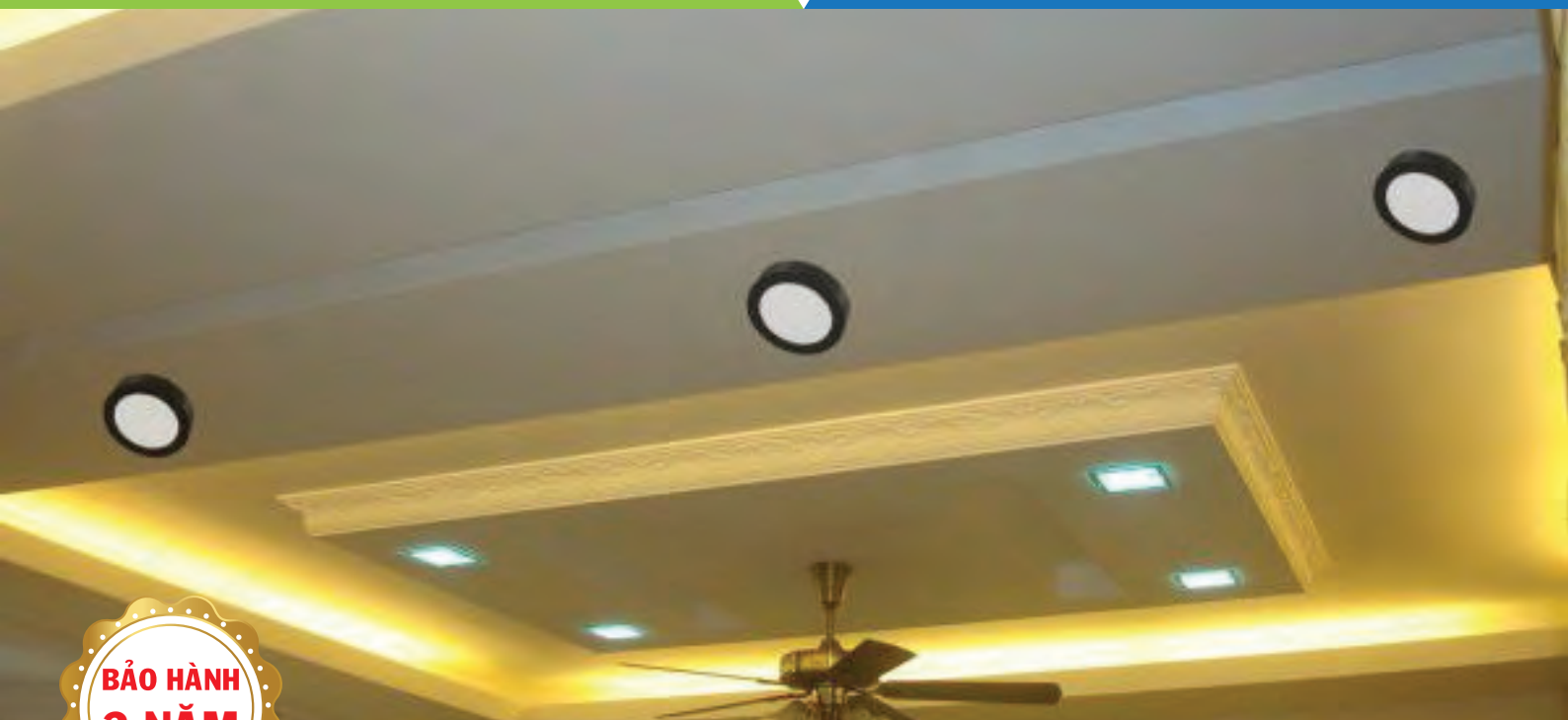
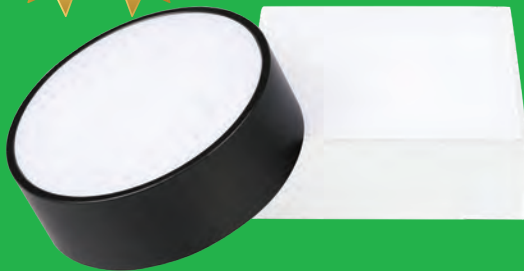
**New****New**

## Đặc tính sản phẩm



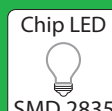

- Sản phẩm đạt tiêu chuẩn Châu Âu
- Thiết kế nhỏ gọn, dễ dàng lắp đặt
- Không hồng ngoại & tia cực tím
- Không nhấp nháy, khởi động tức thì
- Thiết kế hiện đại, sang trọng
- Hiệu suất cao, tiết kiệm điện năng
- Thân thiện môi trường
- Viên đèn siêu mỏng
- Diện tích phát sáng lớn hơn, ánh sáng tràn ra các cạnh của viên

**DIALux****German Technology**



# LED Downlight Ốp Trần Trần Viên



## Seri SRDL (Thân đèn tròn màu trắng)

	Mã hàng Model	Quang thông Lumens	Nhiệt độ màu CCT	Kích thước Size	Đóng gói Package	Đơn giá (VNĐ)
 16W	SRDL-16T SRDL-16N SRDL-16V	1600 Lm	6000 - 6500K 4000 - 4500K 2800 - 3200K	Ø120x40mm	1 cái/hộp 40 cái/thùng	394.900
	SRDL-16/3C		6500-3000-4000K			568.700
 24W	SRDL-24T SRDL-24N SRDL-24V	2400 Lm	6000 - 6500K 4000 - 4500K 2800 - 3200K	Ø175x40mm	1 cái/hộp 20 cái/thùng	547.800
	SRDL-24/3C		6500-3000-4000K			759.000
 32W	SRDL-32T SRDL-32N SRDL-32V	3200 Lm	6000 - 6500K 4000 - 4500K 2800 - 3200K	Ø225x40mm	1 cái/hộp 10 cái/thùng	775.500
	SRDL-32/3C		6500-3000-4000K			1.149.500
 48W	SRDL-48T SRDL-48N SRDL-48V	4800 Lm	6000 - 6500K 4000 - 4500K 2800 - 3200K	Ø300x40mm	1 cái/hộp 8 cái/thùng	1.427.800
	SRDL-48/3C		6500-3000-4000K			2.152.700

## Seri SSDL (Thân đèn vuông màu trắng)

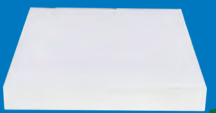
	Mã hàng Model	Quang thông Lumens	Nhiệt độ màu CCT	Kích thước Size	Đóng gói Package	Đơn giá (VNĐ)
 16W	SSDL-16T SSDL-16N SSDL-16V	1600 Lm	6000 - 6500K 4000 - 4500K 2800 - 3200K	120x120x40mm	1 cái/hộp 40 cái/thùng	410.300
	SSDL-16/3C		6500-3000-4000K			588.500
 24W	SSDL-24T SSDL-24N SSDL-24V	2400 Lm	6000 - 6500K 4000 - 4500K 2800 - 3200K	175x175x40mm	1 cái/hộp 20 cái/thùng	569.800
	SSDL-24/3C		6500-3000-4000K			797.500
 32W	SSDL-32T SSDL-32N SSDL-32V	3200 Lm	6000 - 6500K 4000 - 4500K 2800 - 3200K	225x225x40mm	1 cái/hộp 10 cái/thùng	814.000
	SSDL-32/3C		6500-3000-4000K			1.206.700
 48W	SSDL-48T SSDL-48N SSDL-48V	4800 Lm	6000 - 6500K 4000 - 4500K 2800 - 3200K	300x300x40mm	1 cái/hộp 8 cái/thùng	1.499.300
	SSDL-48/3C		6500-3000-4000K			2.261.600

# LED Downlight Ốp Trần Trần Viên



## Seri SRDLB (Thân đèn tròn màu đen)





	Mã hàng Model	Quang thông Lumens	Nhiệt độ màu CCT	Kích thước Size	Đóng gói Package	Đơn giá (VNĐ)
 16W	SRDLB-16T SRDLB-16N SRDLB-16V	1600 Lm	6000 - 6500K 4000 - 4500K 2800 - 3200K	Ø120x40mm	1 cái/hộp 40 cái/thùng	394.900
	SRDLB-16/3C		6500-3000-4000K			568.700
 24W	SRDLB-24T SRDLB-24N SRDLB-24V	2400 Lm	6000 - 6500K 4000 - 4500K 2800 - 3200K	Ø175x40mm	1 cái/hộp 20 cái/thùng	547.800
	SRDLB-24/3C		6500-3000-4000K			759.000
 32W	SRDLB-32T SRDLB-32N SRDLB-32V	3200 Lm	6000 - 6500K 4000 - 4500K 2800 - 3200K	Ø225x40mm	1 cái/hộp 10 cái/thùng	775.500
	SRDLB-32/3C		6500-3000-4000K			1.149.500
 48W	SRDLB-48T SRDLB-48N SRDLB-48V	4800 Lm	6000 - 6500K 4000 - 4500K 2800 - 3200K	Ø300x40mm	1 cái/hộp 8 cái/thùng	1.427.800
	SRDLB-48/3C		6500-3000-4000K			2.152.700



## Seri SSDLB (Thân đèn vuông màu đen)



	Mã hàng Model	Quang thông Lumens	Nhiệt độ màu CCT	Kích thước Size	Đóng gói Package	Đơn giá (VNĐ)
 16W	SSDLB-16T SSDLB-16N SSDLB-16V	1600 Lm	6000 - 6500K 4000 - 4500K 2800 - 3200K	120x120x40mm	1 cái/hộp 40 cái/thùng	410.300
	SSDLB-16/3C		6500-3000-4000K			588.500
 24W	SSDLB-24T SSDLB-24N SSDLB-24V	2400 Lm	6000 - 6500K 4000 - 4500K 2800 - 3200K	175x175x40mm	1 cái/hộp 20 cái/thùng	569.800
	SSDLB-24/3C		6500-3000-4000K			797.500
 32W	SSDLB-32T SSDLB-32N SSDLB-32V	3200 Lm	6000 - 6500K 4000 - 4500K 2800 - 3200K	225x225x40mm	1 cái/hộp 10 cái/thùng	814.000
	SSDLB-32/3C		6500-3000-4000K			1.206.700
 48W	SSDLB-48T SSDLB-48N SSDLB-48V	4800 Lm	6000 - 6500K 4000 - 4500K 2800 - 3200K	300x300x40mm	1 cái/hộp 8 cái/thùng	1.499.300
	SSDLB-48/3C		6500-3000-4000K			2.261.600

# LED Downlight âm trần seri DLE - DLEL



Seri DLE	Mã hàng Model	Quang thông Lumens	Nhiệt độ màu CCT	Kích thước Size	Đục lỗ Cut out	Đóng gói Package	Đơn giá (VNĐ)
 6W	DLEL-6T DLEL-6V	600Lm	6000 - 6500K 2800 - 3200K	Ø102x50mm	Ø90mm	1 cái/hộp 40 cái/thùng	110.900
	DLEL-6/3C		6000-3000-4000K				151.300
 7W	DLE-7T DLE-7V	700Lm	6000 - 6500K 2800 - 3200K	Ø102x50mm	Ø90mm	1 cái/hộp 40 cái/thùng	110.900
	DLE-7/3C		6000-3000-4000K				151.300
 9W	DLEL-9T DLEL-9V	900Lm	6000 - 6500K 2800 - 3200K	Ø122x50mm	Ø100mm	1 cái/hộp 30 cái/thùng	130.500
	DLEL-9/3C		6000-3000-4000K				187.100
 12W	DLE-12T DLE-12V	1200Lm	6000 - 6500K 2800 - 3200K	Ø166x54mm	Ø150mm	1 cái/hộp 20 cái/thùng	189.400
	DLE-12/3C		6000-3000-4000K				283.000
 18W	DLE-18T DLE-18V	1800Lm	6000 - 6500K 2800 - 3200K	Ø216x55mm	Ø200mm	1 cái/hộp 10 cái/thùng	294.500
	DLE-18/3C		6000-3000-4000K				376.500

Khung lắp nổi	Mã hàng Model	Đơn giá (VNĐ)
 6W 7W	<b>SRDLE-6</b> Khung lắp nổi dùng cho DLEL 6W, DLE 7W cao 50mm	37.000
 9W	<b>SRDLE-9</b> Khung lắp nổi dùng cho DLEL 9W cao 50mm	43.900

Khung lắp nổi	Mã hàng Model	Đơn giá (VNĐ)
 12W	<b>SRDLE-12</b> Khung lắp nổi dùng cho DLE 12W cao 55mm	55.400
 18W	<b>SRDLE-18</b> Khung lắp nổi dùng cho DLE 18W cao 55mm	67.000



- Driver tích hợp bên trong thân đèn siêu mỏng, thuận tiện cho việc lắp đặt
- Tấm chống chói và khuếch tán ánh sáng tốt giúp không bị chói mắt
- Đèn được thiết kế sang trọng và chắc chắn có thể lắp nổi hoặc treo
- Đèn có 3 chế độ màu





**DIALux**  
German Technology



Đèn có thể lắp nổi, lắp treo, 3 chế độ màu



### Seri MCL

Mã hàng Model	Quang thông Lumens	Nhiệt độ màu CCT	Kích thước Size	Đóng gói Package	Đơn giá (VNĐ)
<b>10W</b> MCL-10/3C	1200 Lm	6500-3000-4000K	Ø208x24mm	1 cái/hộp 20 cái/thùng	<b>559.900</b>
<b>15W</b> MCL-15/3C	1800 Lm	6500-3000-4000K	Ø293x24mm	1 cái/hộp 10 cái/thùng	<b>816.200</b>
<b>20W</b> MCL-20/3C	2400 Lm	6500-3000-4000K	Ø397x24mm	1 cái/hộp 10 cái/thùng	<b>1.277.100</b>
Mã hàng Model	Công suất Watt	Diễn giải			Đơn giá (VNĐ)
PKTCL-10	10W	Phụ kiện gắn treo cho đèn ốp trần Multi Ceiling Cáp treo dài 0.8m			<b>218.900</b>
PKTCL-15	15W				<b>244.200</b>
PKTCL-20	20W				<b>271.700</b>

LED ốp trần	Mã hàng Model	Quang thông Lumens	Nhiệt độ màu CCT	Kích thước Size	Điện áp Voltage	Đóng gói Package	Đơn giá (VNĐ)
	CL-16T CL-16N CL-16V	1200 Lm	6000 - 6500K 4000 - 4500K 2800 - 3200K	Ø300x85 mm	100 - 240V	1 cái/hộp 5 cái/thùng	<b>380.100</b>
	CL-22T CL-22N CL-22V	1800 Lm	6000 - 6500K 4000 - 4500K 2800 - 3200K	Ø350x85 mm	100 - 240V	1 cái/hộp 5 cái/thùng	<b>557.900</b>

LED ốp trần 3 chế độ	Mã hàng Model	Quang thông Lumens	Nhiệt độ màu CCT	Kích thước Size	Điện áp Voltage	Đóng gói Package	Đơn giá (VNĐ)
	CL-16/3C	1200 Lm	3000-6500-4000K	Ø300x85 mm	100 - 240V	1 cái/hộp 5 cái/thùng	<b>421.600</b>
	CL-22/3C	1800 Lm	3000-6500-4000K	Ø350x85 mm	100 - 240V	1 cái/hộp 5 cái/thùng	<b>635.300</b>



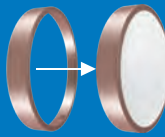
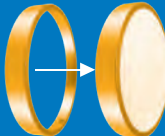

Viên Đèn	Diễn giải	Đơn giá (VNĐ)
	<b>BD30-W</b> Màu trắng (White) 16W	<b>206.800</b>
	<b>BD35-W</b> Màu trắng (White) 22W	<b>244.900</b>
	<b>BD30-S</b> Màu xám bạc (Silver) 16W	<b>206.800</b>
	<b>BD35-S</b> Màu xám bạc (Silver) 22W	<b>244.900</b>
	<b>BD30-C</b> Màu crôm (Chromi) 16W	<b>206.800</b>
	<b>BD35-C</b> Màu crôm (Chromi) 22W	<b>244.900</b>

Viên Đèn	Diễn giải	Đơn giá (VNĐ)
	<b>BD30-R</b> Màu đỏ (Red) 16W	<b>206.800</b>
	<b>BD35-R</b> Màu đỏ (Red) 22W	<b>244.900</b>
	<b>BD30-G</b> Màu vàng (Gold) 16W	<b>206.800</b>
	<b>BD35-G</b> Màu vàng (Gold) 22W	<b>244.900</b>

# LED Ốp Trần Seri RCL, SCL New



## LED ốp trần Seri RCL, SCL

	Mã hàng Model	Quang thông Lumens	Nhiệt độ màu CCT	Kích thước Size	Điện áp Voltage	Đóng gói Package	Đơn giá (VNĐ)
 <b>30W</b>	<b>RCL-30/3C</b>	2400 Lm	4000-6500-3000K	Ø400x65mm	175 - 265V	1 cái/hộp 10 cái/thùng	<b>1.621.300</b>
 <b>40W</b>	<b>RCL-40/3C</b>	3200 Lm	4000-6500-3000K	Ø480x65mm	175 - 265V	1 cái/hộp 5 cái/thùng	<b>2.013.800</b>
 <b>40W</b>	<b>RCLH-40/3C</b>	2800 Lm	4000-6500-3000K	Ø540x75mm	175 - 265V	1 cái/hộp 5 cái/thùng	<b>2.992.700</b>
 <b>40W</b>	<b>SCL-40/3C</b>	2400 Lm	4000-6500-3000K	540x540x80mm	175 - 265V	1 cái/hộp	<b>3.365.600</b>



# LED SPOT LIGHT / LED CHIẾU ĐIỂM

Seri TSL, TSLB	57-58	
Seri TSL2, TSLB2	59-60	
Seri SSL	61-61	
Seri DLA, DLA2	62-63	
Seri DL65	64-64	
Seri SDL	65-65	
Seri DLS	66-66	
Seri LSE, LSR	67-67	
Seri LNC, LNE	68-69	
Seri RLS	70-70	
Seri DPL	71-71	



# LED Chiếu Điểm (Gắn Ray)





## Seri TSL (Thân đèn màu trắng)

	Mã hàng Model	Quang thông Lumens	Nhiệt độ màu CCT	Kích thước Size	Góc chiếu Angle	Đóng gói Package	Đơn giá (VNĐ)
	TSL-8T TSL-8N TSL-8V	800 lm	6000 - 6500K 4000 - 4500K 2800 - 3200K	Ø50X159 mm	36°	1 cái/hộp 40 cái/thùng	<b>500.700</b>
	TSL-12T TSL-12N TSL-12V	1200 lm	6000 - 6500K 4000 - 4500K 2800 - 3200K	Ø50X159 mm	36°	1 cái/hộp 40 cái/thùng	<b>541.900</b>
	TSL-20T TSL-20N TSL-20V	2000 lm	6000 - 6500K 4000 - 4500K 2800 - 3200K	Ø60X173 mm	36°	1 cái/hộp 40 cái/thùng	<b>829.400</b>
	TSL-25T TSL-25N TSL-25V	2500 lm	6000 - 6500K 4000 - 4500K 2800 - 3200K	Ø80X204 mm	36°	1 cái/hộp 5 cái/thùng	<b>1.111.000</b>
	TSL-30T TSL-30N TSL-30V	3200 lm	6000 - 6500K 4000 - 4500K 2800 - 3200K	Ø80X204 mm	36°	1 cái/hộp 5 cái/thùng	<b>1.175.800</b>

## Phụ Kiện

	Mã số / Diễn giải	Đơn giá (VNĐ)
	<b>TR2</b> Thanh Ray 2 dây	<b>164.000</b>
	<b>I</b> Thanh nối I	<b>56.700</b>
	<b>L</b> Thanh nối L	<b>56.700</b>



## Phụ Kiện



	Mã số / Diễn giải	Đơn giá (VNĐ)
	<b>T</b> Thanh nối T	<b>83.200</b>
	<b>X</b> Thanh nối X	<b>97.000</b>

# LED Chiếu Điểm (Gắn Ray)

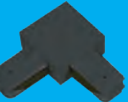

Seri TSLB (Thân đèn màu đen)	Mã hàng Model	Quang thông Lumens	Nhiệt độ màu CCT	Kích thước Size	Góc chiếu Angle	Đóng gói Package	Đơn giá (VNĐ)
 <b>8W</b>	TSLB-8T TSLB-8N TSLB-8V	800 lm	6000 - 6500K 4000 - 4500K 2800 - 3200K	Ø50X159 mm	36°	1 cái/hộp 40 cái/thùng	<b>500.700</b>
 <b>12W</b>	TSLB-12T TSLB-12N TSLB-12V	1200 lm	6000 - 6500K 4000 - 4500K 2800 - 3200K	Ø50X159 mm	36°	1 cái/hộp 40 cái/thùng	<b>541.900</b>
 <b>20W</b>	TSLB-20T TSLB-20N TSLB-20V	2000 lm	6000 - 6500K 4000 - 4500K 2800 - 3200K	Ø60X173 mm	36°	1 cái/hộp 40 cái/thùng	<b>829.400</b>
 <b>25W</b>	TSLB-25T TSLB-25N TSLB-25V	2500 lm	6000 - 6500K 4000 - 4500K 2800 - 3200K	Ø80X204 mm	36°	1 cái/hộp 5 cái/thùng	<b>1.111.000</b>
 <b>30W</b>	TSLB-30T TSLB-30N TSLB-30V	3200 lm	6000 - 6500K 4000 - 4500K 2800 - 3200K	Ø80X204 mm	36°	1 cái/hộp 5 cái/thùng	<b>1.175.800</b>





Phụ Kiện	Mã số / Diễn giải	Đơn giá (VNĐ)
	<b>TR2B</b> Thanh Ray 2 dây	<b>164.000</b>
	<b>IB</b> Thanh nối I	<b>56.700</b>
	<b>LB</b> Thanh nối L	<b>56.700</b>



Phụ Kiện	Mã số / Diễn giải	Đơn giá (VNĐ)
	<b>TB</b> Thanh nối T	<b>83.200</b>
	<b>XB</b> Thanh nối X	<b>97.000</b>



# LED Chiếu Điểm (Gắn Ray)

**New**



Seri TSL2 (Thân đèn màu trắng)	Mã hàng Model	Quang thông Lumens	Nhiệt độ màu CCT	Kích thước WxHxL(mm)	Góc chiếu Angle	Đóng gói Package	Đơn giá (VNĐ)
 <b>8W</b>	TSL2-8T TSL2-8N TSL2-8V	720Lm	6000 - 6500K 4000 - 4500K 2800 - 3200K	Ø50x195mm	36°	1 cái/hộp 10 cái/thùng	<b>410.600</b>
 <b>12W</b>	TSL2-12T TSL2-12N TSL2-12V	1080Lm	6000 - 6500K 4000 - 4500K 2800 - 3200K	Ø65x220mm	36°	1 cái/hộp 10 cái/thùng	<b>487.800</b>
 <b>20W</b>	TSL2-20T TSL2-20N TSL2-20V	1800Lm	6000 - 6500K 4000 - 4500K 2800 - 3200K	Ø75x245mm	36°	1 cái/hộp 8 cái/thùng	<b>663.500</b>
 <b>25W</b>	TSL2-25T TSL2-25N TSL2-25V	2250Lm	6000 - 6500K 4000 - 4500K 2800 - 3200K	Ø75x245mm	36°	1 cái/hộp 8 cái/thùng	<b>722.200</b>
 <b>30W</b> PF>0.9	TSL2-30T TSL2-30N TSL2-30V	2700Lm	6000 - 6500K 4000 - 4500K 2800 - 3200K	Ø75x265mm	36°	1 cái/hộp 8 cái/thùng	<b>823.000</b>

Phụ Kiện	Mã số / Diễn giải	Đơn giá (VNĐ)
	<b>TR2</b> Thanh Ray 2 dây	<b>164.000</b>
	<b>I</b> Thanh nối I	<b>56.700</b>
	<b>L</b> Thanh nối L	<b>56.700</b>



Phụ Kiện	Mã số / Diễn giải	Đơn giá (VNĐ)
	<b>T</b> Thanh nối T	<b>83.200</b>
	<b>X</b> Thanh nối X	<b>97.000</b>



# LED Chiếu Điểm (Gắn Ray)

**New**



Seri TSLB2 (Thân đèn màu đen)	Mã hàng Model	Quang thông Lumens	Nhiệt độ màu CCT	Kích thước WxHxL(mm)	Góc chiếu Angle	Đóng gói Package	Đơn giá (VNĐ)
 <b>8W</b>	TSLB2-8T TSLB2-8N TSLB2-8V	720Lm	6000 - 6500K 4000 - 4500K 2800 - 3200K	Ø50x195mm	36°	1 cái/hộp 10 cái/thùng	<b>410.600</b>
 <b>12W</b>	TSLB2-12T TSLB2-12N TSLB2-12V	1080Lm	6000 - 6500K 4000 - 4500K 2800 - 3200K	Ø65x220mm	36°	1 cái/hộp 10 cái/thùng	<b>487.800</b>
 <b>20W</b>	TSLB2-20T TSLB2-20N TSLB2-20V	1800Lm	6000 - 6500K 4000 - 4500K 2800 - 3200K	Ø75x245mm	36°	1 cái/hộp 8 cái/thùng	<b>663.500</b>
 <b>25W</b>	TSLB2-25T TSLB2-25N TSLB2-25V	2250Lm	6000 - 6500K 4000 - 4500K 2800 - 3200K	Ø75x245mm	36°	1 cái/hộp 8 cái/thùng	<b>722.200</b>
 <b>30W</b> PF>0.9	TSLB2-30T TSLB2-30N TSLB2-30V	2700Lm	6000 - 6500K 4000 - 4500K 2800 - 3200K	Ø75x265mm	36°	1 cái/hộp 8 cái/thùng	<b>823.000</b>

Phụ Kiện	Mã số / Diễn giải	Đơn giá (VNĐ)
	<b>TR2B</b> Thanh Ray 2 dây	<b>164.000</b>
	<b>IB</b> Thanh nối I	<b>56.700</b>
	<b>LB</b> Thanh nối L	<b>56.700</b>

Phụ Kiện	Mã số / Diễn giải	Đơn giá (VNĐ)
	<b>TB</b> Thanh nối T	<b>83.200</b>
	<b>XB</b> Thanh nối X	<b>97.000</b>

# LED Chiếu Điểm (Gắn Nổi)





Seri SSL Gắn Nổi	Mã hàng Model	Quang thông Lumens	Nhiệt độ màu CCT	Kích thước Size	Góc chiếu Angle	Đóng gói Package	Đơn giá (VNĐ)
 <b>7W</b>	SSL-7V	609 lm	3000k	Ø56.2x97x160 mm	24°	1 cái/hộp 40 cái/thùng	<b>479.500</b>
 <b>12W</b>	SSL-12V	1044 lm	3000k	Ø56.2x97x160 mm	24°	1 cái/hộp 40 cái/thùng	<b>550.200</b>
 <b>20W</b>	SSL-20V	1740 lm	3000k	Ø73.2x130x210 mm	36°	1 cái/hộp 20 cái/thùng	<b>1.022.600</b>
 <b>25W</b>	SSL-25V	2175 lm	3000k	Ø73.2x130x210 mm	36°	1 cái/hộp 20 cái/thùng	<b>1.135.700</b>
 <b>30W</b>	SSL-30V	3045 lm	3000k	Ø89.9x140x220 mm	36°	1 cái/hộp 20 cái/thùng	<b>1.500.900</b>



- Đèn có hiệu suất cao 90 Lm/W
- Đèn xoay có thể điều chỉnh hướng sáng theo ý muốn
- 3 chế độ màu : Trắng, vàng, trung tính
- Nhôm đúc nguyên khối cao cấp, tản nhiệt tốt
- LED chip COB cao cấp, tuổi thọ 30.000 giờ







- Mặt đèn lõm giúp tăng chiều sâu cho chùm sáng
- Tiết kiệm điện năng, dễ dàng lắp đặt
- Không gian sang trọng, hài hòa
- Ứng dụng: Công trình nhà ở, Showroom, trung tâm thương mại...

## Seri DLA Gắn âm

	Mã hàng Model	Quang thông Lumens	Nhiệt độ màu CCT	Kích thước Size	Đục lỗ Cut out	Đóng gói Package	Đơn giá (VNĐ)
	DLA-12T DLA-12N DLA-12V	1044 lm	6000K 4000K 3000K	Ø96x75.5mm	Ø85mm	1 cái/hộp 40 cái/thùng	<b>728.100</b>
	DLA-20T DLA-20N DLA-20V	1740 lm	6000K 4000K 3000K	Ø125X100mm	Ø112mm	1 cái/hộp 40 cái/thùng	<b>1.227.600</b>
	DLA-35T DLA-35N DLA-35V	3045 lm	6000K 4000K 3000K	Ø164x131mm	Ø148mm	1 cái/hộp 18 cái/thùng	<b>1.665.900</b>
	DLA-50T DLA-50N DLA-50V	4350 lm	6000K 4000K 3000K	Ø200x170mm	Ø188mm	1 cái/hộp 8 cái/thùng	<b>2.840.500</b>



**Seri DLA2**

	Mã hàng Model	Quang thông Lumens	Nhiệt độ màu CCT	Kích thước Size	Đục lỗ Cut out	Đóng gói Package	Đơn giá (VNĐ)
 Mặt Tròn <b>3W</b>	<b>DLA2R-3T DLA2R-3V</b>	250Lm	6000 - 6500K 2800 - 3200K	Ø90x40mm	Ø68mm	1 cái/hộp 40 cái/thùng	<b>104.900</b>
 Mặt Tròn <b>5W</b>	<b>DLA2R-5T DLA2R-5V</b>	450Lm	6000 - 6500K 2800 - 3200K	Ø90x40mm	Ø68mm	1 cái/hộp 40 cái/thùng	<b>108.100</b>
 Mặt Tròn <b>7W</b>	<b>DLA2R-7T DLA2R-7V</b>	630Lm	6000 - 6500K 2800 - 3200K	Ø90x40mm	Ø68mm	1 cái/hộp 40 cái/thùng	<b>112.400</b>
 Mặt vuông <b>3W</b>	<b>DLA2S-3T DLA2S-3V</b>	250Lm	6000 - 6500K 2800 - 3200K	Ø90x40mm	Ø68mm	1 cái/hộp 40 cái/thùng	<b>104.900</b>
 Mặt vuông <b>5W</b>	<b>DLA2S-5T DLA2S-5V</b>	450Lm	6000 - 6500K 2800 - 3200K	Ø90x40mm	Ø68mm	1 cái/hộp 40 cái/thùng	<b>108.100</b>
 Mặt vuông <b>7W</b>	<b>DLA2S-7T DLA2S-7V</b>	630Lm	6000 - 6500K 2800 - 3200K	Ø90x40mm	Ø68mm	1 cái/hộp 40 cái/thùng	<b>112.400</b>







# LED Downlight Âm Trần Chống Ẩm IP65



- Đèn có hiệu suất cao 90 Lm/W
- Thân đèn làm nhôm cao cấp, phủ sơn tĩnh điện
- Thân đèn với khe tản nhiệt giúp tăng tuổi thọ đèn
- Đèn thiết kế tiêu chuẩn IP65 giúp chống nước, bụi bẩn



- Mặt đèn lõm giúp tăng chiều sâu cho chùm sáng
- Tiết kiệm điện năng, dễ dàng lắp đặt
- Không gian sang trọng, hài hòa
- Ứng dụng: Công trình nhà ở, Showroom, trung tâm thương mại...

## Seri DL65

	Mã hàng Model	Quang thông Lumens	Nhiệt độ màu CCT	Kích thước Size	Đục lỗ Cut out	Đóng gói Package	Đơn giá (VNĐ)
 IP65 12W	DL65-12V	1080 lm	3000k	Ø95x98mm	Ø85mm	1 cái/hộp 48 cái/thùng	1.054.600
 IP65 20W	DL65-20V	1800 lm	3000k	Ø125x120mm	Ø115mm	1 cái/hộp 27 cái/thùng	1.582.400
 IP65 30W	DL65-30V	2700 lm	3000k	Ø150x132mm	Ø140mm	1 cái/hộp 18 cái/thùng	2.042.000

# LED Chiếu Điểm (Gắn Nổi)



Seri SDL Gắn Nổi	Mã hàng Model	Quang thông Lumens	Nhiệt độ màu CCT	Kích thước Size	Góc chiếu Angle	Đóng gói Package	Đơn giá (VNĐ)
 <b>12W</b>	SDL-12T SDL-12V	1044 lm	6000k 3000k	Ø80.6x100mm	24°	1 cái/hộp 40 cái/thùng	<b>653.900</b>
 <b>18W</b>	SDL-18T SDL-18V	2000 lm	6000k 3000k	Ø105x135mm	24°	1 cái/hộp 12 cái/thùng	<b>1.115.700</b>
 <b>24W</b>	SDL-25T SDL-25V	2600 lm	6000k 3000k	Ø145.8x170mm	24°	1 cái/hộp 18 cái/thùng	<b>1.323.000</b>

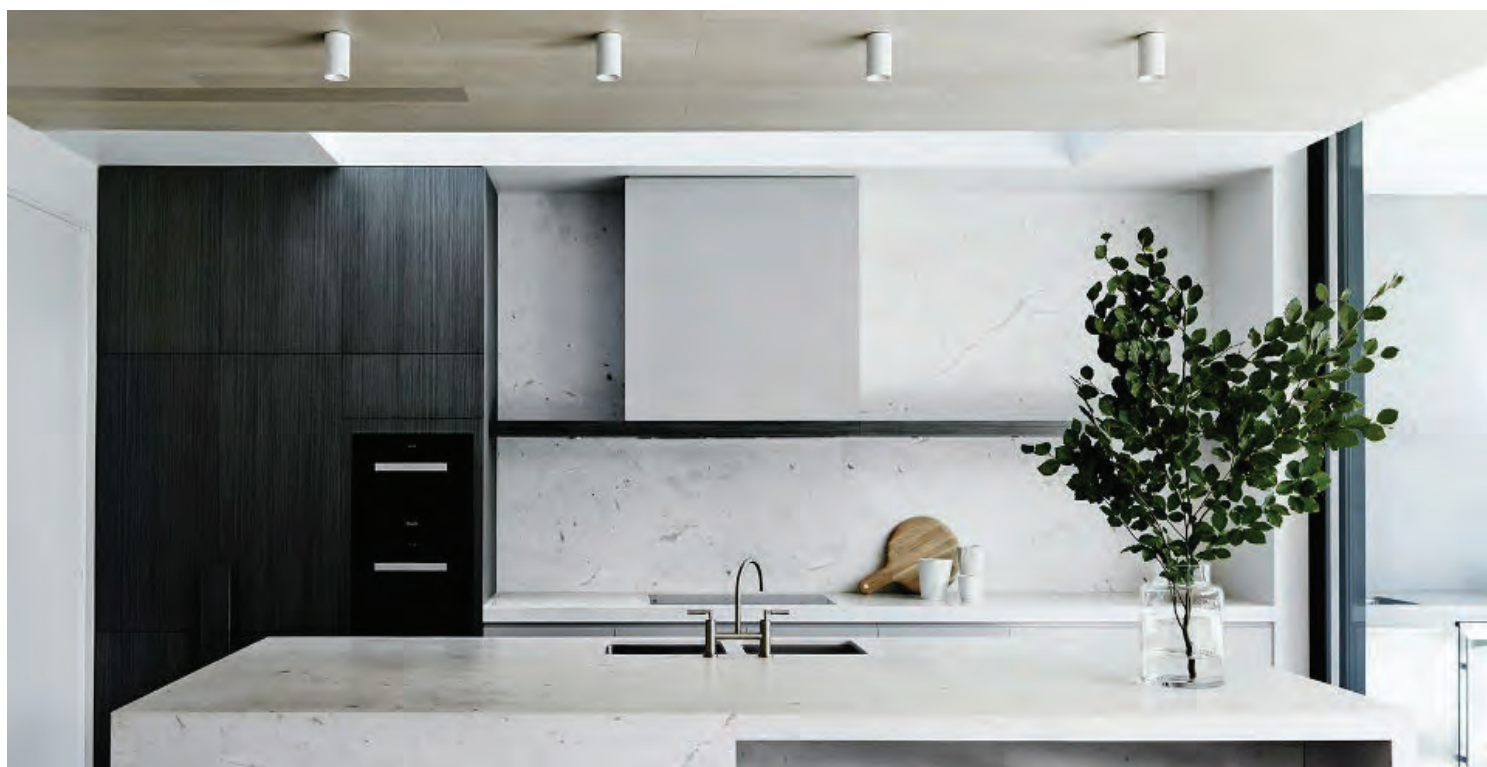

# LED Downlight Âm Trần

**New**



Seri DLS	Mã hàng Model	Quang thông Lumens	Nhiệt độ màu CCT	Kích thước Size	Đục lỗ Cut out	Đóng gói Package	Đơn giá (VNĐ)
 <b>7W</b>	DLS-107T DLS-107N DLS-107V	595Lm	6500k 4000k 3000k	122x122x115 mm	100x100mm	1 cái/hộp 18 cái/thùng	<b>839.800</b>
 <b>7Wx2</b>	DLS-207T DLS-207N DLS-207V	595x2Lm	6500k 4000k 3000k	122x220x115 mm	100x200mm	1 cái/hộp 12 cái/thùng	<b>1.347.500</b>
 <b>12W</b>	DLS-112T DLS-112N DLS-112V	1020Lm	6500k 4000k 3000k	140x140x130 mm	120x120mm	1 cái/hộp 18 cái/thùng	<b>966.500</b>
 <b>12Wx2</b>	DLS-212T DLS-212N DLS-212V	1020x2Lm	6500k 4000k 3000k	140x270x130 mm	120x250mm	1 cái/hộp 6 cái/thùng	<b>1.722.700</b>
 <b>12Wx3</b>	DLS-312T DLS-312N DLS-312V	1020x3Lm	6500k 4000k 3000k	140x390x130 mm	120x370mm	1 cái/hộp 4 cái/thùng	<b>2.662.100</b>
 <b>20W</b>	DLS-120T DLS-120N DLS-120V	1650Lm	6500k 4000k 3000k	140x140x130 mm	120x120mm	1 cái/hộp 12 cái/thùng	<b>1.354.900</b>
 <b>20Wx2</b>	DLS-220T DLS-220N DLS-220V	1650x2Lm	6500k 4000k 3000k	140x270x130 mm	120x250mm	1 cái/hộp 9 cái/thùng	<b>2.697.900</b>
 <b>20Wx3</b>	DLS-320T DLS-320N DLS-320V	1650x3Lm	6500k 4000k 3000k	140x390x130 mm	120x370mm	1 cái/hộp 9 cái/thùng	<b>4.022.100</b>



### ĐẶC ĐIỂM KỸ THUẬT:

- Hiệu suất chiếu sáng cao, ánh sáng trung thực
- Công suất chiếu sáng: 40W
- Ánh sáng: Trắng, vàng, trung tính
- Đèn được thiết kế 2 màu trắng, đen
- Thấu kính truyền sáng cao giúp phân bổ ánh sáng đồng đều
- Lắp đặt nhanh, tiết kiệm chi phí
- Tiết kiệm điện năng, thân thiện môi trường





**New**

### ỨNG DỤNG:

- Chiếu sáng văn phòng, Showroom, nhà ở, căn hộ, siêu thị, bệnh viện, trung tâm thương mại...

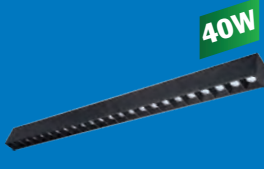

**DIALux**  
German Technology

LED Thanh Gắn Treo	Mã hàng Model	Quang thông Lumens	Nhiệt độ màu CCT	Kích thước Size	Góc chiếu Angle	Đóng gói Package	Đơn giá (VNĐ)
	LSEW-40T LSEW-40N LSEW-40V	3200 lm	6000K 4000K 3000K	1200X43.3X66 mm	15°	1 cái/hộp 40 cái/thùng	<b>3.161.400</b>
	LSEB-40T LSEB-40N LSEB-40V	3200 lm	6000K 4000K 3000K	1200X43.3X66 mm	15°	1 cái/hộp 40 cái/thùng	<b>3.161.400</b>
	LSRW-40T LSRW-40N LSRW-40V	1800 lm	6000K 4000K 3000K	1200X43.3X66 mm	120°	1 cái/hộp 40 cái/thùng	<b>1.563.100</b>
	LSRB-40T LSRB-40N LSRB-40V	1800 lm	6000K 4000K 3000K	1200X43.3X66 mm	120°	1 cái/hộp 40 cái/thùng	<b>1.563.100</b>

**New**

# LED Thanh / Linear



## LED Thanh Điểm Nối Có Đèn seri LNC

	Mã hàng Model	Quang thông Lumens	Nhiệt độ màu CCT	Kích thước Size (LxWxH) mm	Góc chiếu Angle	Đóng gói Package	Đơn giá (VNĐ)
	<b>19W</b> LNCW-19T LNCW-19N	1900Lm	6500K 4000K	600x49x58 mm	110°	1 cái/hộp 6 cái/thùng	<b>2.379.500</b>
	<b>38W</b> LNCW-38T LNCW-38N	4180Lm	6500K 4000K	1200x49x58 mm	110°	1 cái/hộp 6 cái/thùng	<b>2.875.400</b>
	<b>19W</b> LNCB-19T LNCB-19N	1900Lm	6500K 4000K	600x49x58 mm	110°	1 cái/hộp 6 cái/thùng	<b>2.379.500</b>
	<b>38W</b> LNCB-38T LNCB-38N	4180Lm	6500K 4000K	1200x49x58 mm	110°	1 cái/hộp 6 cái/thùng	<b>2.875.400</b>

## Phụ Kiện có đèn dùng cho seri LNC

	Mã hàng Model	Quang thông Lumens	Nhiệt độ màu CCT	Kích thước Size (mm)	Diễn giải	Đóng gói Package	Đơn giá (VNĐ)
	<b>16W</b> LXW-16T LXW-16N	1600Lm	6500K 4000K	252x252x49x58 mm	Thanh nối X thân màu trắng	1 cái/hộp 16 cái/thùng	<b>2.319.900</b>
	<b>12W</b> LTW-12T LTW-12N	1200Lm	6500K 4000K	252x151x49x58 mm	Thanh nối T thân màu trắng	1 cái/hộp 16 cái/thùng	<b>1.753.300</b>
	<b>8W</b> LLW-8T LLW-8N	800Lm	6500K 4000K	151x151x49x58 mm	Thanh nối L thân màu trắng	1 cái/hộp 16 cái/thùng	<b>1.304.900</b>
	<b>16W</b> LXB-16T LXB-16N	1600Lm	6500K 4000K	252x252x49x58 mm	Thanh nối X thân màu đen	1 cái/hộp 16 cái/thùng	<b>2.319.900</b>
	<b>12W</b> LTB-12T LTB-12N	1200Lm	6500K 4000K	252x151x49x58 mm	Thanh nối T thân màu đen	1 cái/hộp 16 cái/thùng	<b>1.753.300</b>
	<b>8W</b> LLB-8T LLB-8N	800Lm	6500K 4000K	151x151x49x58 mm	Thanh nối L thân màu đen	1 cái/hộp 16 cái/thùng	<b>1.304.900</b>

## Phụ Kiện dùng cho seri LNC



	Mã số / Diễn giải	Đơn giá (VNĐ)
	<b>LH</b> Phụ kiện treo	<b>279.800</b>
	<b>LA</b> Phụ kiện âm	<b>196.600</b>

## Phụ Kiện dùng cho seri LNC



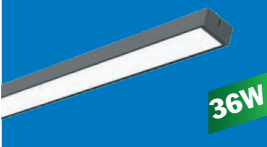

	Mã số / Diễn giải	Đơn giá (VNĐ)
	<b>LS</b> Phụ kiện nối	<b>103.200</b>





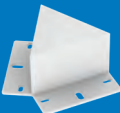
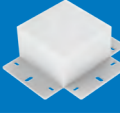
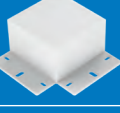

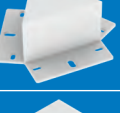
## LED Thanh Loại Tiết Kiệm Seri LNE

	Mã hàng Model	Quang thông Lumens	Nhiệt độ màu CCT	Kích thước Size (LxWxH)	Góc chiếu Angle	Đóng gói Package	Đơn giá (VNĐ)
	<b>LNEB-36T</b> <b>LNEB-36N</b>	3420Lm	6500K 4000K	1200x70x40 mm	110°	1 cái/hộp 10 cái/thùng	<b>1.734.300</b>
	<b>LNEW-36T</b> <b>LNEW-36N</b>	3420Lm	6500K 4000K	1200x70x40 mm	110°	1 cái/hộp 10 cái/thùng	<b>1.734.300</b>

## Phụ Kiện dùng cho seri LNE

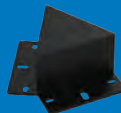
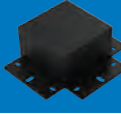
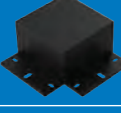
	Mã số / Diễn giải	Đơn giá (VNĐ)
	<b>LEW-V</b> - Thanh nối V - Màu trắng	<b>73.200</b>
	<b>LEW-T</b> - Thanh nối T - Màu trắng	<b>73.200</b>
	<b>LEW-L</b> - Thanh nối L - Màu trắng	<b>73.200</b>
	<b>LEW-H</b> - Thanh nối H - Màu trắng	<b>73.200</b>
	<b>LEW-Y</b> - Thanh nối Y - Màu trắng	<b>73.200</b>
	<b>LEW-X</b> - Thanh nối X - Màu trắng	<b>73.200</b>

## Phụ Kiện dùng cho seri LNE

	Mã số / Diễn giải	Đơn giá (VNĐ)
	<b>LEB-V</b> - Thanh nối V - Màu đen	<b>73.200</b>
	<b>LEB-T</b> - Thanh nối T - Màu đen	<b>73.200</b>
	<b>LEB-L</b> - Thanh nối L - Màu đen	<b>73.200</b>
	<b>LEB-H</b> - Thanh nối H - Màu đen	<b>73.200</b>
	<b>LEB-Y</b> - Thanh nối Y - Màu đen	<b>73.200</b>
	<b>LEB-X</b> - Thanh nối X - Màu đen	<b>73.200</b>



# Đèn LED Thanh Chiếu Điểm



Seri RLS	Mã hàng Model	Quang thông Lumens	Nhiệt độ màu CCT	Góc chiếu Angle	Kích thước Size	Kích thước đục lỗ Cut out	Đơn giá (VNĐ)
	RLS-02	300 lm	4000K	10° 36° 48°	74x56x80mm	58x42mm	<b>384.700</b>
	RLS-03	450 lm	4000K	10° 36° 48°	101x56x80mm	85x42mm	<b>443.500</b>
	RLS-05	750 lm	4000K	10° 36° 48°	154x56x80mm	138x42mm	<b>567.200</b>
	RLS-10	1500 lm	4000K	10° 36° 48°	287x56x80mm	271x42mm	<b>1.860.800</b>
	RLS-15	2500 lm	4000K	10° 36° 48°	420x56x80mm	402x42mm	<b>2.389.800</b>
	RLS-10-2C	1300 lm	4000K	10° 36° 48°	1017x56x80mm	1000x48mm	<b>2.646.200</b>
	RLS-12-3C	1950 lm	4000K	10° 36° 48°	1217x56x80mm	1200x48mm	<b>3.224.800</b>
	RLS-15-4C	2600 lm	4000K	10° 36° 48°	1517x56x80mm	1500x48mm	<b>3.868.200</b>
	RLS-10-F	2700 lm	4000K	10° 36° 48°	1017x56x80mm	1000x48mm	<b>3.143.900</b>
	RLS-12-F	3600 lm	4000K	10° 36° 48°	1217x56x80mm	1200x48mm	<b>3.564.300</b>
	RLS-15-F	4500 lm	4000K	10° 36° 48°	1517x56x80mm	1500x48mm	<b>4.636.200</b>

# LED Chiếu Điểm (Dạng Treo)



Seri DPL	Mã hàng Model	Quang thông Lumens	Nhiệt độ màu CCT	Kích thước Size	Góc chiếu Angle	Đóng gói Package	Đơn giá (VNĐ)
	DPL-7V	490 lm	3000k	Ø45x300 mm Dây treo dài 1m	24°	1 cái/hộp 40 cái/thùng	<b>688.400</b>
	DPL-12V	950 lm	3000k	Ø55x300 mm Dây treo dài 1m	24°	1 cái/hộp 40 cái/thùng	<b>851.300</b>
	DPL-20V	1500 lm	3000k	Ø65X300 mm Dây treo dài 1m	24°	1 cái/hộp 20 cái/thùng	<b>1.224.300</b>
	DPL-30V	2400 lm	3000k	Ø75X300 mm Dây treo dài 1m	24°	1 cái/hộp 20 cái/thùng	<b>1.490.000</b>





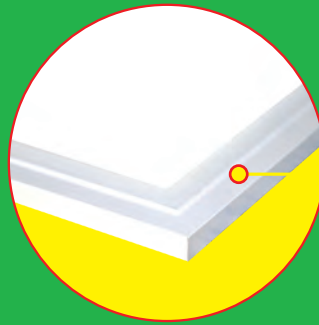

Viền đèn làm bằng hợp kim nhôm sơn tĩnh điện, chống oxy hóa, chống rung, chống ăn mòn, tản nhiệt nhanh.

Sử dụng chip LED cao cấp, có tuổi thọ và hiệu suất ánh sáng cao.



Ánh sáng ổn định, độ bền cao.



Domino kết nối dễ dàng, an toàn với nguồn điện.



Kết nối Driver với đèn dễ dàng an toàn khi sử dụng.

Tấm chống chói mắt (LDP).

Tấm dẫn ánh sáng bằng nhựa PMMA - MITSUBISHI cho ánh sáng phân bố đồng đều.

Tấm cản ánh sáng ngược lại (LRP).

Tấm lót bảo vệ.

Tấm ốp lưng cạnh bo góc ngăn không để ánh sáng phát ra ngoài, độ thẩm mỹ cao.

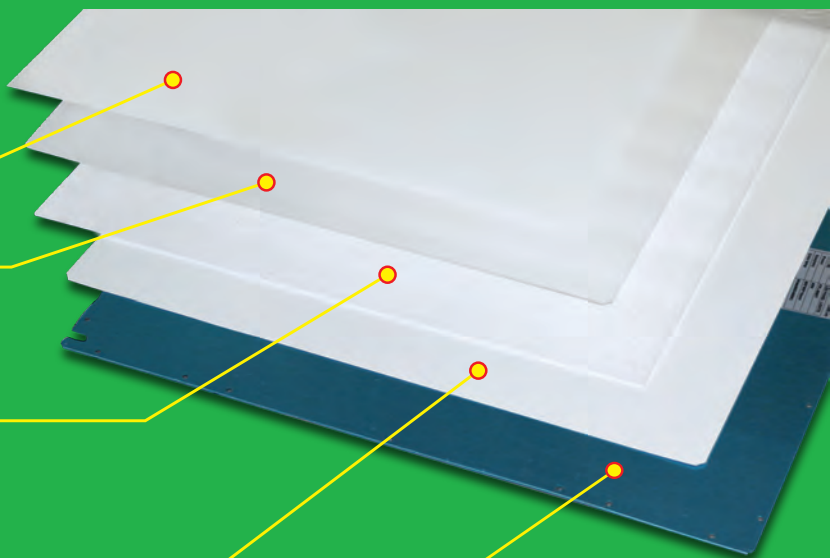



Seri FPL	Mã hàng Model	Quang thông Lumens	Nhiệt độ màu CCT	Kích thước Size	Đóng gói Package	Đơn giá (VND)
 20W	FPL-3030T FPL-3030N FPL-3030V	1800 lm	6000 - 6500k 4000 - 4500k 2800 - 3200k	300x300x10 mm	1 cái/hộp 10 cái/thùng	766.500
 25W	FPL-6030T FPL-6030N FPL-6030V	2250 lm	6000 - 6500k 4000 - 4500k 2800 - 3200k	600x300x10 mm	1 cái/hộp 5 cái/thùng	1.040.700
 40W	FPL-6060T FPL-6060N FPL-6060V	3600 lm	6000 - 6500k 4000 - 4500k 2800 - 3200k	600x600x10 mm	1 cái/hộp 5 cái/thùng	1.354.800
	<b>New</b> FPL-6060/3C		3000-6500-4000K			1.845.800
 40W	FPL-12030T FPL-12030N FPL-12030V	3600 lm	6000 - 6500k 4000 - 4500k 2800 - 3200k	1200x300x10 mm	1 cái/hộp 5 cái/thùng	1.581.600
 60W	FPL-12060T FPL-12060N FPL-12060V	5400 lm	6000 - 6500k 4000 - 4500k 2800 - 3200k	1200x600x10 mm	1 cái/hộp 5 cái/thùng	4.064.200



- Bảo hành 3 năm
- Hiệu suất sáng 100 lm/W
- Ánh sáng trung thực Ra>80
- Giải nhiệt tốt, tuổi thọ cao
- Chất liệu: Khung bộ đèn làm bằng hợp kim nhôm, mặt sau làm bằng kim loại sơn tĩnh điện giúp tản nhiệt nhanh, tăng tuổi thọ của chip LED
- Sử dụng tấm dẫn sáng có hệ số truyền sáng cao, giúp ánh sáng phân bố đồng đều
- Đèn LED sử dụng chip Led có hiệu suất phát quang cao, tiết kiệm điện, chất lượng ánh sáng tốt cho mắt

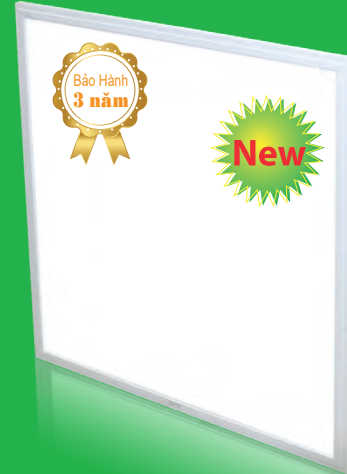

**DIALux**

German Technology

## Seri FPD

	Mã hàng Model	Quang thông Lumens	Nhiệt độ màu CCT	Kích thước Size	Đóng gói Package	Đơn giá (VND)
 <b>20W</b>	<b>FPD-3030T</b> <b>FPD-3030N</b>	2000 Lm	6000 - 6500k 4000 - 4500k	300x300x35 mm	1 cái/hộp 5 cái/thùng	<b>650.800</b>
 <b>40W</b>	<b>FPD-6060T</b> <b>FPD-6060N</b>	4000 Lm	6000 - 6500k 4000 - 4500k	600x600x35 mm	1 cái/hộp 5 cái/thùng	<b>1.055.200</b>
	<b>FPD-6060/3C</b>		6500-3000-4000K			<b>1.566.900</b>
 <b>40W</b>	<b>FPD-12030T</b> <b>FPD-12030N</b>	4000 Lm	6000 - 6500k 4000 - 4500k	1200x300x35 mm	1 cái/hộp 5 cái/thùng	<b>1.344.700</b>

## Phụ kiện gắn treo dùng cho seri FPD, FPL2 và LCR





	Mã hàng Model	Đơn giá (VND)
	<b>PKD-60</b> 4 dây treo dài 1m	<b>131.100</b>
	<b>PKD-120</b> 6 dây treo dài 1m	<b>195.100</b>

## Phụ kiện kẹp 60x60, 120x30 cho seri FPD, FPL2 và LCR

	Mã hàng Model	Đơn giá (VND)
	<b>CKPD-60</b> 4 cái	<b>64.000</b>
	<b>CKPD-120</b> 6 cái	<b>91.300</b>





## Seri FPL điều chỉnh độ sáng

	Mã hàng Model	Quang thông Lumens	Nhiệt độ màu CCT	Kích thước Size	Đóng gói Package	Đơn giá (VND)
	FPL-3030T/DIM FPL-3030N/DIM FPL-3030V/DIM	1800 lm	6000 - 6500k 4000 - 4500k 2800 - 3200k	300x300x10 mm	1 cái/hộp 10 cái/thùng	1.177.800
	FPL-6030T/DIM FPL-6030N/DIM FPL-6030V/DIM	2250 lm	6000 - 6500k 4000 - 4500k 2800 - 3200k	600x300x10 mm	1 cái/hộp 5 cái/thùng	1.476.100
	FPL-6060T/DIM FPL-6060N/DIM FPL-6060V/DIM	3600 lm	6000 - 6500k 4000 - 4500k 2800 - 3200k	600x600x10 mm	1 cái/hộp 5 cái/thùng	2.119.900
	FPL-12030T/DIM FPL-12030N/DIM FPL-12030V/DIM	3600 lm	6000 - 6500k 4000 - 4500k 2800 - 3200k	1200x300x10 mm	1 cái/hộp 5 cái/thùng	2.307.100

## Seri FPL2

	Mã hàng Model	Quang thông Lumens	Nhiệt độ màu CCT	Kích thước Size	Đóng gói Package	Đơn giá (VND)
	FPL2-6060T FPL2-6060N	4000 Lm	6000 - 6500k 4000 - 4500k	600x600x27 mm	1 cái/hộp 5 cái/thùng	1.278.100
<b>Dày 27mm</b>	FPL2-6060/3C		6500-3000-4000K			1.741.900

### Phụ kiện gắn treo cho seri FPL

	Mã hàng Model	Đơn giá (VND)
	PKL-60 4 dây treo dài 1m	131.100
	PKL-120 6 dây treo dài 1m	195.100

### Phụ kiện kẹp 60x60, 120x30 cho seri FPL

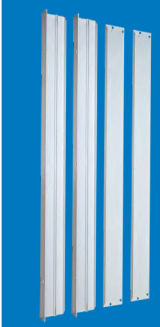

	Mã hàng Model	Đơn giá (VND)
	CKPL-60 4 cái	64.000
	CKPL-120 6 cái	91.300

### Phụ kiện gắn nổi cho seri FPL

	Mã hàng Model	Đơn giá (VND)
	SMPL-3030	302.600
	SMPL-6030	375.400
	SMPL-6060	485.100
	SMPL-12030	519.800



## Seri LCR

	Mã hàng Model	Quang thông Lumens	Nhiệt độ màu CCT	Kích thước Size	Đóng gói Package	Đơn giá (VND)
 <b>RA &gt; 95</b> <b>UGR &lt; 16</b> <b>40W</b>	LCR-6060T	3600 Lm	5500K	600x600x35mm	1 cái/hộp 5 cái/thùng	<b>1.919.700</b>
 <b>RA &gt; 95</b> <b>UGR &lt; 16</b> <b>40W</b>	LCR-12030T	3600 Lm	5500K	1200x300x35mm	1 cái/hộp 5 cái/thùng	<b>2.080.200</b>

- 1 Vỏ ngoài làm bằng nhựa PC, chống cháy, chống chói mắt
- 2 LED chip cao cấp SMD 2835
- 3 Đầu xoay dễ dàng điều chỉnh hướng chiếu, lắp đặt dễ dàng
- 4 Thân làm bằng nhôm chống oxy hóa
- 5 Driver cao cấp độ bền cao

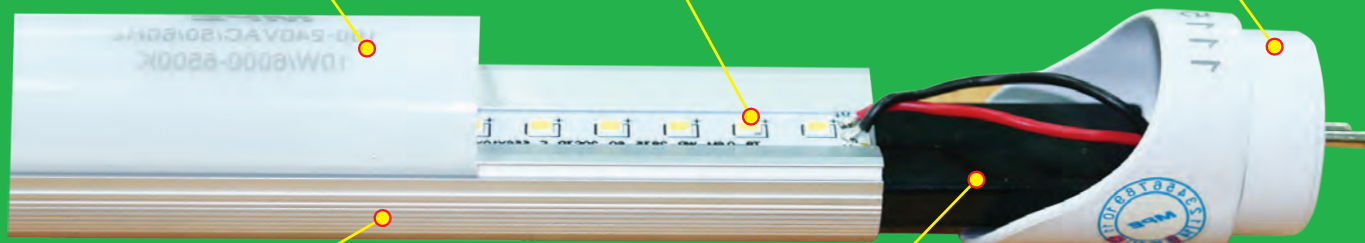

## 1. Cách nối dây tăng phô cơ từ huỳnh quang sang LED

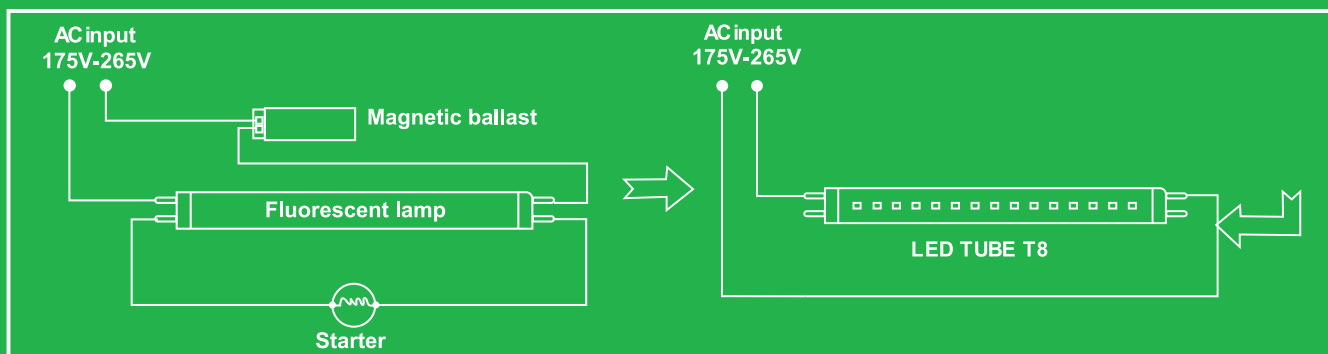

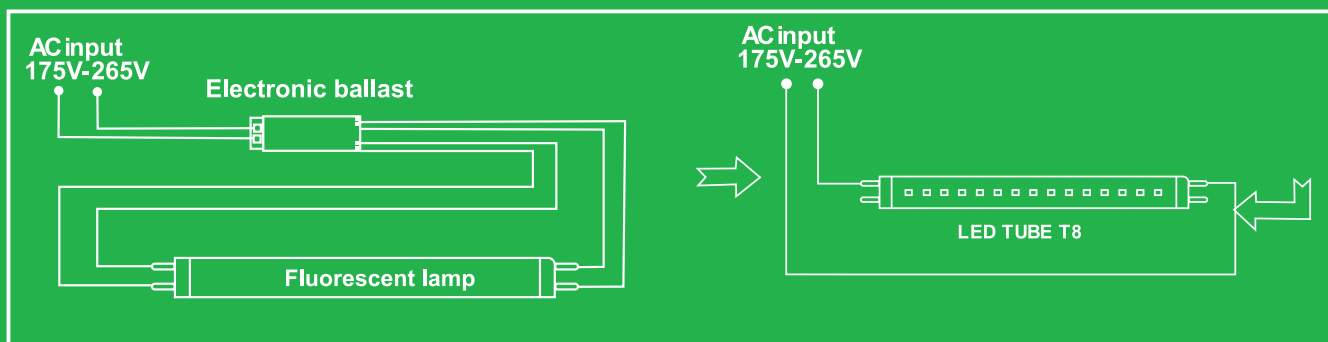

## 1. Cách nối dây tăng điện tử từ huỳnh quang sang LED

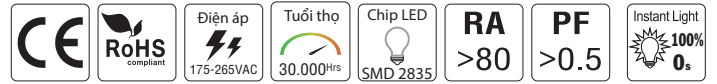

# LED Tube nhôm



LED Tube Nhôm	Mã hàng Model	Quang thông Lumens	Nhiệt độ màu CCT	Góc chiếu Angle	Kích thước Size	Đóng gói Package	Đơn giá (VNĐ)
	<b>LT8-60T</b> <b>LT8-60V</b>	950 lm	6000 - 6500k 2800 - 3200k	160°	A - 588 B - 603 C - Ø26	1 cái/hộp 25 cái/thùng	<b>213.700</b>
	<b>LT8-120T</b> <b>LT8-120V</b>	1850 lm	6000 - 6500k 2800 - 3200k	160°	A - 1197 B - 1213 C - Ø 26	1 cái/hộp 25 cái/thùng	<b>254.100</b>

## Kích thước:

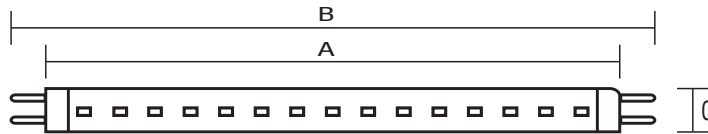

## Máng Batten LED Tube T8

Mã số / Diễn giải	Đơn giá (VNĐ)
<b>EMDK-110</b> Máng Batten LED Tube 1x10W, 0,6m	<b>55.400</b>
<b>EMDK-120</b> Máng Batten LED Tube 1x20W, 1,2m	<b>64.700</b>

## Máng Batten LED Tube T8

Mã số / Diễn giải	Đơn giá (VNĐ)
<b>EMDK-210</b> Máng Batten LED Tube 2x10W, 0,6m	<b>71.600</b>
<b>EMDK-220</b> Máng Batten LED Tube 2x20W, 1,2m	<b>83.200</b>

## Bộ Máng LED Tube Nhôm (bao gồm bóng)

Mã số / Diễn giải	Đơn giá (VNĐ)
<b>MLT-110T</b> Bộ máng Batten LED Tube 1x10W, 0,6m Ánh sáng trắng	<b>269.200</b>
<b>MLT-110V</b> Bộ máng Batten LED Tube 1x10W, 0,6m Ánh sáng vàng	<b>269.200</b>
<b>MLT-210T</b> Bộ máng Batten LED Tube 2x10W, 0,6m Ánh sáng trắng	<b>499.000</b>
<b>MLT-210V</b> Bộ máng Batten LED Tube 2x10W, 0,6m Ánh sáng vàng	<b>499.000</b>

## Bộ Máng LED Tube Nhôm (bao gồm bóng)

Mã số / Diễn giải	Đơn giá (VNĐ)
<b>MLT-120T</b> Bộ máng Batten LED Tube 1x20W, 1,2m Ánh sáng trắng	<b>318.800</b>
<b>MLT-120V</b> Bộ máng Batten LED Tube 1x20W, 1,2m Ánh sáng vàng	<b>318.800</b>
<b>MLT-220T</b> Bộ máng Batten LED Tube 2x20W, 1,2m Ánh sáng trắng	<b>591.400</b>
<b>MLT-220V</b> Bộ máng Batten LED Tube 2x20W, 1,2m Ánh sáng vàng	<b>591.400</b>

# LED Tube Thủy Tinh



LED Tube Thủy Tinh	Mã hàng Model	Quang thông Lumens	Nhiệt độ màu CCT	Góc chiếu Angle	Kích thước Size (mm)	Đóng gói Package	Đơn giá (VNĐ)
	GT-60T GT-60V	1000 lm	6000 - 6500k 2800 - 3200k	330°	600x26mm	1 cái/hộp 25 cái/thùng	<b>82.400</b>
	GT-120T GT-120V	2000 lm	6000 - 6500k 2800 - 3200k	330°	1200x26mm	1 cái/hộp 25 cái/thùng	<b>113.700</b>
	GT8-60T GT8-60V	1200 lm	6000 - 6500k 2800 - 3200k	330°	600x26mm	1 cái/hộp 25 cái/thùng	<b>82.400</b>
	GT8-120T GT8-120V	2400 lm	6000 - 6500k 2800 - 3200k	330°	1200x26mm	1 cái/hộp 25 cái/thùng	<b>113.700</b>

## Bộ Máng LED Tube Thủy tinh (bao gồm bóng)

	Mã hàng Model	Diễn giải	Kích thước	Đóng gói Package	Đơn giá (VNĐ)
	MGT-110T MGT8-110T	Bộ máng Batten LED Tube thủy tinh <b>1x9W 0.6m</b> , ánh sáng trắng	600mm	12 cái/thùng	<b>137.800</b>
	MGT-110V MGT8-110V	Bộ máng Batten LED Tube thủy tinh <b>1x9W 0.6m</b> , ánh sáng vàng			
	MGT-120T MGT8-120T	Bộ máng Batten LED Tube thủy tinh <b>1x18W 1.2m</b> , ánh sáng trắng	1200mm	12 cái/thùng	<b>161.300</b>
	MGT-120V MGT8-120V	Bộ máng Batten LED Tube thủy tinh <b>1x18W 1.2m</b> , ánh sáng vàng			
	MGT-210T MGT8-210T	Bộ máng Batten LED Tube thủy tinh <b>2x9W 0.6m</b> , ánh sáng trắng	600mm	-	<b>236.400</b>
	MGT-210V MGT8-210V	Bộ máng Batten LED Tube thủy tinh <b>2x9W 0.6m</b> , ánh sáng vàng			
	MGT-220T MGT8-220T	Bộ máng Batten LED Tube thủy tinh <b>2x18W 1.2m</b> , ánh sáng trắng	1200mm	-	<b>287.400</b>
	MGT-220V MGT8-220V	Bộ máng Batten LED Tube thủy tinh <b>2x18W 1.2m</b> , ánh sáng vàng			



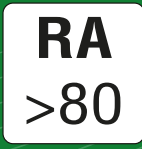

**LED TUBE THỦY TINH GT2**



**LED TUBE THỦY TINH GT3**



**LED TUBE THỦY TINH GT5**







**LED TUBE THỦY TINH GT8**

## Siêu Bền Siêu Sáng - Siêu Tiết Kiệm

**Bảo Hành 5 Năm Đầu Tiên Và Duy Nhất  
Trên Thị Trường**



**DIALux**  
German Technology

LED Tube Thủy Tinh	Mã hàng Model	Quang thông Lumens	Nhiệt độ màu CCT	Góc chiếu Angle	Kích thước Size (mm)	Đóng gói Package	Đơn giá (VNĐ)
	<b>GT8-120T GT8-120V</b>	2400 lm	6000 - 6500k 2800 - 3200k	330°	1200x26mm	1 cái/hộp 25 cái/thùng	<b>113.700</b>
	<b>GT2-120T GT2-120V</b>	2500 lm	6000 - 6500k 2800 - 3200k	330°	1200x26mm	1 cái/hộp 25 cái/thùng	<b>120.000</b>
	<b>GT5-120T GT5-120V</b>	2600 lm	6000 - 6500k 2800 - 3200k	330°	1200x26mm	1 cái/hộp 25 cái/thùng	<b>125.000</b>
	<b>GT3-120T GT3-120V</b>	3000 lm	6000 - 6500k 2800 - 3200k	330°	1200x26mm	1 cái/hộp 25 cái/thùng	<b>130.000</b>

# LED Tube Nhựa Nano

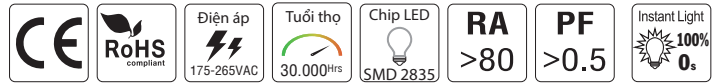

LED Tube Nhựa Nano+PC	Mã hàng Model	Quang thông Lumens	Nhiệt độ màu CCT	Góc chiếu Angle	Kích thước Size (mm)	Đóng gói Package	Đơn giá (VNĐ)
	NT8-60T NT8-60V	950 lm	6000 - 6500k 2800 - 3200k	270°	600 x 26	1 cái/hộp 25 cái/thùng	<b>129.400</b>
	NT8-120T NT8-120V	1850 lm	6000 - 6500k 2800 - 3200k	270°	1200 x 26	1 cái/hộp 25 cái/thùng	<b>164.000</b>

Bộ Máng LED Tube Nhựa Nano+PC (bao gồm bóng)	Mã hàng Model	Diễn giải	Kích thước	Đóng gói Package	Đơn giá (VNĐ)
	MNT-110T	Bộ máng Batten LED Tube Nano 1x9W 0.6m, ánh sáng trắng	600mm	12 cái/thùng	<b>184.800</b>
	MNT-110V	Bộ máng Batten LED Tube Nano 1x9W 0.6m, ánh sáng vàng			
	MNT-120T	Bộ máng Batten LED Tube Nano 1x18W 1.2m, ánh sáng trắng	1200mm	12 cái/thùng	<b>228.700</b>
	MNT-120V	Bộ máng Batten LED Tube Nano 1x18W 1.2m, ánh sáng vàng			
	MNT-210T	Bộ máng Batten LED Tube Nano 2x9W 0.6m, ánh sáng trắng	600mm	-	<b>330.300</b>
	MNT-210V	Bộ máng Batten LED Tube Nano 2x9W 0.6m, ánh sáng vàng			
	MNT-220T	Bộ máng Batten LED Tube Nano 2x18W 1.2m, ánh sáng trắng	1200mm	-	<b>411.200</b>
	MNT-220V	Bộ máng Batten LED Tube Nano 2x18W 1.2m, ánh sáng vàng			

Bộ máng LED Tube Siêu mỏng (bao gồm bóng)	Mã hàng Model	Diễn giải	Kích thước	Đóng gói Package	Đơn giá (VNĐ)
	BT8-60T	Bộ máng Batten LED Tube siêu mỏng 0.6m, ánh sáng trắng	600mm	12 cái/thùng	<b>224.100</b>
	BT8-60V	Bộ máng Batten LED Tube siêu mỏng 0.6m, ánh sáng vàng			
	BT8-120T	Bộ máng Batten LED Tube siêu mỏng 1.2m, ánh sáng trắng	1200mm	12 cái/thùng	<b>290.000</b>
	BT8-120V	Bộ máng Batten LED Tube siêu mỏng 1.2m, ánh sáng vàng			

# LED Tube Diệt Khuẩn, Cảm Biến Chuyển Động, Chống Nổ



## LED Tube diệt khuẩn Có Cảm Biến Chuyển Động



Mã hàng Model	Khoảng cách cảm biến	Không gian khử khuẩn	Bước sóng UVC & UVA	Góc chiếu Angle	Kích thước Size	Đóng gói Package	Đơn giá (VNĐ)
 <b>LT8-60UV</b>	5m	8m <sup>3</sup>	275-400nm	120°	600mm	1 cái/hộp 20 cái/thùng	<b>2.942.500</b>
 <b>LT8-120UV</b>	5m	8m <sup>3</sup>	275-400nm	120°	1200mm	1 cái/hộp 20 cái/thùng	<b>5.494.500</b>

## LED Tube T8 Cảm Biến Chuyển Động

Mã hàng Model	Quang thông Lumens	Nhiệt độ màu CCT	Góc chiếu Angle	Kích thước Size	Đóng gói Package	Đơn giá (VNĐ)
 <b>LT8-60T/MS</b>	950 lm	6000 - 6500k	160°	A - 588 B - 603 C - Ø26	1 cái/hộp 25 cái/thùng	<b>452.800</b>
 <b>LT8-120T/MS</b>	1850 lm	6000 - 6500k	160°	A - 1197 B - 1213 C - Ø26	1 cái/hộp 25 cái/thùng	<b>579.800</b>

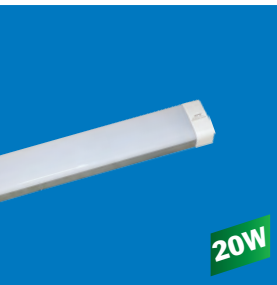
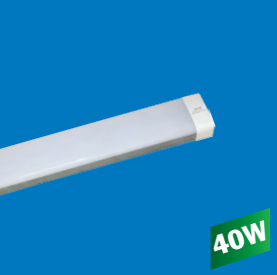
## Bộ LED Chống Nổ

Mã hàng Model	Diễn giải	Kích thước	Đóng gói Package	Đơn giá (VNĐ)
 <b>LE-60T</b>	Bộ LED chống nổ 20W ánh sáng trắng	600mm	-	<b>3.444.200</b>
<b>LE-60V</b>	Bộ LED chống nổ 20W ánh sáng vàng			
 <b>LE-120T</b>	Bộ LED chống nổ 40W ánh sáng trắng	1200mm	-	<b>5.259.900</b>
<b>LE-120V</b>	Bộ LED chống nổ 40W ánh sáng vàng			

LED Bán Nguyệt Seri BN		Mã hàng Model	Quang thông Lumens	Nhiệt độ màu CCT	Góc chiếu Angle	Kích thước Size	Đóng gói Package	Đơn giá (VNĐ)
	9W	BN-9T BN-9N BN-9V	900Lm	6000 - 6500K 4000 - 4500K 2800 - 3200K	120°	300x74x24 mm	1 cái/hộp 12 cái/thùng	258.500
		BN-9/3C (3CCT)		3000-4000-6000K				310.200
		BN-9T/MS (Motion Sensor)		6000 - 6500K				456.500
	18W	BN-18T BN-18N BN-18V	1800Lm	6000 - 6500K 4000 - 4500K 2800 - 3200K	120°	600x74x24 mm	1 cái/hộp 1 pc/box	311.900
		BN-18/3C (3CCT)		3000-4000-6000K				374.000
		BN-18T/MS (Motion Sensor)		6000 - 6500K				511.500
	36W	BN-36T BN-36N BN-36V	3600Lm	6000 - 6500K 4000 - 4500K 2800 - 3200K	120°	1200x74x24 mm	1 cái/hộp 1 pc/box	508.200
		BN-36/3C (3CCT)		3000-4000-6000K				627.000
		BN-36T/MS (Motion Sensor)		6000 - 6500K				764.500

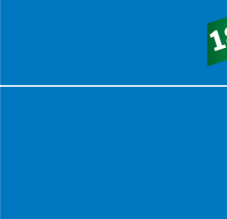
LED Bán Nguyệt Seri BN2		Mã hàng Model	Quang thông Lumens	Nhiệt độ màu CCT	Góc chiếu Angle	Kích thước Size	Đóng gói Package	Đơn giá (VNĐ)
	18W	BN2-18T BN2-18V	1800Lm	6000 - 6500K 2800 - 3200K	120°	600x74x27 mm	1 cái/hộp 12 cái/thùng	218.900
	36W	BN2-36T BN2-36V	3600Lm	6000 - 6500K 2800 - 3200K	120°	1200x74x27 mm	1 cái/hộp 12 cái/thùng	328.900

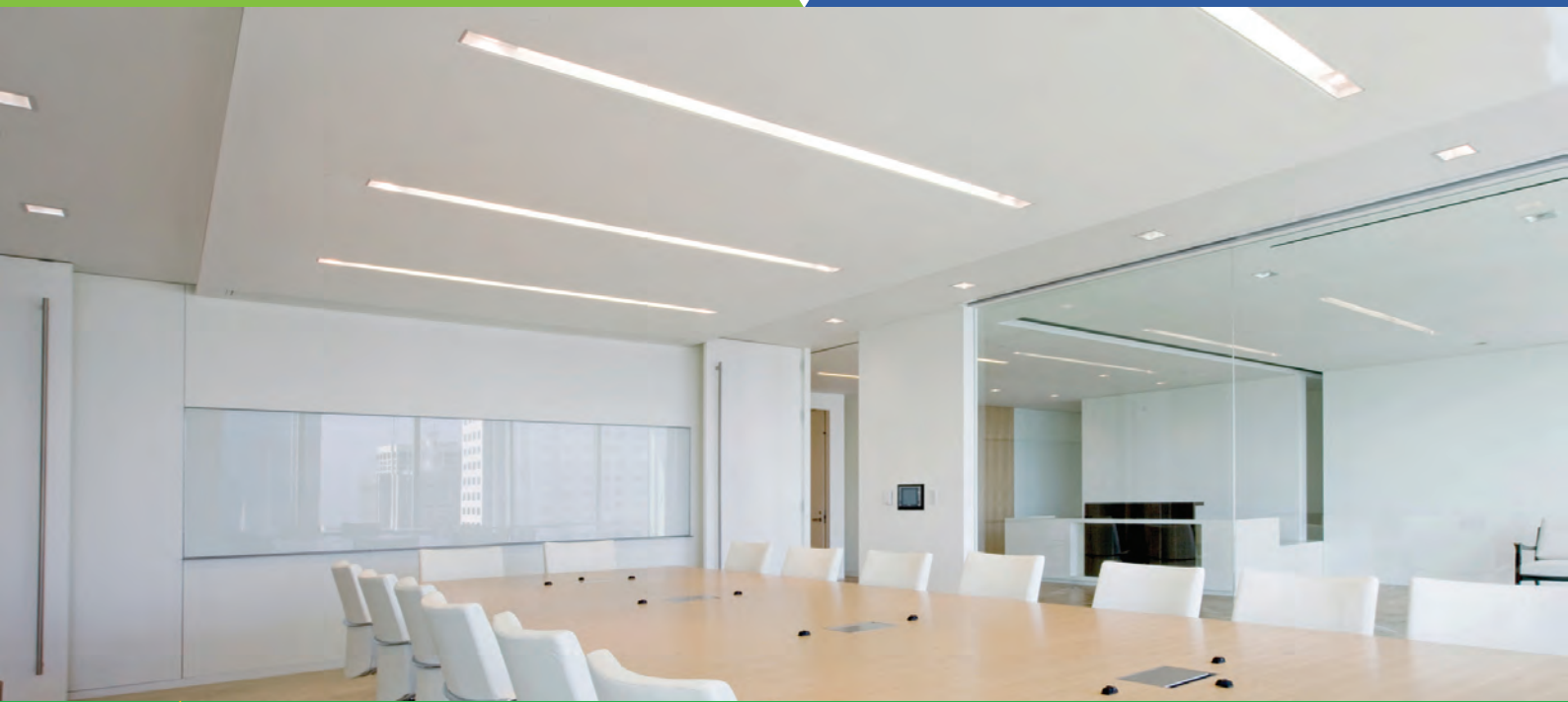

**New**

**DIALux**

German Technology



**Siêu Bền  
Siêu Sáng  
Siêu Tiết Kiệm**

### ĐẶC ĐIỂM KỸ THUẬT:

- Thiết kế sang trọng, tính thẩm mỹ rất cao, thanh mảnh, hình dáng bán nguyệt, phù hợp cho nhiều không gian
- Thân đèn bằng nhôm
- Tiết kiệm điện năng và chi phí đầu tư
- Tuổi thọ cao (30.000 giờ)
- Phát sáng tốt, màu sắc trung thực

### ỨNG DỤNG:

- Chiếu sáng tòa nhà, bệnh viện, trường học, trung tâm thương mại, tầng hầm,...



### Seri BN3

	Mã hàng Model	Quang thông Lumens	Nhiệt độ màu CCT	Kích thước Size (mm)	Góc chiếu Angle	Đóng gói Package	Đơn giá (VNĐ)
	<b>BN3-18T BN3-18V</b>	2000Lm	6000 - 6500K 2800 - 3200K	600x75x30mm	120°	1 cái/hộp 12 cái/thùng	<b>234.600</b>
	<b>BN3-36T BN3-36V</b>	4000Lm	6000 - 6500K 2800 - 3200K	1200x75x30mm	120°	1 cái/hộp 12 cái/thùng	<b>325.900</b>



**New**



### ĐẶC ĐIỂM KỸ THUẬT:

- Thân đèn kín, chống ẩm tối ưu
- Cấp bảo vệ IP65 chống nước
- Bền, nhẹ, dễ dàng lắp đặt
- Tiết kiệm năng lượng
- Sử dụng đèn LED thay thế đèn truyền thống



### ỨNG DỤNG:

- Chiếu sáng tòa nhà, bệnh viện, trường học, trung tâm thương mại, tầng hầm,...

**DIALux**  
German Technology





### Seri LWP2

	Mã hàng Model	Quang thông Lumens	Nhiệt độ màu CCT	Kích thước Size (mm)	PF	Đóng gói Package	Đơn giá (VNĐ)
 <b>IP65</b> <b>20W</b>	LWP2-20T LWP2-20V	2000Lm	6000 - 6500K 2800 - 3200K	637x78x59mm	0.5	1 cái/hộp 12 cái/thùng	<b>678.500</b>
 <b>IP65</b> <b>40W</b>	LWP2-40T LWP2-40V	4000Lm	6000 - 6500K 2800 - 3200K	1237x78x59mm	0.9	1 cái/hộp 12 cái/thùng	<b>1.059.300</b>

# Bộ Máng Xương Cá Âm Trần



## Bộ Máng Xương Cá (bao gồm bóng Tube Thủy Tinh)

	Mã hàng Model	Diễn giải	Kích thước WxLxH	Đóng gói Package	Đơn giá (VNĐ)
	MATL-210T	Bộ máng xương cá LED tube 2 bóng 0.6m ánh sáng trắng (6000-6500K)	605x300x83mm	2 cái/thùng	701.700
	MATL-210V	Bộ máng xương cá LED tube 2 bóng 0.6m ánh sáng vàng (2800-3200K)			
	MATL-220T	Bộ máng xương cá LED tube 2 bóng 1.2m ánh sáng trắng (6000-6500K)	1215x300x83mm		1.131.700
	MATL-220V	Bộ máng xương cá LED tube 2 bóng 1.2m ánh sáng vàng (2800-3200K)			
	MATL-310T	Bộ máng xương cá LED tube 3 bóng 0.6m ánh sáng trắng (6000-6500K)	605x600x83mm	2 cái/thùng	1.113.300
	MATL-310V	Bộ máng xương cá LED tube 3 bóng 0.6m ánh sáng vàng (2800-3200K)			
	MATL-320T	Bộ máng xương cá LED tube 3 bóng 1.2m ánh sáng trắng (6000-6500K)	1215x605x83mm		1.773.200
	MATL-320V	Bộ máng xương cá LED tube 3 bóng 1.2m ánh sáng vàng (2800-3200K)			

Thân đèn bằng kim loại, sơn. Điện năng: 220V-50/60Hz. Công suất tối đa: 100W

## Đèn Lon

	Mã số / Diễn giải	Đơn giá (VNĐ)
	<b>DL - 3</b> (Ø 3.0) Đèn Downlight âm trần phi 80 Downlight D80	86.700
	<b>DL - 3.5</b> (Ø 3.5) Đèn Downlight âm trần phi 90 Downlight D90	104.000
	<b>DL - 4</b> (Ø 4.0) Đèn Downlight âm trần phi 115 Downlight D115	138.600

# LED Pha seri FLD



Seri FLD	Mã hàng Model	Quang thông Lumens	Nhiệt độ màu CCT	Kích thước Size (WxHxL)	Đóng gói Package	Đơn giá (VND)
	FLD-10RGB	-	RGB	115x135x40mm	1 cái/hộp 20 cái/thùng	<b>563.600</b>
	FLD-20RGB	-	RGB	115x200x50mm	1 cái/hộp 20 cái/thùng	<b>939.100</b>
	FLD-10T FLD-10V	800Lm	6000-6500k 2800-3200k	137x97x26mm	1 cái/hộp 20 cái/thùng	<b>369.900</b>
	FLD-20T FLD-20V	1600Lm	6000-6500k 2800-3200k	205x145x36mm	1 cái/hộp 20 cái/thùng	<b>581.900</b>
	FLD-30T FLD-30V	2400Lm	6000-6500k 2800-3200k	205x145x36mm	1 cái/hộp 10 cái/thùng	<b>768.900</b>
	FLD-50T FLD-50V	4000Lm	6000-6500k 2800-3200k	274x194x48mm	1 cái/hộp 10 cái/thùng	<b>1.098.900</b>
	FLD-80T FLD-80V	6400Lm	6000-6500k 2800-3200k	301x246x100mm	4 cái/thùng	<b>2.475.000</b>
	FLD-100T FLD-100V	8000Lm	6000-6500k 2800-3200k	350x295x65mm	4 cái/thùng	<b>2.721.400</b>
	FLD-150T FLD-150V	12.000Lm	6000-6500k 2800-3200k	395x315x75mm	1 cái/thùng	<b>3.463.900</b>
	FLD-200T FLD-200V	16.000Lm	6000-6500k 2800-3200k	400x350x53.5mm	1 cái/thùng	<b>5.174.400</b>

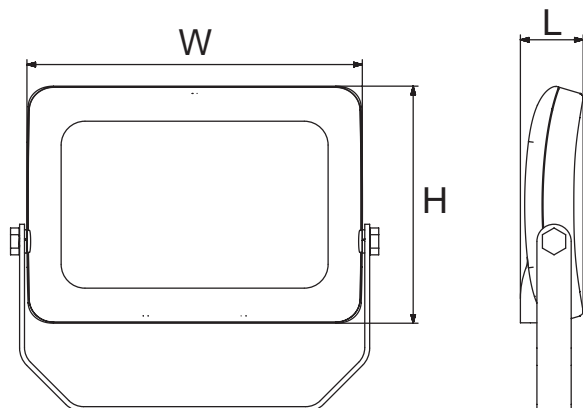





**New**



- Bảo hành 3 năm
- Hiệu suất 90 Lm/W
- Cấp độ bảo vệ IP65
- Thân nhôm bền bỉ, thiết kế gọn nhẹ
- Tiết kiệm điện năng, tuổi thọ cao 30.000 giờ
- Dễ dàng lắp đặt và sử dụng
- Ánh sáng đều tốt cho mắt
- Không có tia hồng ngoại, tia cực tím
- Ánh sáng tức thì, không nhấp nháy, không gây ồn.

**DIALux**  
German Technology

Seri FLD2	Mã hàng Model	Quang thông Lumens	Nhiệt độ màu CCT	Kích thước Size	Đóng gói Package	Đơn giá (VND)
	FLD2-10T FLD2-10V	900 lm	6000-6500k 2800-3200k	115x102x25mm	1 cái/hộp 20 cái/thùng	<b>369.900</b>
	FLD2-20T FLD2-20V	1800 lm	6000-6500k 2800-3200k	150x133x29mm	1 cái/hộp 10 cái/thùng	<b>581.900</b>
	FLD2-30T FLD2-30V	2700 lm	6000-6500k 2800-3200k	180x157x32mm	1 cái/hộp 10 cái/thùng	<b>768.900</b>
	FLD2-50T FLD2-50V	4500 lm	6000-6500k 2800-3200k	233x205x40mm	1 cái/hộp 5 cái/thùng	<b>1.098.900</b>
	FLD2-100T FLD2-100V	10.000 lm	6000-6500k 2800-3200k	338x248x98mm	1 cái/thùng	<b>2.721.400</b>
	FLD2-150T FLD2-150V	15.000 lm	6000-6500k 2800-3200k	338x248x98mm	1 cái/thùng	<b>3.463.900</b>
	FLD2-200T FLD2-200V	20.000 lm	6000-6500k 2800-3200k	414x305x103mm	1 cái/thùng	<b>5.174.400</b>

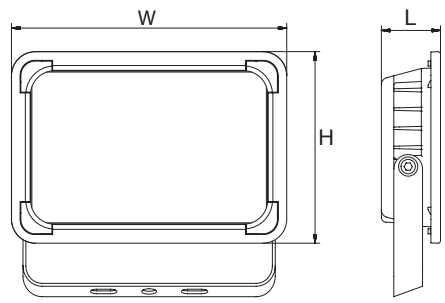



Công suất đa dạng 10W - 20W - 30W - 50W - 100W - 150W - 200W - 300W - 400W - 500W - 600W - 800W - 1000W

Viền đèn làm bằng hợp kim nhôm, bề mặt được sơn tĩnh điện truyền nhiệt tốt

Ngăn phản chiếu qua kính, hệ số phản xạ lên đến 96%

Vòng đai: sử dụng chất liệu cao su bảo vệ môi trường, chống chịu các tác động thời tiết tốt

Viền đèn làm bằng hợp kim nhôm, bề mặt được sơn tĩnh điện truyền nhiệt tốt



1: Mặt kính trong suốt, chịu va đập cao, tốc độ truyền sáng lên đến 95%

2: PCB làm bằng nhôm dẫn nhiệt cao, cách điện 100%, tiêu chuẩn UL  
3: Chip LED có độ bền, hiệu suất phát sáng cao

4: Driver có độ bền, ổn định cao

5: Dây cáp cao su chịu được các tác động thời tiết tốt

6: Giá đỡ sắt chịu lực cao, bề mặt sơn tĩnh điện

# Led Pha seri FLD3



Seri FLD3		Mã hàng Model	Quang thông Lumens	Nhiệt độ màu CCT	Kích thước Size (WxHxL)	Đóng gói Package	Đơn giá (VND)
	10W FLD3-10T FLD3-10V	1200Lm	6000-6500k 2800-3200k	162x147x36mm	1 cái/hộp 20 cái/thùng	<b>369.900</b>	
	20W FLD3-20T FLD3-20V	2400Lm	6000-6500k 2800-3200k	180x161x36mm	1 cái/hộp 20 cái/thùng	<b>581.900</b>	
	30W FLD3-30T FLD3-30V	3600Lm	6000-6500k 2800-3200k	235x205x36mm	1 cái/hộp 10 cái/thùng	<b>768.900</b>	
	50W FLD3-50T FLD3-50V	6000Lm	6000-6500k 2800-3200k	235x205x36mm	1 cái/hộp 10 cái/thùng	<b>1.098.900</b>	
	100W FLD3-100T FLD3-100V	12.000Lm	6000-6500k 2800-3200k	347x290x47mm	1 cái/hộp 4 cái/thùng	<b>2.721.400</b>	
	150W FLD3-150T FLD3-150V	18.000Lm	6000-6500k 2800-3200k	435x352x60mm	1 cái/thùng	<b>3.463.900</b>	
	200W FLD3-200T FLD3-200V	24.000Lm	6000-6500k 2800-3200k	435x352x60mm	1 cái/thùng	<b>5.174.400</b>	
	300W FLD3-300T FLD3-300V	36.000Lm	6000-6500k 2800-3200k	542x443x70mm	1 cái/thùng	<b>9.075.000</b>	
	400W FLD3-400T FLD3-400V	48.000Lm	6000-6500k 2800-3200k	658x537x154mm	1 cái/thùng	<b>20.130.000</b>	
	500W FLD3-500T FLD3-500V	60.000Lm	6000-6500k 2800-3200k	658x537x154mm	1 cái/thùng	<b>23.397.000</b>	
	600W FLD3-600T FLD3-600V	72.000Lm	6000-6500k 2800-3200k	658x537x154mm	1 cái/thùng	<b>26.125.000</b>	
	800W FLD3-800T FLD3-800V	96.000Lm	6000-6500k 2800-3200k	748x762x154mm	1 cái/thùng	<b>51.018.000</b>	
	1000W FLD3-1000T FLD3-1000V	120.000Lm	6000-6500k 2800-3200k	748x762x154mm	1 cái/thùng	<b>58.245.000</b>	

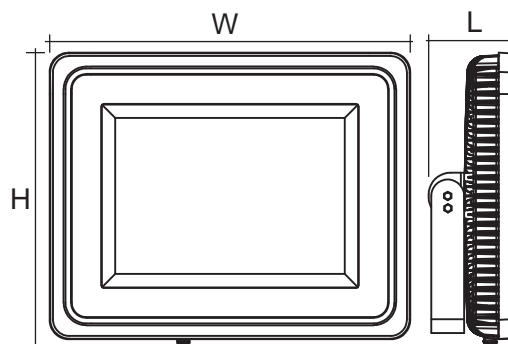

# Led Pha seri FLD5



Seri FLD5	Mã hàng Model	Quang thông Lumens	Nhiệt độ màu CCT	Kích thước Size (WxHxL)	PF	Đóng gói Package	Đơn giá (VND)
	<b>10W</b> FLD5-10T FLD5-10V	1100Lm	6000-6500k 2800-3200k	104x128x27mm	0.5	1 cái/hộp 36 cái/thùng	<b>257.300</b>
	<b>20W</b> FLD5-20T FLD5-20V	2200Lm	6000-6500k 2800-3200k	125x155x28mm	0.5	1 cái/hộp 30 cái/thùng	<b>416.400</b>
	<b>30W</b> FLD5-30T FLD5-30V	3300Lm	6000-6500k 2800-3200k	168x213x30mm	0.9	1 cái/hộp 20 cái/thùng	<b>524.000</b>
	<b>50W</b> FLD5-50T FLD5-50V	5500Lm	6000-6500k 2800-3200k	200x241x36mm	0.9	1 cái/hộp 12 cái/thùng	<b>655.000</b>
	<b>100W</b> FLD5-100T FLD5-100V	12000Lm	6000-6500k 2800-3200k	282x321x38mm	0.9	1 cái/hộp 4 cái/thùng	<b>1.487.700</b>
	<b>150W</b> FLD5-150T FLD5-150V	18000Lm	6000-6500k 2800-3200k	420x333x51mm	0.9	1 cái/hộp 4 cái/thùng	<b>2.481.900</b>
	<b>200W</b> FLD5-200T FLD5-200V	24000Lm	6000-6500k 2800-3200k	470x385x51mm	0.9	1 cái/hộp 3 cái/thùng	<b>3.560.200</b>
	<b>300W</b> FLD5-300T FLD5-300V	36000Lm	6000-6500k 2800-3200k	599x442x62mm	0.9	1 cái/thùng	<b>7.998.800</b>
	<b>400W</b> FLD5-400T FLD5-400V	48000Lm	6000-6500k 2800-3200k	599x442x62mm	0.9	1 cái/thùng	<b>9.470.700</b>

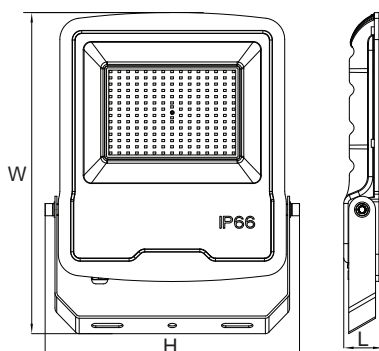

**New**



## DIALux

German Technology

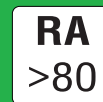
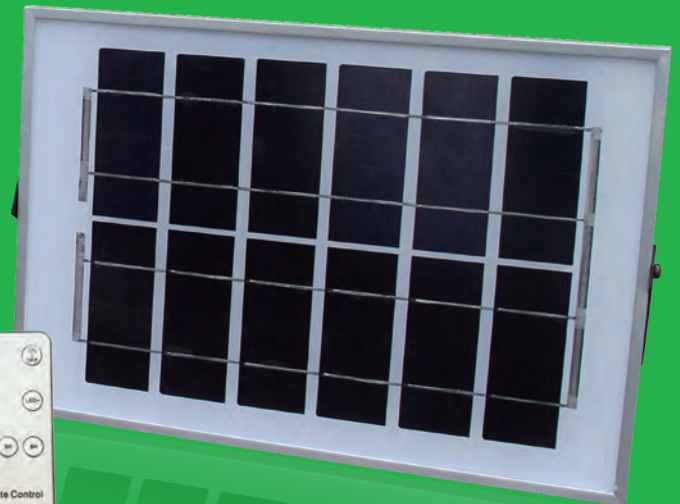

### ĐẶC ĐIỂM KỸ THUẬT:

- Hiệu suất chiếu sáng cao, tản nhiệt tốt.
- Có nhiều công suất chiếu sáng: 20W, 30W, 50W, 100W, 200W, 300W
- Ánh sáng: Trắng, vàng
- Sử dụng điện năng lượng mặt trời
- Pin tích điện Lithium
- Màn hình hiển thị sạc năng lượng trên đèn
- Cấp bảo vệ IP 65, khả năng chống nước, chống bụi, va đập...
- Tuổi thọ cao: 30.000 giờ
- Lắp đặt nhanh, tiết kiệm chi phí
- Không tốn chi phí tiền điện khi sử dụng
- Thời gian sử dụng khi sạc đầy là 12 giờ

### ỨNG DỤNG:

- Chiếu sáng khu sân vườn, công viên, đường phố, khu đô thị, khu nghỉ dưỡng, resort...

# LED Pha Năng Lượng Mặt Trời



Seri SFLD	Mã hàng Model	Quang thông Lumens	Công suất tấm pin (Wp)	Kích thước đèn WxHxL (mm)	Kích thước tấm pin WxHxL (mm)	Đóng gói Package	Đơn giá (VNĐ)
	SFLD-20T SFLD-20V	360Lm	6Wp	203x237x40	368x190x20	1 cái/hộp 12 cái/thùng	<b>1.672.000</b>
	SFLD-30T SFLD-30V	480Lm	9Wp	203x237x40	368x240x20	1 cái/hộp 12 cái/thùng	<b>1.888.000</b>
	SFLD-50T SFLD-50V	960Lm	15Wp	203x237x40	373x316x20	1 cái/hộp 12 cái/thùng	<b>2.188.000</b>
	SFLD-100T SFLD-100V	2100Lm	20Wp	282x321x41	374x376x20	1 cái/hộp 4 cái/thùng	<b>3.704.000</b>
	SFLD-200T SFLD-200V	4000Lm	35Wp	333x420x51	723x361x27	1 cái/hộp 4 cái/thùng	<b>6.800.000</b>
	SFLD-300T SFLD-300V	5800Lm	40Wp	385x470x51	703x451x27.5	1 cái/hộp 3 cái/thùng	<b>9.180.000</b>

1-5 giờ đầu độ sáng 80-100%	6-10 giờ sau độ sáng 40-50%	2 giờ cuối độ sáng 20%
-----------------------------	-----------------------------	------------------------

## Dây điện nối dài cho đèn Solar

	Mã số / Diễn giải	Đơn giá (VNĐ)
	<b>DCW275-5</b> Dây điện nối dài 2x0.75mm <sup>2</sup> , 5m, dùng cho SFLD 20W-200W	<b>331.900</b>
	<b>DCW275-10</b> Dây điện nối dài 2x0.75mm <sup>2</sup> , 10m, dùng cho SFLD 20W-200W	<b>536.000</b>
	<b>DCW2150-5</b> Dây điện nối dài 2x1.5mm <sup>2</sup> , 5m, dùng cho SFLD 300W	<b>553.000</b>
	<b>DCW2150-10</b> Dây điện nối dài 2x1.5mm <sup>2</sup> , 10m, dùng cho SFLD 300W	<b>919.000</b>

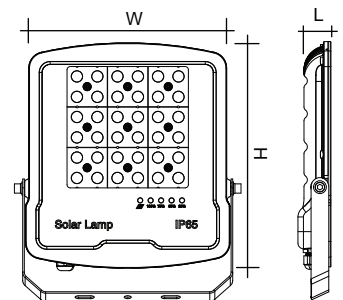

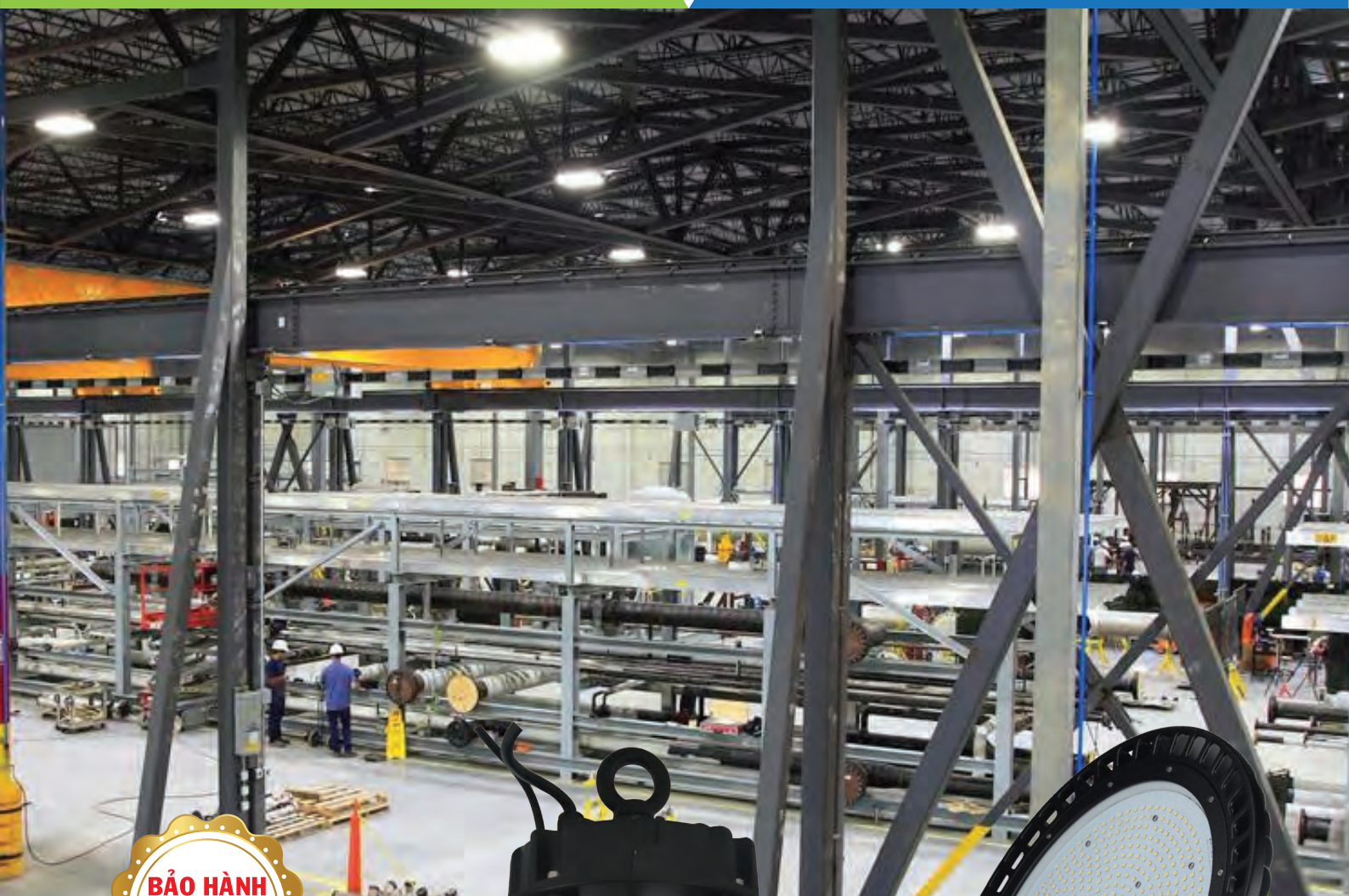

## DIALux

### German Technology

- Bảo hành 5 năm
- Hiệu suất chiếu sáng cao 130 lm/W
- Cấp độ bảo vệ IP65
- Thân nhôm bền bỉ, thiết kế gọn nhẹ

- Tiết kiệm điện năng, tuổi thọ cao 50.000 giờ
- Dễ dàng lắp đặt và sử dụng
- Ánh sáng đều tốt cho mắt
- Không có tia hồng ngoại, tia cực tím
- Ánh sáng tức thì, không nhấp nháy, không gây ồn.

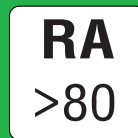
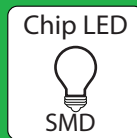
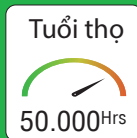

## Bảo Hành 5 Năm

Seri HBE	Mã hàng Model	Công suất Watt	Quang thông Lumens	Nhiệt độ màu CCT	Kích thước WxH mm	Đóng gói Package	Đơn giá (VND)
	HBE-100T	100W	13.000Lm	6500 - 6800k	Ø298x168mm	1 cái/thùng	<b>3.234.000</b>
	HBE-150T	150W	19.500Lm	6500 - 6800k	Ø298x193mm	1 cái/thùng	<b>3.733.000</b>
	HBE-200T	200W	26.000Lm	6500 - 6800k	Ø360x215mm	1 cái/thùng	<b>5.852.400</b>
	HBE-240T	240W	32.000Lm	6500 - 6800k	Ø360x215mm	1 cái/thùng	<b>6.906.900</b>

## Bảo Hành 5 Năm

Seri HBE2	Mã hàng Model	Công suất Watt	Quang thông Lumens	Nhiệt độ màu CCT	Kích thước WxH mm	Đóng gói Package	Đơn giá (VND)	
	HBE2-100T	100W	14.000Lm	6500 - 6800k	Ø270x160mm	1 cái/thùng	<b>3.234.000</b>	
	HBE2-150T	150W	21.000Lm	6500 - 6800k	Ø310x160mm	1 cái/thùng	<b>3.733.000</b>	
	HBE2-200T	200W	28.000Lm	6500 - 6800k	Ø310x170mm	1 cái/thùng	<b>5.852.400</b>	
	MS-HBE2	Cảm biến Microwave sử dụng cho đèn HBE2						<b>1.149.200</b>

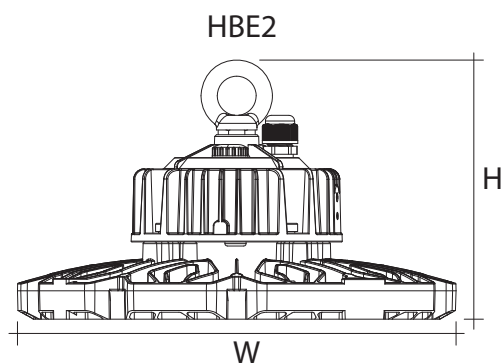
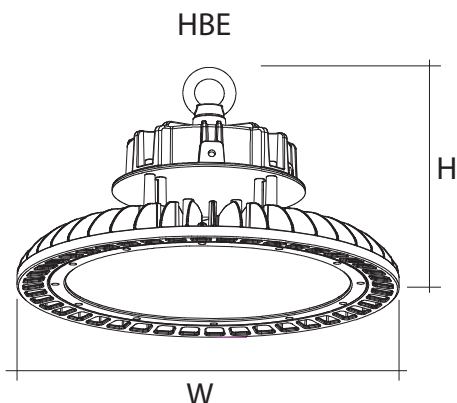



## Bảo Hành 5 Năm

### Seri HBU

Mã hàng Model	Công suất Watt	Quang thông Lumens	Nhiệt độ màu CCT	Kích thước WxH mm	Đóng gói Package	Đơn giá (VND)
<b>HBU-100T</b>	100W	12.000Lm	6500 - 6800k	Ø280x220mm	1 cái/thùng	<b>4.997.200</b>
<b>HBU-150T</b>	150W	18.000Lm	6500 - 6800k	Ø340x220mm	1 cái/thùng	<b>6.249.800</b>
<b>HBU-200T</b>	200W	24.000Lm	6500 - 6800k	Ø400x220mm	1 cái/thùng	<b>9.543.800</b>
<b>HBU-240T</b>	240W	28.800Lm	6500 - 6800k	Ø400x220mm	1 cái/thùng	<b>10.645.700</b>

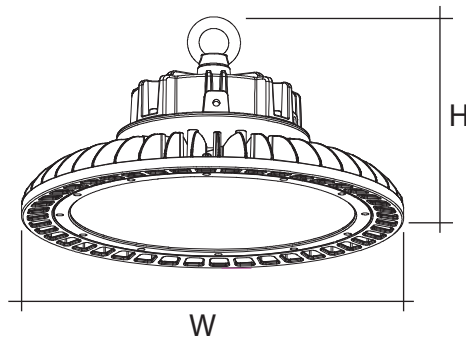

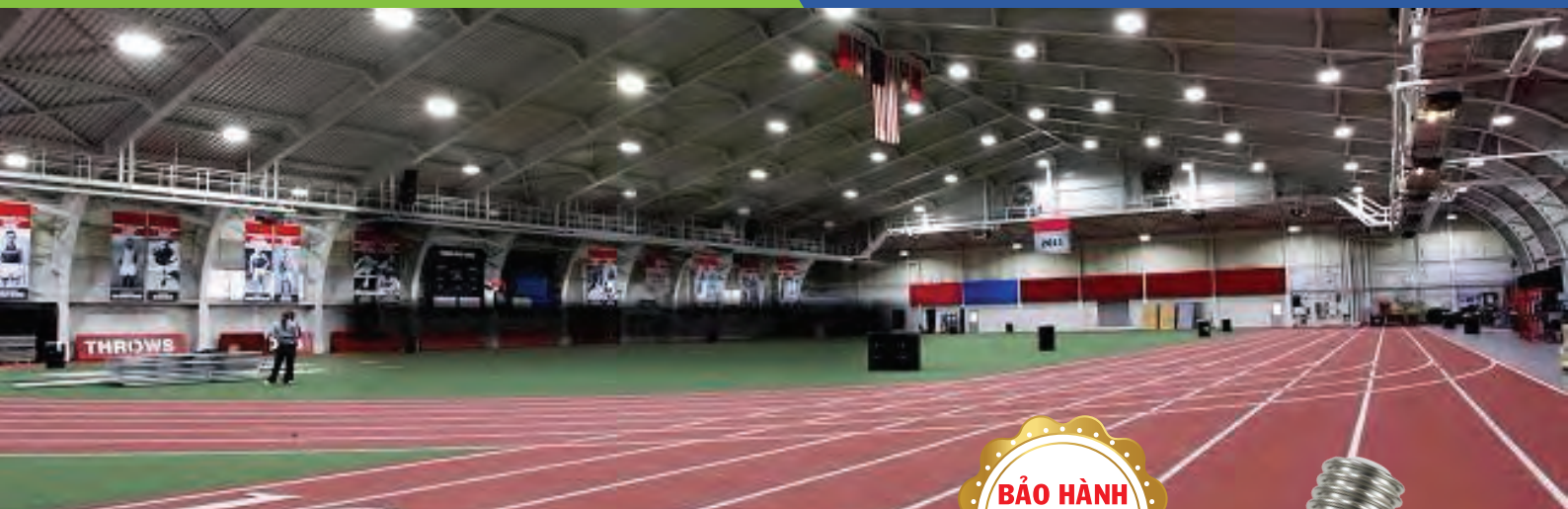

- Hiệu suất sáng 120 lm/W
- Ánh sáng trung thực Ra>80
- Giải nhiệt tốt, tuổi thọ cao
- Chất liệu: Khung bộ đèn làm bằng hợp kim nhôm, mặt sau làm bằng kim loại sơn tĩnh điện giúp tản nhiệt nhanh, tăng tuổi thọ của chip LED
- Sử dụng tấm dẫn sáng có hệ số truyền sáng cao, giúp ánh sáng phân bố đồng đều
- Đèn LED sử dụng chip Led có hiệu suất phát sáng cao, tiết kiệm điện, chất lượng ánh sáng tốt cho mắt
- Lắp đặt dễ dàng, gọn nhẹ, tiết kiệm chi phí, đui đèn E40



**DIALux**  
German Technology

Seri HBV2	Mã hàng Model	Quang thông Lumens	Nhiệt độ màu CCT	Kích thước Size	Đóng gói Package	Đơn giá (VND)
 <b>80W</b>	HBV2-80T	8500 lm	6500 - 6800k	278x206mm	1 cái/hộp 2 cái/thùng	<b>1.137.700</b>
 <b>100W</b>	HBV2-100T	12000 lm	6500 - 6800k	278x206mm	1 cái/hộp 2 cái/thùng	<b>1.612.400</b>
 <b>150W</b>	HBV2-150T	18000 lm	6500 - 6800k	340x213mm	1 cái/hộp 2 cái/thùng	<b>2.477.500</b>

## Bảo Hành 3 Năm

### Seri HBV (không bao gồm chóa)

Mã hàng Model	Công suất Watt	Quang thông Lumens	Nhiệt độ màu CCT	Kích thước Size	Đóng gói Package	Đơn giá (VND)
<b>New</b> HBV-65T	65W	5800Lm	6500 - 6800k	145x217mm	1 cái/hộp 4 cái/thùng	<b>822.200</b>
HBV-80T	80W	7800Lm	6500 - 6800k	179x229mm	1 cái/hộp 4 cái/thùng	<b>1.032.000</b>
HBV-100T	100W	9500Lm	6500 - 6800k	190x270mm	1 cái/hộp 4 cái/thùng	<b>1.531.500</b>
HBV-120T	120W	10.800Lm	6500 - 6800k	230x306mm	1 cái/hộp 4 cái/thùng	<b>2.194.500</b>

### Chóa Đèn Nhà Xưởng sử dụng cho seri HBV

Mã hàng Model	Công suất Watt	Kích thước W1xW2xHmm	Đơn giá (VNĐ)
<b>New</b> RFL-65	65W	Ø345x145x11mm	<b>111.100</b>
RFL-80	80W	Ø366x170x11mm	<b>202.200</b>
RFL-100	100W	Ø412x190x12mm	<b>202.200</b>
RFL-120	120W	Ø412x190x12mm	<b>273.800</b>

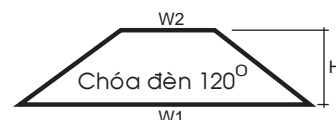

### Seri HBS (bao gồm chóa)

Mã hàng Model	Công suất Watt	Quang thông Lumens	Nhiệt độ màu CCT	Chóa đèn	Đóng gói Package	Đơn giá (VND)
HBS-60T	60W	5300 lm	6500 - 6800k	120°	1 cái/hộp 9 cái/thùng	<b>1.234.800</b>
HBS-80T	80W	7200 lm	6500 - 6800k	120°	1 cái/hộp 9 cái/thùng	<b>1.490.000</b>
HBS-100T	100W	10.000 lm	6500 - 6800k	120°	1 cái/hộp 9 cái/thùng	<b>2.148.300</b>



Seri HBL (bao gồm chóa)	Mã hàng Model	Quang thông Lumens	Nhiệt độ màu CCT	Kích thước Size (WxH)	Chóa đèn	Đóng gói Package	Đơn giá (VND)
	HBL-100T	10.000Lm	6500K	272x230mm	90°	1 cái/hộp 1 cái/thùng	<b>5.385.300</b>
	HBL-150T	15.000Lm	6500K	272x288mm	120°	1 cái/hộp 1 cái/thùng	<b>7.985.700</b>
	HBL-200T	20.000Lm	6500K	272x338mm	120°	1 cái/hộp 1 cái/thùng	<b>11.070.200</b>
	HBL-240T	24.000Lm	6500K	272x306mm	120°	1 cái/hộp 1 cái/thùng	<b>12.843.600</b>

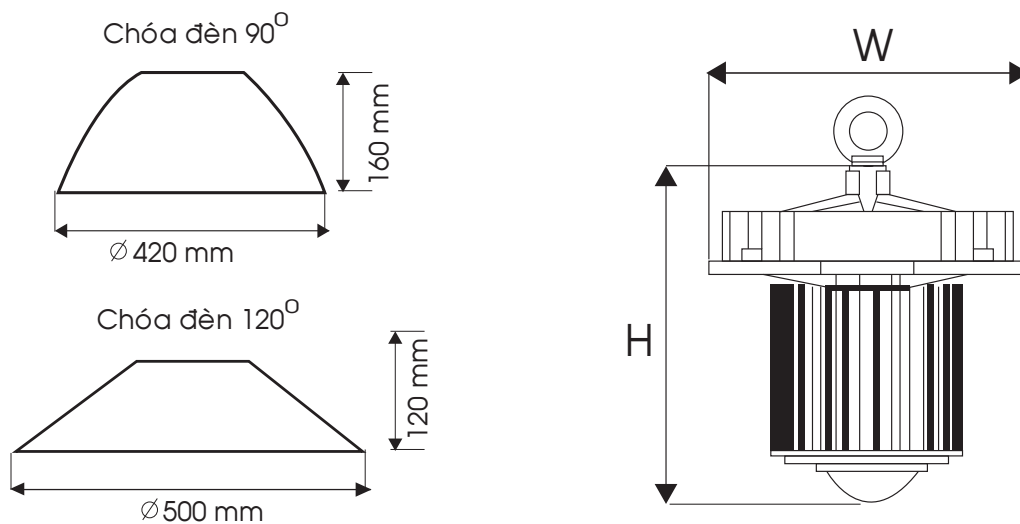

**New****DIALux****German Technology****ĐẶC ĐIỂM KỸ THUẬT:**

- Hiệu suất chiếu sáng cao, 130 Lm/W
- Đèn được đúc nhôm nguyên khối, sơn tĩnh điện cao cấp giúp tản nhiệt nhanh
- Đa dạng công suất từ 100W đến 400W phù hợp cho nhu cầu sử dụng
- Ánh sáng: Trắng (6500K), Ra>80
- Góc chiếu 110<sup>o</sup> phân bố ánh sáng đều.
- Lắp đặt nhanh, tiết kiệm chi phí
- Tiết kiệm điện năng, thân thiện môi trường

**ỨNG DỤNG:**

- Chiếu sáng kho xưởng, nhà máy, nhà xe, sân bay, khu thể thao, siêu thị...



Seri LHB	Mã hàng Model	Quang thông Lumens	Nhiệt độ màu CCT	Kích thước Size (WxLxH)	Đóng gói Package	Đơn giá (VNĐ)
 <b>100W</b>	LHB-100T LHB-100V LHB-100N	13.000 Lm	6000-6500K 2800-3200K 4000-4500K	415x319x59mm	1 cái/thùng	<b>3.380.300</b>
 <b>150W</b>	LHB-150T LHB-150V LHB-150N	19.500 Lm	6000-6500K 2800-3200K 4000-4500K	615x319x59mm	1 cái/thùng	<b>4.257.000</b>
 <b>200W</b>	LHB-200T LHB-200V LHB-200N	26.000 Lm	6000-6500K 2800-3200K 4000-4500K	815x319x59mm	1 cái/thùng	<b>6.150.100</b>
 <b>240W</b>	LHB-240T LHB-240V LHB-240N	31.200 Lm	6000-6500K 2800-3200K 4000-4500K	815x319x59mm	1 cái/thùng	<b>6.979.500</b>
 <b>300W</b>	LHB-300T LHB-300V LHB-300N	39.000 Lm	6000-6500K 2800-3200K 4000-4500K	1215x319x59mm	1 cái/thùng	<b>8.919.900</b>
 <b>400W</b>	LHB-400T LHB-400V LHB-400N	52.000 Lm	6000-6500K 2800-3200K 4000-4500K	1215x319x59mm	1 cái/thùng	<b>11.830.500</b>



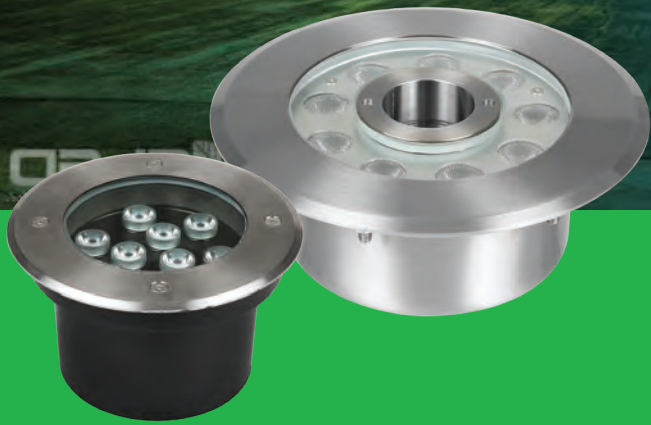

**DIALux**

**German Technology**



**ĐẶC ĐIỂM KỸ THUẬT:**

- Thân làm bằng chất liệu nhôm và kính cường lực cao cấp.
- Vỏ làm bằng thép không gỉ, chống va đập
- Có nhiều dòng công suất: 6W, 9W, 12W, 18W, 24W, 32W
- Chế độ màu: Trắng, vàng, trung tính, RGB
- Chống thấm nước IP65, IP68
- Tản nhiệt tốt, tuổi thọ cao: 30.000 giờ
- Tiết kiệm điện năng, thân thiện môi trường

**ỨNG DỤNG**

- Chiếu sáng rộng rãi trong vườn, quảng trường, biệt thự, nhà ở, nhà hàng, bãi đậu xe...



Seri LUG	Mã hàng Model	Quang thông Lumens	Nhiệt độ màu CCT	Kích thước Size	Đục lỗ Cut out	Đóng gói Package	Đơn giá (VNĐ)
 IP65 <b>9W</b>	LUG-9T LUG-9V	720Lm	6500K 3000K	Ø160x95mm	Ø110mm	1 cái/hộp 20 cái/thùng	<b>1.098.900</b>
 IP65 <b>12W</b>	LUG-12T LUG-12V	960Lm	6500K 3000K	Ø160x95mm	Ø140mm	1 cái/hộp 12 cái/thùng	<b>1.185.800</b>
 IP65 <b>18W</b>	LUG-18T LUG-18V	1440Lm	6500K 3000K	Ø220x95mm	Ø180mm	1 cái/hộp 8 cái/thùng	<b>1.760.000</b>
 IP65 <b>24W</b>	LUG-24T LUG-24V	1920Lm	6500K 3000K	Ø220x95mm	Ø200mm	1 cái/hộp 6 cái/thùng	<b>2.070.200</b>
 IP65 <b>32W</b>	LUG-32T LUG-32V	2560Lm	6500K 3000K	Ø300x95mm	Ø200mm	1 cái/hộp 6 cái/thùng	<b>2.652.100</b>

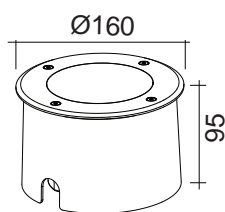

9W - 12W

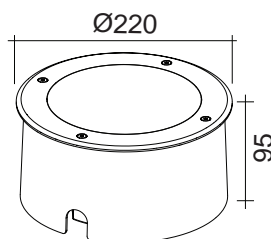

18W - 24W

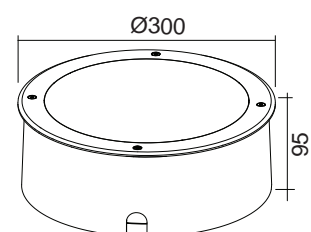

32W



Seri LUG2	Mã hàng Model	Quang thông Lumens	Nhiệt độ màu CCT	Kích thước Size	Đục lỗ Cut out	Đóng gói Package	Đơn giá (VNĐ)
 IP68 <b>9W</b>	LUG2-9T LUG2-9V	720Lm	6500K 3000K	Ø170x80mm	Ø115mm	1 cái/hộp 4 cái/thùng	<b>2.197.000</b>
 IP68 <b>12W</b>	LUG2-12T LUG2-12V	960Lm	6500K 3000K	Ø180x80mm	Ø126mm	1 cái/hộp 4 cái/thùng	<b>2.457.000</b>
 IP68 <b>18W</b>	LUG2-18T LUG2-18V	1440Lm	6500K 3000K	Ø230x80mm	Ø172mm	1 cái/thùng	<b>2.846.000</b>
 IP68 <b>24W</b>	LUG2-24T LUG2-24V	1920Lm	6500K 3000K	Ø250x80mm	Ø191mm	1 cái/thùng	<b>3.399.000</b>
 IP68 <b>36W</b>	LUG2-36T LUG2-36V	2880Lm	6500K 3000K	Ø385x130mm	Ø192mm	1 cái/thùng	<b>4.306.000</b>

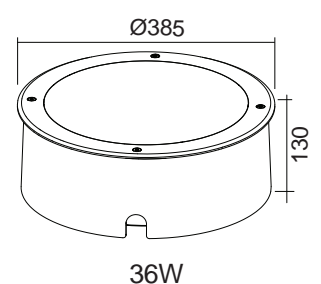
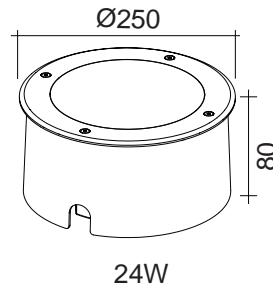
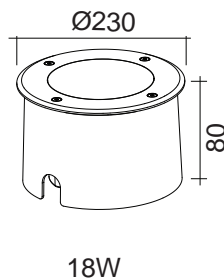
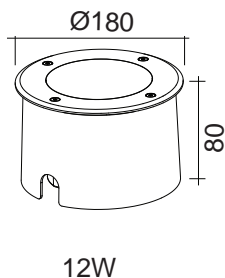
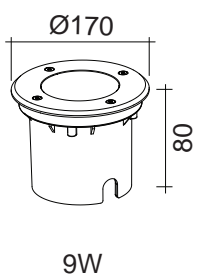

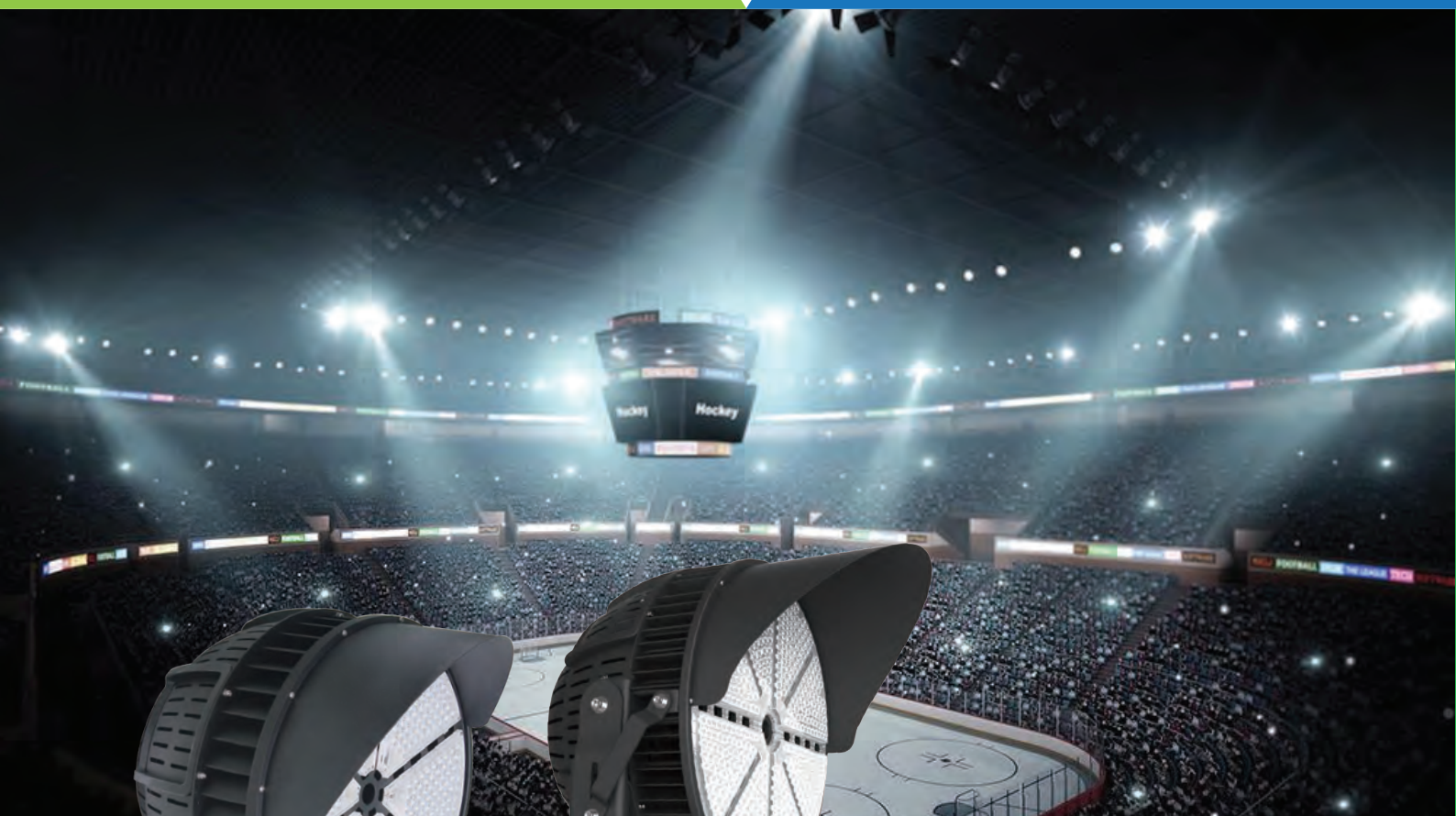





**DIALux****German Technology****ĐẶC ĐIỂM KỸ THUẬT:**

- Hiệu suất chiếu sáng cao, 150 Lm/W
- Thấu kính truyền sáng cao giúp phân bố ánh sáng đồng đều
- Có nhiều dòng công suất 400W, 500W, 600W, 750W, 1000W, 1200W
- Đèn thiết kế cấp độ bảo vệ cao: IP67
- Tuổi thọ cao: 50.000 giờ
- Chịu được sức gió cấp 17
- Lắp đặt nhanh, tiết kiệm chi phí
- Tiết kiệm điện năng, thân thiện môi trường

**ỨNG DỤNG:**

- Chiếu sáng sân thể thao, nhà hát, sân bay, công viên, quảng trường...

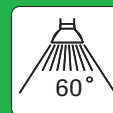
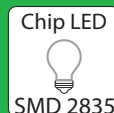

Seri LSL	Mã hàng Model	Quang thông Lumens	Nhiệt độ màu CCT	Góc chiếu Angle	Kích thước Size (mm)	Đóng gói Package	Đơn giá (VNĐ)
	<b>LSL-400T</b> <b>LSL-400V</b> <b>LSL-400N</b>	52.000 Lm	6000 - 6500K 2800 - 3200K 4000 - 4500K	30°	Ø360x410	1 cái/thùng	<b>28.303.000</b>
	<b>LSL-500T</b> <b>LSL-500V</b> <b>LSL-500N</b>	65.000 Lm	6000 - 6500K 2800 - 3200K 4000 - 4500K	30°	Ø360x410	1 cái/thùng	<b>29.425.000</b>
	<b>LSL-600T</b> <b>LSL-600V</b> <b>LSL-600N</b>	78.000 Lm	6000 - 6500K 2800 - 3200K 4000 - 4500K	15°	Ø460x521	1 cái/thùng	<b>57.238.500</b>
	<b>LSL-750T</b> <b>LSL-750V</b> <b>LSL-750N</b>	97.000 Lm	6000 - 6500K 2800 - 3200K 4000 - 4500K	15°	Ø460x521	1 cái/thùng	<b>67.138.500</b>
	<b>LSL-1000T</b> <b>LSL-1000V</b> <b>LSL-1000N</b>	130.000 Lm	6000 - 6500K 2800 - 3200K 4000 - 4500K	12°	Ø521x571	1 cái/thùng	<b>77.038.500</b>
	<b>LSL-1200T</b> <b>LSL-1200V</b> <b>LSL-1200N</b>	156.000 Lm	6000 - 6500K 2800 - 3200K 4000 - 4500K	12°	Ø521x571	1 cái/thùng	<b>87.318.000</b>

**DIALux****German Technology**



### ĐẶC ĐIỂM KỸ THUẬT:

- Thân làm bằng chất liệu nhôm nguyên khối cao cấp
- Có nhiều dòng công suất: 35W, 55W, 75W, 100W, 150W
- Chế độ màu: Trắng, vàng, trung tính
- Cấp bảo vệ IP65 chống nước
- Tản nhiệt tốt, tuổi thọ cao: 50.000 giờ
- Bền, nhẹ, khó vỡ, chịu lực, chịu nhiệt cao
- Sử dụng đèn LED thay thế đèn truyền thống
- Tiết kiệm điện năng, thân thiện môi trường

### ỨNG DỤNG

- Chiếu sáng khu dân cư, công cộng, sân vườn, khu resort, hành lang đô thị...

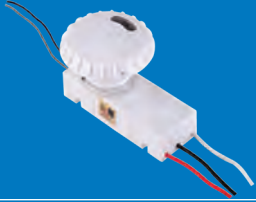
Seri LGL	Mã hàng Model	Quang thông Lumens	Nhiệt độ màu CCT	Kích thước Size (mm)	Đóng gói Package	Đơn giá (VNĐ)
	LGL-35T LGL-35V LGL-35N	4025Lm	6000 - 6500K 2800 - 3200K 4000 - 4500K	Ø380x670mm	1 cái/thùng	<b>5.551.700</b>
	LGL-55T LGL-55V LGL-55N	6325Lm	6000 - 6500K 2800 - 3200K 4000 - 4500K	Ø380x670mm	1 cái/thùng	<b>6.028.000</b>
	LGL-75T LGL-75V LGL-75N	8625Lm	6000 - 6500K 2800 - 3200K 4000 - 4500K	Ø380x670mm	1 cái/thùng	<b>8.143.300</b>
	LGL-100T LGL-100V LGL-100N	11.800Lm	6000 - 6500K 2800 - 3200K 4000 - 4500K	Ø450x770mm	1 cái/thùng	<b>10.593.000</b>
	LGL-150T LGL-150V LGL-150N	17.800Lm	6000 - 6500K 2800 - 3200K 4000 - 4500K	Ø450x670mm	1 cái/thùng	<b>11.803.000</b>

Phụ kiện Seri LGL	Mã hàng Model	Đơn giá (VNĐ)
	<b>MS/LGL</b> Cảm biến chuyển động cho đèn Garden Light	<b>1.586.200</b>
	<b>SP/LGL</b> Bảo vệ quá điện áp cho đèn Garden Light	<b>316.800</b>



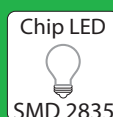
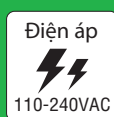

Phụ kiện Seri LGL	Mã hàng Model	Đơn giá (VNĐ)
	<b>PTC/LGL</b> Cảm biến quang cho đèn Garden Light	<b>632.500</b>
	<b>SC/LGL</b> Cảm biến quang cho đèn Garden Light	<b>444.400</b>

**DIALux****German Technology****ĐẶC ĐIỂM KỸ THUẬT:**

- Hiệu suất chiếu sáng cao, 130 Lm/W
- Có nhiều dòng công suất: 30W, 40W, 50W, 60W, 80W
- Đui đèn có thể lắp ở 2 đầu, chiếu sáng 360°
- Cấp bảo vệ IP65 chống nước
- Tản nhiệt tốt, tuổi thọ cao: 50.000 giờ
- Phù hợp thay thế cho đèn Halogen truyền thống
- Tiết kiệm điện năng, thân thiện môi trường

**ỨNG DỤNG:**

- Chiếu sáng cảnh quan, sân vườn, đường trục đô thị, vỉa hè...

Seri LGL2	Mã hàng Model	Quang thông Lumens	Nhiệt độ màu CCT	Kích thước Size (mm)	Đóng gói Package	Đơn giá (VNĐ)
 	<b>LGL2-30T</b> <b>LGL2-30V</b> <b>LGL2-30N</b>	3900Lm	6000 - 6500K 2800 - 3200K 4000 - 4500K	Ø132x170mm	1 cái/thùng	<b>1.815.000</b>
 	<b>LGL2-40T</b> <b>LGL2-40V</b> <b>LGL2-40N</b>	5200Lm	6000 - 6500K 2800 - 3200K 4000 - 4500K	Ø132x170mm	1 cái/thùng	<b>1.906.300</b>
 	<b>LGL2-50T</b> <b>LGL2-50V</b> <b>LGL2-50N</b>	6500Lm	6000 - 6500K 2800 - 3200K 4000 - 4500K	Ø132x170mm	1 cái/thùng	<b>2.086.700</b>
 	<b>LGL2-60T</b> <b>LGL2-60V</b> <b>LGL2-60N</b>	7800Lm	6000 - 6500K 2800 - 3200K 4000 - 4500K	Ø132x170mm	1 cái/thùng	<b>2.522.300</b>
 	<b>LGL2-80T</b> <b>LGL2-80V</b> <b>LGL2-80N</b>	10.400Lm	6000 - 6500K 2800 - 3200K 4000 - 4500K	Ø132x200mm	1 cái/thùng	<b>3.045.900</b>



### ĐẶC ĐIỂM KỸ THUẬT:

- Hiệu suất chiếu sáng cao, 130 Lm/W
- Có nhiều công suất chiếu sáng: 40W, 80W, 120W
- Ánh sáng: Trắng, vàng, trung tính
- Thấu kính truyền sáng cao giúp phân bố ánh sáng đồng đều
- Cấp bảo vệ IP 67, khả năng chống nước, chống bụi, va đập...
- Hạn chế tối đa các trường hợp xảy ra sự cố cháy nổ
- Lắp đặt nhanh, tiết kiệm chi phí
- Tiết kiệm điện năng, thân thiện môi trường



### ỨNG DỤNG:

- Chiếu sáng cho hầm khai thác, mỏ khoáng sản, nhà máy xăng dầu, khí đốt
- hầm để xe, đường hầm, các nhà máy khu công nghiệp...



**DIALux**  
German Technology

Seri LEPL	Mã hàng Model	Quang thông Lumens	Nhiệt độ màu CCT	Kích thước WxHxL(mm)	Đóng gói Package	Đơn giá (VNĐ)
	LEPL-40T LEPL-40V LEPL-40N	5200Lm	6000 - 6500K 2800 - 3200K 4000 - 4500K	650x130x206mm	1 cái/thùng	<b>14.595.900</b>
	LEPL-80T LEPL-80V LEPL-80N	10.400Lm	6000 - 6500K 2800 - 3200K 4000 - 4500K	1298x130x206mm	1 cái/thùng	<b>19.122.400</b>
	LEPL-120T LEPL-120V LEPL-120N	15.600Lm	6000 - 6500K 2800 - 3200K 4000 - 4500K	1298x130x206mm	1 cái/thùng	<b>28.556.000</b>





### ĐẶC ĐIỂM KỸ THUẬT:

- Có nhiều công suất chiếu sáng: 60W, 100W, 150W
- Ánh sáng: Trắng, vàng, trung tính
- Thấu kính truyền sáng cao giúp phân bố ánh sáng đồng đều
- Cấp bảo vệ IP 67, khả năng chống nước, chống bụi, va đập...
- Có vỏ bọc bên ngoài bảo vệ đèn
- Hạn chế tối đa các trường hợp xảy ra sự cố cháy nổ
- Lắp đặt nhanh, tiết kiệm chi phí
- Tiết kiệm điện năng, thân thiện môi trường



### ỨNG DỤNG:

- Chiếu sáng cho hầm khai thác, mỏ khoáng sản, nhà máy xăng dầu, khí đốt
- hầm để xe, đường hầm, các nhà máy khu công nghiệp...



**DIALux**  
German Technology

Seri LEPR	Mã hàng Model	Quang thông Lumens	Nhiệt độ màu CCT	Kích thước (mm)	Đóng gói Package	Đơn giá (VNĐ)
 60W	LEPR-60T LEPR-60V LEPR-60N	7500Lm	6000 - 6500K 2800 - 3200K 4000 - 4500K	Ø215x196mm	2 cái/thùng	<b>12.437.700</b>
 100W	LEPR-100T LEPR-100V LEPR-100N	12.500Lm	6000 - 6500K 2800 - 3200K 4000 - 4500K	Ø345x225mm	1 cái/thùng	<b>16.245.900</b>
 150W	LEPR-150T LEPR-150V LEPR-150N	18.750Lm	6000 - 6500K 2800 - 3200K 4000 - 4500K	Ø345x225mm	1 cái/thùng	<b>22.844.800</b>



## DIALux

German Technology

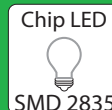
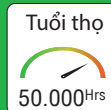
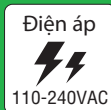

### ĐẶC ĐIỂM KỸ THUẬT:

- Đèn trang bị cảm biến chuyển động và cảm biến quang giúp tiết kiệm điện
- Thân làm bằng chất liệu nhôm nguyên khối cao cấp chống oxy hóa
- Kính cường lực, trong suốt giúp phân bố ánh sáng đều, bảo vệ chip LED
- Có nhiều dòng công suất: 30W, 60W, 90W, 120W, 150W
- Chế độ màu: Trắng, vàng, trung tính
- Cấp bảo vệ IP65 chống nước
- Tản nhiệt tốt, tuổi thọ cao: 50.000 giờ
- Bền, nhẹ, khó vỡ, chịu lực, chịu nhiệt cao
- Khả năng chống sét
- Sử dụng đèn LED thay thế đèn truyền thống

### ỨNG DỤNG

- Chiếu sáng đèn sân thể thao, sân vườn, đường phố, giao thông công cộng, bệnh viện, trường học...

# LED Đường Đi Seri LST



Seri LST	Mã hàng Model	Quang thông Lumens	Nhiệt độ màu CCT	Kích thước Size (mm)	Đóng gói Package	Đơn giá (VNĐ)
	LST-30T LST-30V LST-30N	3900Lm	6000 - 6500K 2800 - 3200K 4000 - 4500K	601x250x95mm	1 cái/thùng	<b>4.125.000</b>
	LST-60T LST-60V LST-60N	7800Lm	6000 - 6500K 2800 - 3200K 4000 - 4500K	601x250x95mm	1 cái/thùng	<b>4.706.900</b>
	LST-90T LST-90V LST-90N	11.700Lm	6000 - 6500K 2800 - 3200K 4000 - 4500K	601x250x95mm	1 cái/thùng	<b>5.816.800</b>
	LST-120T LST-120V LST-120N	15.600Lm	6000 - 6500K 2800 - 3200K 4000 - 4500K	601x250x95mm	1 cái/thùng	<b>6.050.000</b>
	LST-150T LST-150V LST-150N	19.500Lm	6000 - 6500K 2800 - 3200K 4000 - 4500K	601x250x95mm	1 cái/thùng	<b>6.380.000</b>

Phụ kiện Seri LST	Mã hàng Model	Đơn giá (VNĐ)
	<b>MS/LST</b> Cảm biến chuyển động cho đèn Street Light	<b>1.480.600</b>

Phụ kiện Seri LST	Mã hàng Model	Đơn giá (VNĐ)
	<b>PTC/LST</b> Cảm biến quang cho đèn Street Light	<b>605.000</b>



## DIALux

German Technology

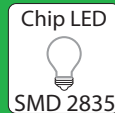

### ĐẶC ĐIỂM KỸ THUẬT:

- Thân làm bằng chất liệu nhôm nguyên khối cao cấp chống oxy hóa
- Kính cường lực, trong suốt giúp phân bổ ánh sáng đều, bảo vệ chip LED
- Đèn trang bị phụ kiện Sensor tắt/mở khi trời sáng hay tối
- Có nhiều dòng công suất: 100W, 150W, 200W, 240W, 300W
- Chế độ màu: Trắng, vàng, trung tính
- Cấp bảo vệ IP65 chống nước
- Tản nhiệt tốt, tuổi thọ cao: 50.000 giờ
- Bền, nhẹ, khó vỡ, chịu lực, chịu nhiệt cao
- Khả năng chống sét
- Sử dụng đèn LED thay thế đèn truyền thống

### ỨNG DỤNG

- Chiếu sáng đèn đường phố, giao thông công cộng, bệnh viện, trường học...

# LED Đường Đi Seri LST2



Seri LST2	Mã hàng Model	Quang thông Lumens	Nhiệt độ màu CCT	Kích thước Size (mm)	Đóng gói Package	Đơn giá (VNĐ)
 100W	LST2-100T LST2-100V LST2-100N	14.600Lm	6000 - 6500K 2800 - 3200K 4000 - 4500K	488x326x80mm	1 cái/thùng	<b>4.020.500</b>
 150W	LST2-150T LST2-150V LST2-150N	21.000Lm	6000 - 6500K 2800 - 3200K 4000 - 4500K	488x326x80mm	1 cái/thùng	<b>4.455.000</b>
 200W	LST2-200T LST2-200V LST2-200N	28.000Lm	6000 - 6500K 2800 - 3200K 4000 - 4500K	688x326x80mm	1 cái/thùng	<b>6.600.000</b>
 240W	LST2-240T LST2-240V LST2-240N	33.600Lm	6000 - 6500K 2800 - 3200K 4000 - 4500K	688x326x80mm	1 cái/thùng	<b>9.391.800</b>
 300W	LST2-300T LST2-300V LST2-300N	42.000Lm	6000 - 6500K 2800 - 3200K 4000 - 4500K	688x326x80mm	1 cái/thùng	<b>11.422.400</b>

## Phụ kiện LED Đường Đi seri LST2

Phụ kiện Seri LST2	Mã hàng Model	Đơn giá (VNĐ)	Phụ kiện Seri LST2	Mã hàng Model	Đơn giá (VNĐ)
	<b>SF/LST2</b> Bộ nối dạng trượt	632.500		<b>PTC/LST2</b> Cảm biến quang	632.500
	<b>AM/LST2</b> Bộ nối gắn tường	632.500		<b>PIR/LST2</b> Cảm biến thân nhiệt chuyển động	1.480.600
	<b>TM/LST2</b> Bát treo hình vuông	380.600		<b>MS/LST2</b> Cảm biến chuyển động	1.589.500
	<b>YM150/LST2</b> Bát treo hình chữ U dùng cho đèn 100-150W	380.600		<b>SC/LST2</b> Đầu nối cáp	380.600
	<b>YM300/LST2</b> Bát treo hình chữ U dùng cho đèn 200-300W	507.100		<b>SP12/LST2</b> Bảo vệ quá điện áp 12Kv	316.800
	<b>UM/LST2</b> Bộ nối đa năng	1.268.300		<b>SP20/LST2</b> Bảo vệ quá điện áp 20Kv	609.400

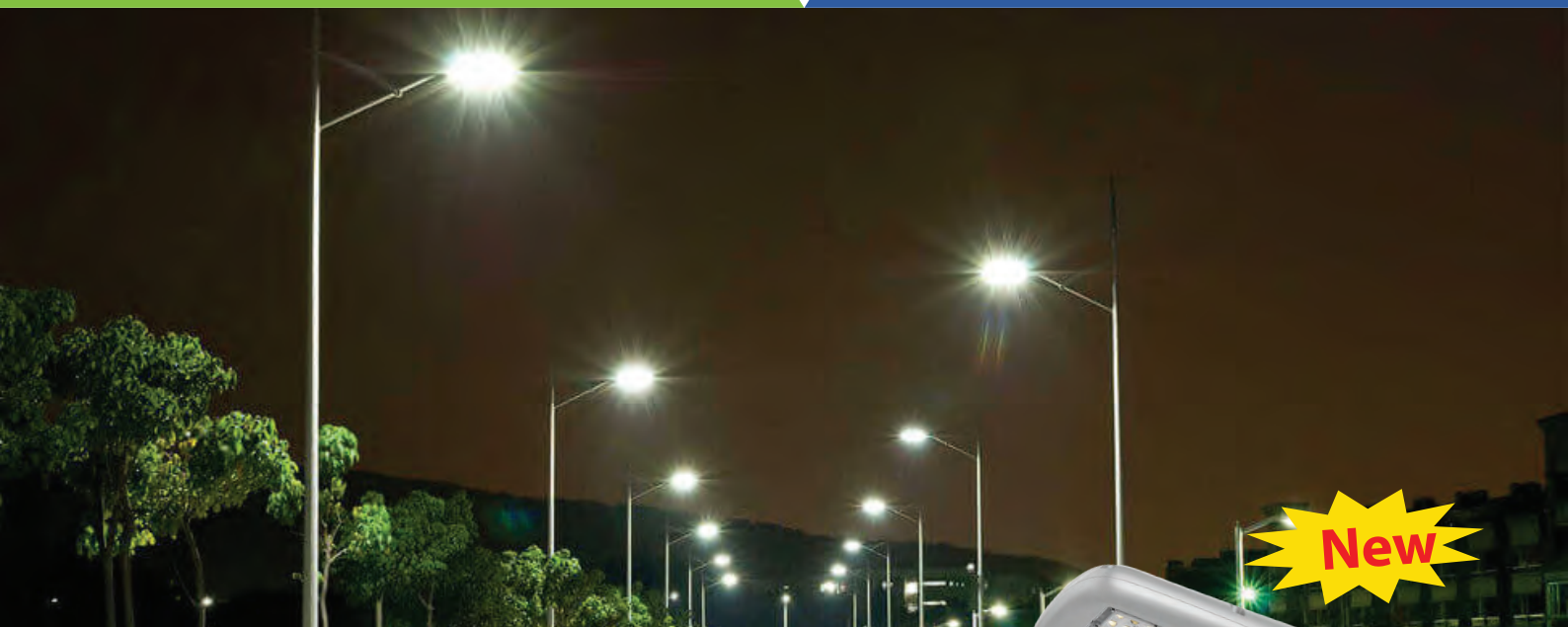

**New**

### ĐẶC ĐIỂM KỸ THUẬT:

- Thân làm bằng chất liệu nhựa và nhôm nguyên khối cao cấp
- Kính cường lực, trong suốt giúp phân bố ánh sáng đều, bảo vệ chip LED
- Chế độ màu: Trắng, vàng
- Cấp bảo vệ IP65 chống nước
- Tản nhiệt tốt, tuổi thọ cao: 50.000 giờ
- Bền, nhẹ, khó vỡ, chịu lực, chịu nhiệt cao
- Khả năng chống sét
- Sử dụng đèn LED thay thế đèn truyền thống



### ỨNG DỤNG

- Chiếu sáng đường phố, giao thông công cộng, bệnh viện, trường học...



**DIALux**  
German Technology

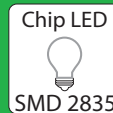
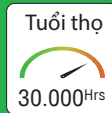

Seri LST3	Mã hàng Model	Quang thông Lumens	Nhiệt độ màu CCT	Kích thước Size (mm)	Góc chiếu Angle	Đóng gói Package	Đơn giá (VNĐ)
	<b>LST3-30T</b> <b>LST3-30V</b>	3600Lm	6000 - 6500K 2800 - 3200K	335x180x78mm	120°	1 cái/hộp 6 cái/thùng	<b>1.915.400</b>
	<b>LST3-50T</b> <b>LST3-50V</b>	5000Lm	6000 - 6500K 2800 - 3200K	335x180x78mm	120°	1 cái/hộp 6 cái/thùng	<b>2.211.300</b>
	<b>LST3-100T</b> <b>LST3-100V</b>	12.000Lm	6000 - 6500K 2800 - 3200K	301x152x75mm	100°	1 cái/hộp 6 cái/thùng	<b>3.488.000</b>

**New****DIALux****German Technology****ĐẶC ĐIỂM KỸ THUẬT:**

- Sử dụng 100% nguồn điện từ năng lượng mặt trời
- Thân làm bằng chất liệu nhôm nguyên khối cao cấp chống oxy hóa
- Kính cường lực, trong suốt giúp phân bổ ánh sáng đều, bảo vệ chip LED
- Cấp bảo vệ IP65 chống nước
- Tản nhiệt tốt, tuổi thọ cao: 50.000 giờ
- Bền, nhẹ, khó vỡ, chịu lực, chịu nhiệt cao
- Khả năng chống sét
- Sử dụng đèn LED thay thế đèn truyền thống

**ỨNG DỤNG**

- Chiếu sáng đèn sân thể thao, sân vườn, đường phố, giao thông công cộng, bệnh viện, trường học...



# LED Đường Đi NLMT Seri LSS

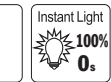

Seri LSS	Mã hàng Model	Quang thông Lumens	Nhiệt độ màu CCT	Kích thước WxHxL(mm)	Đóng gói Package	Đơn giá (VNĐ)
	LSS-12T LSS-12V LSS-12N	1650Lm	6000 - 6500K 2800 - 3200K 4000 - 4500K	580x318x72mm	1 cái/thùng	<b>10.184.900</b>
	LSS-18T LSS-18V LSS-18N	2520Lm	6000 - 6500K 2800 - 3200K 4000 - 4500K	580x318x72mm	1 cái/thùng	<b>10.549.000</b>
	LSS-24T LSS-24V LSS-24N	3360Lm	6000 - 6500K 2800 - 3200K 4000 - 4500K	580x318x72mm	1 cái/thùng	<b>10.946.100</b>

Phụ kiện Seri LSS	Mã hàng Model	Đơn giá (VNĐ)
	<b>BRA/LSS</b> Phụ kiện cho đèn LSS	<b>507.100</b>
	<b>BRB/LSS</b> Phụ kiện cho đèn LSS	<b>380.600</b>

Phụ kiện Seri LSS	Mã hàng Model	Đơn giá (VNĐ)
	<b>UM/LSS</b> Phụ kiện cho đèn LSS	<b>1.268.300</b>

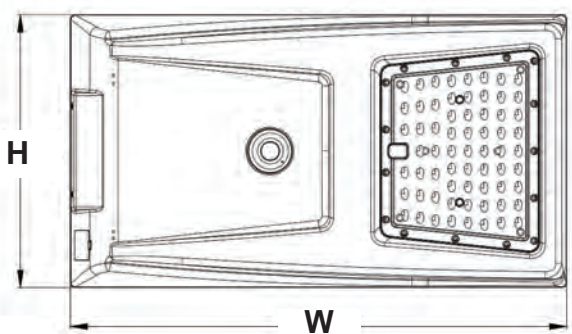

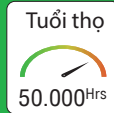
**New****DIALux**  
German Technology

### ĐẶC ĐIỂM KỸ THUẬT:

- Sử dụng 100% nguồn điện từ năng lượng mặt trời
- Thân làm bằng chất liệu nhôm nguyên khối cao cấp chống oxy hóa
- Hiệu suất sáng cao: 160 Lm/W
- Cấp bảo vệ IP65 chống nước
- Tản nhiệt tốt, tuổi thọ cao: 50.000 giờ
- Bền, nhẹ, khó vỡ, chịu lực, chịu nhiệt cao
- Khả năng chống sét
- Sử dụng đèn LED thay thế đèn truyền thống

### ỨNG DỤNG

- Chiếu sáng đèn sân thể thao, sân vườn, đường phố, giao thông công cộng, bệnh viện, trường học...

# LED Đường Đi NLMT Seri LSS2



Seri LSS2	Mã hàng Model	Quang thông Lumens	Nhiệt độ màu CCT	Kích thước WxHxL(mm)	Đóng gói Package	Đơn giá (VNĐ)
	LSS2-10T LSS2-10V LSS2-10N	1700Lm	6000 - 6500K 2800 - 3200K 4000 - 4500K	567x306x276mm	1 cái/thùng	10.279.500
	LSS2-20T LSS2-20V LSS2-20N	3400Lm	6000 - 6500K 2800 - 3200K 4000 - 4500K	741x306x276mm	1 cái/thùng	13.040.500
	LSS2-30T LSS2-30V LSS2-30N	5100Lm	6000 - 6500K 2800 - 3200K 4000 - 4500K	926x306x276mm	1 cái/thùng	16.847.600
	LSS2-40T LSS2-40V LSS2-40N	7200Lm	6000 - 6500K 2800 - 3200K 4000 - 4500K	1130x306x276mm	1 cái/thùng	20.845.000
	LSS2-50T LSS2-50V LSS2-50N	8500Lm	6000 - 6500K 2800 - 3200K 4000 - 4500K	1304x306x276mm	1 cái/thùng	22.843.700

Phụ kiện Seri LSS2	Mã hàng Model	Đơn giá (VNĐ)
	<b>EWM/LSS2</b> Giá đỡ cho đèn LSS2	1.427.800

Phụ kiện Seri LSS2	Mã hàng Model	Đơn giá (VNĐ)
	<b>CHA/LSS2</b> Nguồn điện cho đèn LSS2	898.700

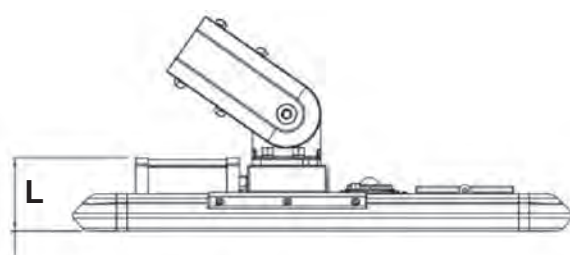
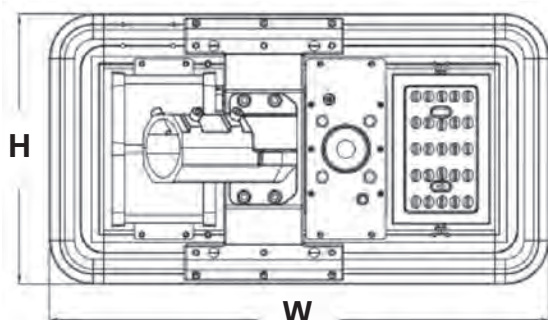



**New**

## DIALux

German Technology



### ĐẶC ĐIỂM KỸ THUẬT:

- Sử dụng 100% nguồn điện từ năng lượng mặt trời
- Thân làm bằng chất liệu nhôm nguyên khối cao cấp chống oxy hóa
- Kính cường lực, trong suốt giúp phân bổ ánh sáng đều, bảo vệ chip LED

- Cấp bảo vệ IP65 chống nước
- Tản nhiệt tốt, tuổi thọ cao: 50.000 giờ
- Bền, nhẹ, khó vỡ, chịu lực, chịu nhiệt cao
- Khả năng chống sét
- Sử dụng đèn LED thay thế đèn truyền thống

### ỨNG DỤNG

- Chiếu sáng đèn sân thể thao, sân vườn, đường phố, giao thông công cộng, bệnh viện, trường học...

### Seri LSS3



Mã hàng Model	Quang thông Lumens	Nhiệt độ màu CCT	Kích thước WxHxL(mm)	Đóng gói Package	Đơn giá (VNĐ)
LSS3-60T LSS3-60V LSS3-60N	8400Lm	6000 - 6500K 2800 - 3200K 4000 - 4500K	602x251x95mm	1 cái/thùng	<b>29.590.000</b>

## LED Thoát Hiểm

### LED thoát hiểm đa năng Seri EXM

	Mã hàng Model	Điện áp Voltage	Thời gian sạc Charge time	Thời gian sử dụng Emergency duration	Đơn giá (VNĐ)
	EX/M (Đèn báo Exit 1 mặt)	220V - 50Hz	24 giờ	3 giờ	1.419.600
	EXR/M (Một mặt phải)	220V - 50Hz	24 giờ	3 giờ	1.419.600
	EXL/M (Một mặt trái)	220V - 50Hz	24 giờ	3 giờ	1.419.600
	EXLR/M (Một mặt trái & phải)	220V - 50Hz	24 giờ	3 giờ	1.419.600
	EX2/M (Hai mặt trái)	220V - 50Hz	24 giờ	3 giờ	1.465.800
	EX2LR/M (Hai mặt trái & phải)	220V - 50Hz	24 giờ	3 giờ	1.465.800

### Phụ Kiện Thoát Hiểm Đa Năng Seri EXM





### LED thoát hiểm Seri EX

	Mã hàng Model	Điện áp Voltage	Thời gian sạc Charge time	Thời gian sử dụng Emergency duration	Đơn giá (VNĐ)
	EX (Đèn báo Exit 1 mặt)	220V - 50Hz	24 giờ	3 giờ	1.419.600
	EXR (Một mặt phải)	220V - 50Hz	24 giờ	3 giờ	1.419.600
	EXL (Một mặt trái)	220V - 50Hz	24 giờ	3 giờ	1.419.600
	EXLR (Một mặt trái & phải)	220V - 50Hz	24 giờ	3 giờ	1.419.600
	EX2 (Hai mặt trái)	220V - 50Hz	24 giờ	3 giờ	1.465.800
	EX2LR (Hai mặt trái & phải)	220V - 50Hz	24 giờ	3 giờ	1.465.800

### Phụ Kiện Thoát Hiểm Seri EX



LED chiếu sáng khẩn cấp	Mã hàng Model	Điện áp Voltage	Thời gian sạc Charge time	Thời gian sử dụng Emergency duration	Đóng gói Package	Đơn giá (VNĐ)
 <b>6W</b>	EML	220V - 50Hz	20 giờ	3 giờ	1 cái/hộp 6 cái/thùng	<b>1.116.900</b>
 <b>2x3W</b>	EML2	220V - 50Hz	20 giờ	3 giờ	1 cái/hộp 5 cái/thùng	<b>866.800</b>

LED bulb tích điện	Mã hàng Model	Quang thông Lumens	Góc chiếu Angle	Kích thước Size	Đóng gói Package	Đơn giá (VNĐ)
 <b>10W</b>	LB10T/E	1000 lm	230°	Ø68x145mm	1 cái/hộp 100 cái/thùng	<b>265.700</b>
 <b>12W</b>	LB12T/E	1200 lm	230°	Ø78x158mm	1 cái/hộp 100 cái/thùng	<b>288.800</b>

LED downlight âm trần khẩn cấp	Mã hàng Model	Thời gian khẩn cấp	Đục lỗ Cut out	Kích thước Size	Đóng gói Package	Đơn giá (VNĐ)
 <b>3W</b>	EM-AT	2 giờ	Ø60mm	Ø140mm	1 cái/hộp 100 cái/thùng	<b>1.239.900</b>

LED downlight gắn nổi khẩn cấp	Mã hàng Model	Thời gian khẩn cấp	Kích thước Size	Đóng gói Package	Đơn giá (VNĐ)
 <b>3W</b>	EM-NT	2 giờ	215x215x42	1 cái/hộp 100 cái/thùng	<b>1.609.000</b>

Bộ nguồn khẩn cấp	Mã hàng Model	Thời gian khẩn cấp	Diễn giải	Đóng gói Package	Đơn giá (VNĐ)
 <b>20W</b>	EM-LT	3 giờ	Sử dụng cho : LED Tube, Bulb, Panel, Downlight Công suất tối đa 20W dung lượng Pin 4000mAHx2	1 cái/hộp 100 cái/thùng	<b>2.348.200</b>

## ĐÈN BÀN 3 CHẾ ĐỘ - TL5



- LED chip tuổi thọ cao
- Chất liệu đèn cao cấp, độ bền cao
- Đèn 1 chế độ màu: trung tính
- Điều chỉnh được độ sáng nhiều mức phù hợp
- Kiểu dáng đẹp, hiện đại
- Không phát tia UV, không gây hại mắt
- Đèn được tích hợp để sạc không dây 10W
- Tổng công suất: 24W - 100-240V/50Hz
- Kích thước: 359 x 420 mm

	Mã hàng Model	Công suất Watt	Quang thông Lumens	Nhiệt độ màu CCT	Điện áp VAC	Đóng gói Package	Đơn giá (VNĐ)
	TL5	24W	420Lm	4000-4500K	100-240VAC	1 cái/hộp 12 cái/thùng	<b>1.061.500</b>





## ĐÈN BÀN TÍCH HỢP QUẠT + SẠC USB - TL6



- Số lượng LED: 60 con
- Nút điều khiển cảm ứng chuyển đổi
- Đèn 3 chế độ màu: trắng, vàng, trung tính
- 2 tốc độ quạt không cánh
- Tính năng hẹn giờ tắt (đếm ngược 40 phút)
- Tính năng lọc không khí
- Đế đèn có đèn LED chuyển màu RGB
- 2 đầu ra sạc USB: 5V 2.4A, 5V 1A
- Kích thước: 382 x 100 x 415 mm

	Mã hàng Model	Công suất Watt	Quang thông Lumens	Nhiệt độ màu CCT	Điện áp VAC	Đóng gói Package	Đơn giá (VNĐ)
	TL6	5W	270Lm	6500K 3000K 4000K	220VAC	1 cái/hộp 6 cái/thùng	<b>1.848.000</b>

## Đèn bàn + đèn Pin đa năng

Đèn bàn	Mã hàng Model	Công suất Watt	Quang thông Lumens	Nhiệt độ màu CCT	Điện áp VAC	Đóng gói Package	Đơn giá (VNĐ)
	TL1S	2.2W	150Lm	6500K 3000K 4000K	220VAC	1 cái/hộp 50 cái/thùng	<b>852.400</b>
	TL1G	2.2W	150Lm	6500K 3000K 4000K	220VAC	1 cái/hộp 50 cái/thùng	<b>852.400</b>
	TL2	6W	300Lm	6500K 3000K 4000K	220VAC	1 cái/hộp 8 cái/thùng	<b>651.400</b>
	TL3	4W	220Lm	6500K 3000K 4000K	220VAC	1 cái/hộp 16 cái/thùng	<b>449.400</b>
	LDL1	1.8W	270Lm	4000K	220VAC	1 cái/hộp 40 cái/thùng	<b>455.000</b>

Đèn Pin đa năng + USB	Mã hàng Model	Công suất Watt	Dung lượng Pin	Nhiệt độ màu CCT	Kích thước Size	Đóng gói Package	Đơn giá (VNĐ)
	DPM1	3W/6W	4000mAh	6500K	Ø150x235 mm	1 cái/hộp 20 cái/thùng	<b>518.100</b>
<ul style="list-style-type: none"> <li>- Đầu ra nguồn USB 5V - 0.5A</li> <li>- 3 bóng 6W trên thân đèn và 1 đèn soi 3W mặt trước</li> <li>- Có quai cầm và móc treo thuận tiện khi sử dụng</li> </ul>							



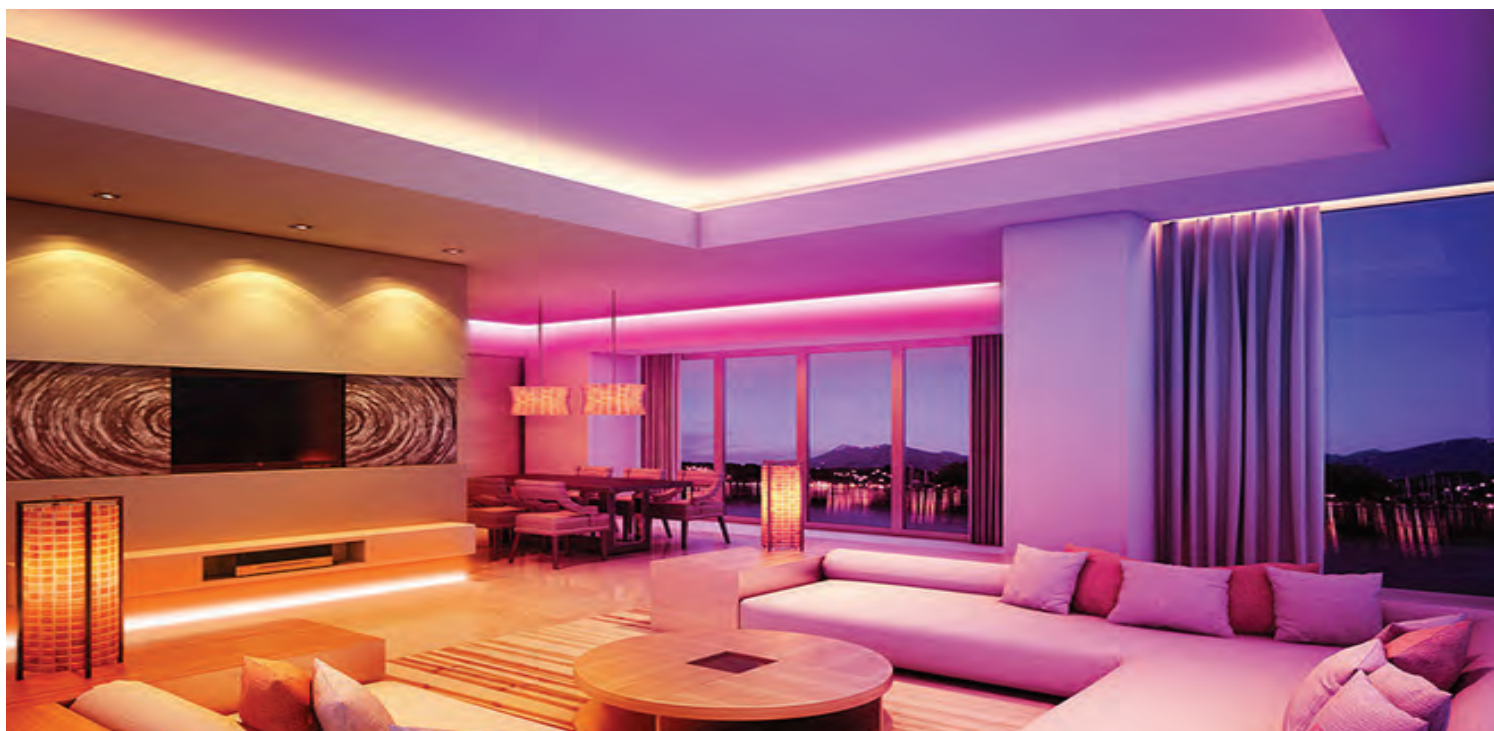

LED Dây AC 5050	Mã số / Diễn giải	Đơn giá (VNĐ)	LED Dây AC 2835	Mã số / Diễn giải	Đơn giá (VNĐ)
	<b>LS2 5050AC-T</b> <b>LS2 5050AC-V</b> LED Dây AC 5050 - Công suất: 7W/m - Lumens : 400Lm/m - Chiều dài: 50m/cuộn - 72LED/m - KT: 12.3x6.5mm - IP 65	95.900/m		<b>LS2 2835AC-T</b> <b>LS2 2835AC-V</b> LED Dây AC 2835 - Công suất: 9W/m - Lumens : 750Lm/m - Chiều dài: 50m/cuộn - 180LED/m - KT: 14x7mm - IP 65	121.300/m
	<b>MC2-LS5050AC</b> Khớp nối giữa LED Dây 5050AC	18.400		<b>MC2-LS2835AC</b> Khớp nối giữa LED Dây 2835AC	19.400
	<b>BCL2 5050-AC</b> Power cord 5050 - AC - Bộ chỉnh lưu LED dây 5050 - AC	91.300		<b>BCL2 2835-AC</b> Power cord 2835 - AC - Bộ chỉnh lưu LED dây 2835 - AC	91.300
	<b>KLS2 AC-5050</b> Kẹp cho LED dây AC 5050	9.200		<b>KLS2 AC-2835</b> Kẹp cho LED dây AC 2835	9.200
LED Dây AC	Mã số / Diễn giải	Đơn giá (VNĐ)	Phụ kiện LED Dây	Mã số / Diễn giải	Đơn giá (VNĐ)
	<b>LS2835/90-RGB/AC</b> LED Dây AC - RGB - Công suất: 9W/m - 90LED/m - Chiều dài: 50m/cuộn - KT: 16x8mm - IP 65	159.000/m		<b>RF-2835RGB</b> Driver + remote RF - Khoảng cách điều khiển : 5-20m - Điện áp: 220V - Remote: <5m - IP 20 - Công suất: 400W	629.800

LED Dây AC	Mã số / Diễn giải	Đơn giá(VNĐ)	Phụ kiện LED Dây AC	Mã số / Diễn giải	Đơn giá(VNĐ)
	<b>LS5050AC-T</b> <b>LS5050AC-V</b> LED Dây AC 5050 - Công suất: 8W/1m - Lumens : 300Lm/m - Chiều dài: 50m/cuộn - 60 LED/m - KT: 14x7.3mm - IP 65	<b>95.900/m</b>		<b>BCL5050-AC</b> Power cord 5050 - AC - Bộ chỉnh lưu LED dây 5050 - AC	<b>91.300</b>
	<b>MC-LS5050AC</b> Khớp nối giữa LED Dây 5050AC	<b>18.400</b>		<b>BCL2835-AC</b> Power cord 2835-AC - Bộ chỉnh lưu LED dây 2835-AC	<b>91.300</b>
	<b>LS2835AC-T</b> <b>LS2835AC-V</b> LED Dây AC2835 - Công suất: 8W/1m - Lumens : 700Lm/m - Chiều dài: 50m/cuộn - 120 LED/m - KT: 18x8mm - IP 65	<b>121.300/m</b>		<b>KLSAC - 2835</b> Kẹp cho LED dây AC 2835	<b>9.200</b>
	<b>MC-LS2835AC</b> Khớp nối giữa LED Dây 2835AC	<b>19.400</b>		<b>KLSAC - 5050</b> Kẹp cho LED dây AC 5050	<b>9.200</b>

LED Dây DC	Mã số / Diễn giải	Đơn giá(VNĐ)	Phụ kiện LED Dây DC	Mã số / Diễn giải	Đơn giá(VNĐ)
	<b>LS2835DC-T</b> <b>LS2835DC-V</b> LED Dây DC2835 - Công suất: 9W/m - chiều dài: 5m/cuộn - Điện áp: 12V - IP 44	<b>130.600/m</b>		<b>DLS-60</b> Driver LED Dây DC - Điện áp vào 220V - Điện áp ra: 12V - Công suất 60W - IP 20	<b>502.500</b>

LED Dây Neon AC	Mã số / Diễn giải	Đơn giá(VNĐ)	Phụ kiện LED Dây Neon AC	Mã số / Diễn giải	Đơn giá(VNĐ)
	<b>LSN2-RGB</b> LED Dây Neon - Công suất: 8W/m - Chiều dài: 25m/cuộn - KT: 11x22mm - IP 65	<b>302.600/m</b>		<b>CLSN2</b> Bộ Nguồn Dây LED Neon - Điện áp: 220V - Remote: <5m - IP 20 - Công suất: 1000W	<b>404.300</b>
	<b>MC-LSN2</b> Khớp nối giữa LED Dây Neon AC	<b>28.600</b>		<b>KLSN2</b> Kẹp cho LED Dây Neon	<b>18.500</b>

## LED dây/ Máng đèn (không bao gồm bóng)

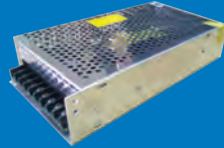

LED Dây	Mã số / Diễn giải	Đơn giá(VNĐ)
	<b>LSWH</b> LED dây hắt trần màu trắng, 6500K 14,4w/m, 12V DC - Chip SMD 50x50 - 60 LED /m - Có phủ keo, IP65	<b>130.600/m</b>
	<b>LSWW</b> LED dây hắt trần màu vàng, 2800K 14,4w/m, 12V DC - Chip SMD 50x50 - 60 LED /m - Có phủ keo, IP65	<b>130.600/m</b>

Driver LED Dây	Mã số / Diễn giải	Đơn giá(VNĐ)
	<b>DLR-75W</b> Driver LED dây Công suất: 75W Điện áp: 12V	<b>502.500</b>

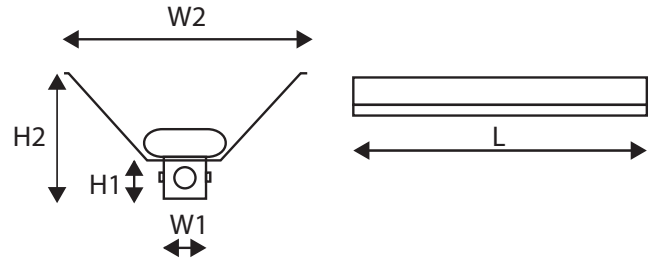
Máng Đèn Công Nghiệp	Mã số / Diễn giải	Đơn giá(VNĐ)
	<b>MCN-120</b> Máng đèn công nghiệp đơn 1.2m, chứa sơn tĩnh điện	<b>241.500</b>
	<b>MCN-220</b> Máng đèn công nghiệp đôi 1.2m, chứa sơn tĩnh điện	<b>264.600</b>





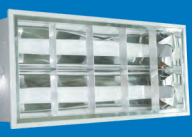
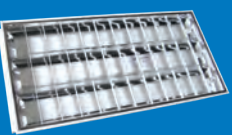

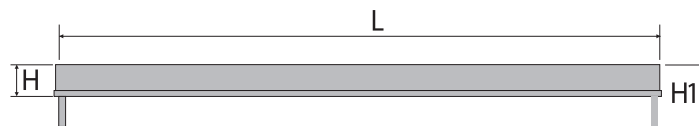

Mã hàng	Đóng gói	L	W1	W2	H1	H2
MCN-120	12 cái/thùng	1230	170	50	35	75
MCN-220	12 cái/thùng	1230	182	50	35	75

	Mã hàng Model	Diễn giải	Kích thước WxLxH	Đóng gói Package	Đơn giá (VNĐ)
	<b>MWP 118</b>	Máng đèn chống thấm (không bao gồm bóng) 0,6m đơn	660x86x90mm	15 cái/thùng	<b>418.100</b>
	<b>MWP 136</b>	Máng đèn chống thấm (không bao gồm bóng) 1.2m đơn	1270x86x90mm	9 cái/thùng	<b>639.900</b>
	<b>MWP 218</b>	Máng đèn chống thấm (không bao gồm bóng) 0,6m đôi	660x136x90mm	10 cái/thùng	<b>556.700</b>
	<b>MWP 236</b>	Máng đèn chống thấm (không bao gồm bóng) 1.2m đôi	1270x136x90mm	6 cái/thùng	<b>843.200</b>
	<b>MAT 218</b>	Máng đèn xương cá âm trần 2 bóng 0.6m (không bao gồm bóng)	605x300x83mm	2 cái/thùng	<b>537.100</b>
	<b>MAT 236</b>	Máng đèn xương cá âm trần 2 bóng 1.2m (không bao gồm bóng)	1215x300x83mm		<b>927.500</b>
	<b>MAT 318</b>	Máng đèn xương cá âm trần 3 bóng 0.6m (không bao gồm bóng)	605x600x83mm		<b>866.300</b>
	<b>MAT 336</b>	Máng đèn xương cá âm trần 3 bóng 1.2m (không bao gồm bóng)	1215x600x83mm		<b>1.466.900</b>

## Máng đèn batten/ Phụ kiện (không bao gồm bóng)

Máng đèn Batten	Mã hàng Model	Diễn giải	Kích thước LxHxH1xL1 mm	Đóng gói Package	Đơn giá (VNĐ)
	<b>MBT 118</b>	Máng đèn 1 bóng 0.6m (tăng phô + chuột)	595x24x60x45 mm	1 cái/hộp 12 cây/thùng	<b>150.200</b>
	<b>MBT 118/BL</b>	Máng đèn 1 bóng 0.6m (tăng phô + chuột) chân màu xanh dương			
	<b>EBT 118</b>	Máng đèn 1 bóng, siêu mỏng 0.6m ballast điện tử (tăng phô + chuột)			
	<b>EBT 118/BL</b>	Máng đèn 1 bóng, siêu mỏng 0.6m ballast điện tử (tăng phô + chuột) chân màu xanh dương			
	<b>MBT 136</b>	Máng đèn 1 bóng 1.2m (tăng phô + chuột)	1200x24x60x45 mm	1 cái/hộp 12 cây/thùng	<b>161.700</b>
	<b>MBT 136/BL</b>	Máng đèn 1 bóng 1.2m (tăng phô + chuột) chân màu xanh dương			
	<b>EBT 136</b>	Máng đèn 1 bóng, siêu mỏng 1.2m ballast điện tử (tăng phô + chuột)			
	<b>EBT 136/BL</b>	Máng đèn 1 bóng, siêu mỏng 1.2m ballast điện tử (tăng phô + chuột) chân màu xanh dương			
	<b>MBT 236</b>	Máng đèn 2 bóng 1.2m (tăng phô + chuột)	1200x24x60x45 mm	1 cái/hộp 12 cây/thùng	<b>265.700</b>
	<b>MBT 236/BL</b>	Máng đèn 2 bóng 1.2m (tăng phô + chuột) chân màu xanh dương			
	<b>EBT 236</b>	Máng đèn 2 bóng, siêu mỏng 1.2m ballast điện tử (tăng phô + chuột)			
	<b>EBT 236/BL</b>	Máng đèn 2 bóng, siêu mỏng 1.2m ballast điện tử (tăng phô + chuột) chân màu xanh dương			



Phụ Kiện Batten	Mã số / Diễn giải	Đơn giá (VNĐ)	Phụ Kiện Batten	Mã số / Diễn giải	Đơn giá (VNĐ)	
	<b>MS</b> Con mỗi Starer	<b>5.600</b>		<b>EBL-18</b> Ballast điện tử 18W Electronic Ballast 18W	<b>76.200</b>	
	<b>BL-18</b> Chấn lưu 18W Ballasts 18W	<b>83.200</b>			<b>EBL-36</b> Ballast điện tử 36W Electronic Ballast 36W	<b>76.200</b>
	<b>BL-36</b> Chấn lưu 36W Ballasts 36W	<b>83.200</b>				

# CÔNG TẮC & Ổ CẮM / Switch & Socket



Series A50



Series A60

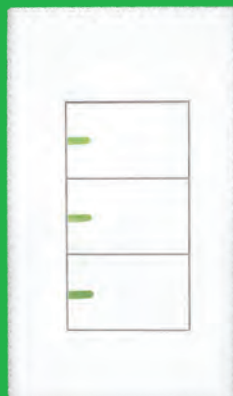

Series A70 Plus

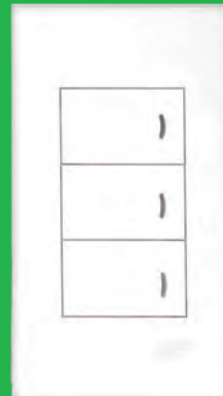

Series A80

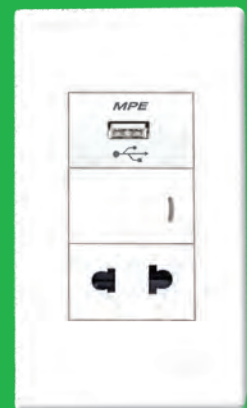

- Sản xuất từ nhựa PC chống cháy
- Ổ cắm đa năng dùng cho các loại phích cắm
- Có màng che bảo vệ
- Module USB sạc được tất cả thiết bị Iphone, Ipad...

Series A90



Series A20 Plus



Series S60

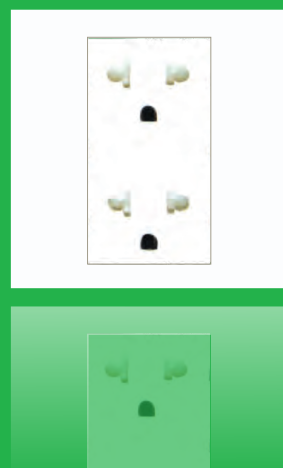





Series S70



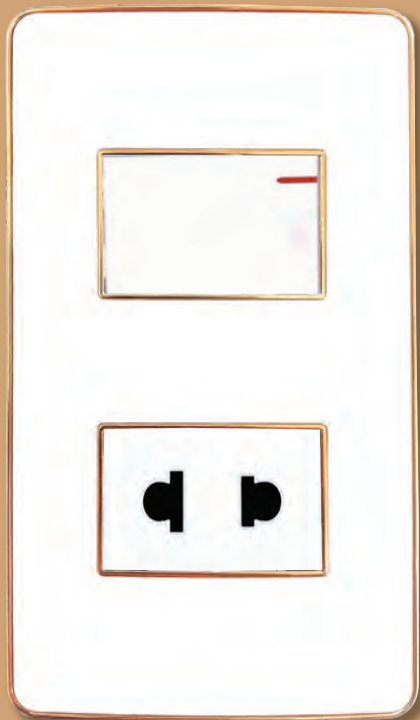



# Seri A60 Viền màu









New













	Mã số / Diễn giải	Đơn giá (VNĐ)
	<b>A601G</b> Mặt dùng cho 1 thiết bị viền vàng KT: 120x70mm	<b>35.700</b>
	<b>A602G</b> Mặt dùng cho 2 thiết bị viền vàng KT: 120x70mm	<b>35.700</b>
	<b>A603G</b> Mặt dùng cho 3 thiết bị viền vàng KT: 120x70mm	<b>35.700</b>
	<b>A60SBG</b> Mặt dùng cho SB viền vàng KT: 120x70mm	<b>41.600</b>

















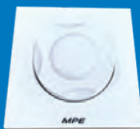

	Mã số / Diễn giải	Đơn giá (VNĐ)
	<b>A601S</b> Mặt dùng cho 1 thiết bị viền bạc KT: 120x70mm	<b>35.700</b>
	<b>A602S</b> Mặt dùng cho 2 thiết bị viền bạc KT: 120x70mm	<b>35.700</b>
	<b>A603S</b> Mặt dùng cho 3 thiết bị viền bạc KT: 120x70mm	<b>35.700</b>
	<b>A60SBS</b> Mặt dùng cho SB viền bạc KT: 120x70mm	<b>41.600</b>

## Mặt công tắc & ổ cắm series A60, S60, A50

	Mã số / Diễn giải	Đơn giá (VNĐ)
	<b>A601</b> Mặt dùng cho 1 thiết bị KT: 120x70mm	16.900
	<b>A602</b> Mặt dùng cho 2 thiết bị KT: 120x70mm	16.900
	<b>A620</b> Mặt dùng cho 2 thiết bị KT: 120x70mm	16.900
	<b>A603</b> Mặt dùng cho 3 thiết bị KT: 120x70mm	16.900
	<b>A60456</b> Mặt dùng cho 4,5,6 thiết bị KT: 120x116mm	30.500
	<b>A6SB</b> Module rời lắp SB	6.500
	<b>A60SB</b> Mặt dùng cho cầu dao an toàn KT: 120x70mm	19.400
	<b>A60MCB1</b> Mặt dùng cho MCB 1 cực KT: 120x70mm	19.400
	<b>A60MCB2</b> Mặt dùng cho MCB 2 cực KT: 120x70mm	19.400

	Mã số / Diễn giải	Đơn giá (VNĐ)
	<b>S601</b> Mặt vuông dùng cho 1 thiết bị KT: 86x86mm	19.700
	<b>S615</b> Mặt vuông dùng cho 1 thiết bị cỡ trung KT: 86x86mm	19.700
	<b>S602</b> Mặt vuông dùng cho 2 thiết bị KT: 86x86mm	19.700
	<b>S603</b> Mặt vuông dùng cho 3 thiết bị KT: 86x86mm	19.700
	<b>A501</b> Mặt dùng cho 1 thiết bị KT: 120x70mm	16.900
	<b>A502</b> Mặt dùng cho 2 thiết bị KT: 120x70mm	16.900
	<b>A503</b> Mặt dùng cho 3 thiết bị KT: 120x70mm	16.900
	<b>A50456</b> Mặt dùng cho 4,5,6 thiết bị KT: 120x116mm	30.500
	<b>A50SB</b> Mặt dùng cho cầu dao an toàn KT: 120x70mm	19.400
	<b>A50MCB1</b> Mặt dùng cho MCB 1 cực KT: 120x70mm	19.400
	<b>A50MCB2</b> Mặt dùng cho MCB 2 cực KT: 120x70mm	19.400











## Thiết bị rời series A60, S60, A50

	Mã số / Diễn giải	Đơn giá (VNĐ)		Mã số / Diễn giải	Đơn giá (VNĐ)
	<b>A6USB-A/C</b> Ổ cắm sạc USB type A & type C DC 5V-2.1A	482.800		<b>A6RJ64</b> Ổ cắm điện thoại 4 dây	73.700
	<b>A6USB</b> Ổ cắm sạc USB DC 5V-2.1A	306.100		<b>A6RJ88</b> Ổ cắm mạng LAN 8 dây	144.900
	<b>A6US</b> Ổ cắm 2 chấu	32.400		<b>A6MBP</b> Nút nhấn chuông 3A	42.400
	<b>A6UES2</b> Ổ cắm đôi 3 chấu	81.800		<b>A6F</b> Cầu chì	22.900
	<b>A6UESM</b> Ổ cắm đa năng 1.5 module	68.200		<b>A6V200-LED</b> Dimmer điều chỉnh độ sáng LED (dùng cho LED Dimmable) Điện áp: 220VAC Công suất: 200W	698.800
	<b>A6M/1</b> Công tắc 1 chiều	20.300		<b>ASV200-LED</b> Dimmer điều chỉnh độ sáng LED (dùng cho LED Dimmable) Điện áp: 220VAC Công suất: 200W	914.800
	<b>A6M/2</b> Công tắc 2 chiều	33.900		<b>A6V800F</b> Bộ điều chỉnh tốc độ quạt 800VA-220VAC	107.600
	<b>A6NGN</b> Đèn báo xanh seri A60	38.800		<b>A6V800L</b> Bộ điều chỉnh độ sáng đèn 800W-220VAC	118.600
	<b>A6NRD</b> Đèn báo đỏ seri A60	38.800		<b>A6V1200L</b> Bộ điều chỉnh độ sáng đèn 1.200W-220VAC	131.900
	<b>A6TV75</b> Ổ cắm đồng trục TV loại 75 Ohm	73.700		<b>A6MD20</b> Công tắc 2 cực 20A	89.900



## Thiết bị rời vận vít series A50, A60, S60

	Mã số / Diễn giải	Đơn giá (VNĐ)
	<b>A6USV (Vận vít)</b> Ổ cắm 2 chấu	32.400
	<b>A6M/1V (Vận vít)</b> Công tắc 1 chiều	20.300
	<b>A6M/2V (Vận vít)</b> Công tắc 2 chiều	33.900
	<b>A6M/1M (Vận vít)</b> Công tắc 1 chiều cỡ trung	40.400
	<b>A6M/2M (Vận vít)</b> Công tắc 2 chiều cỡ trung	72.600
	<b>A6M/1L (Vận vít)</b> Công tắc 1 chiều cỡ lớn	40.400
	<b>A6M/2L (Vận vít)</b> Công tắc 2 chiều cỡ lớn	72.600
	<b>A6P2</b> Nút che trơn 1.5 module	5.100
	<b>A6P</b> Nút che trơn 1 module	5.100

	Mã số / Diễn giải	Đơn giá (VNĐ)
	<b>A6UESM-2 (Vận vít)</b> Ổ cắm đa năng A60 2 module	68.200
	<b>A6UESMV (Vận vít)</b> Ổ cắm đa năng A60 1.5 module	68.200
	<b>A6NGNV</b> Đèn báo xanh	38.800
	<b>A6NRDV</b> Đèn báo đỏ	38.800
	<b>A6DDI</b> Đèn báo dừng làm phiền	90.800
	<b>A6CLR</b> Đèn báo dọn phòng	90.800
	<b>DBP</b> Nút nhấn chuông KT: 118x72x28mm	118.300
	<b>DB</b> Chuông điện KT: 163x98x40mm	193.300
	<b>A267BP</b> Nút ấn chuông KT: 120x70mm IP44	118.300
	<b>DB2</b> Chuông cửa không dây, không pin - 32 âm tùy chọn - 4 mức âm lượng - Tần số: 433Mhz	756.000



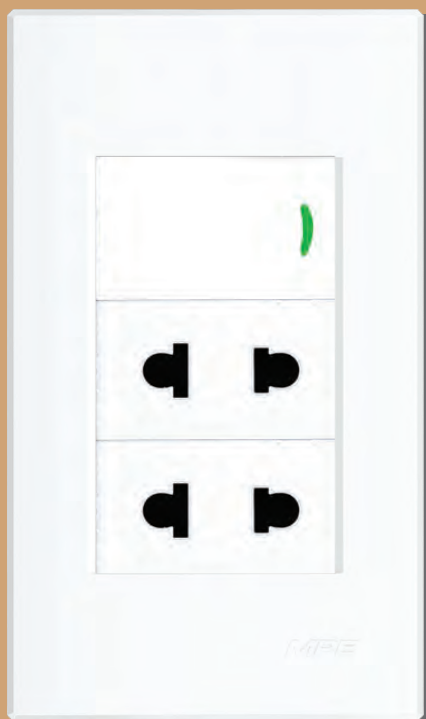













# Seri A70 Plus





















- Tiêu chuẩn IEC-60884-1
- Nhựa PC được sử dụng cho sản phẩm mang lại độ chống trầy xước lớn.
- Khả năng chống va đập, chịu nhiệt tốt, chống ăn mòn hiệu quả.
- Bề mặt cong, bóng tạo nét thẩm mỹ cao
- Lò xo trợ lực hạn chế phát sinh tia lửa điện rất an toàn cho người sử dụng nhất là đối với các gia đình có trẻ nhỏ.
- Vít đồng tròn tăng lực siết và không làm đứt dây.
- Thiết kế nhỏ gọn, hình chữ nhật mỏng ôm sát bề mặt tường lắp đặt



## Mặt công tắc, ổ cắm, thiết bị rời series A70 Plus















	Mã số / Diễn giải	Đơn giá (VNĐ)		Mã số / Diễn giải	Đơn giá (VNĐ)
	<b>A701N</b> Mặt dùng cho 1 thiết bị KT: 120x70mm	16.900		<b>A7M/1</b> Công tắc 1 chiều	20.300
	<b>A702N</b> Mặt dùng cho 2 thiết bị KT: 120x70mm	16.900		<b>A7M/2</b> Công tắc 2 chiều	33.900
	<b>A703N</b> Mặt dùng cho 3 thiết bị KT: 120x70mm	16.900		<b>A7MD20</b> Công tắc 2 cực 20A	89.900
	<b>A70456N</b> Mặt dùng cho 4,5,6 thiết bị KT: 120x115mm	30.500		<b>A7MBP</b> Nút nhấn chuông	42.400
	<b>A70SB</b> Mặt dùng cho cầu dao an toàn	19.400		<b>A7US</b> Ổ cắm 2 chấu	32.400
	<b>A70MCB1</b> Mặt dùng cho MCB 1 cực	19.400		<b>A7UESM</b> Ổ cắm đa năng 2 module	68.200
	<b>A70MCB2</b> Mặt dùng cho MCB 2 cực	19.400		<b>A7UES2</b> Ổ cắm đôi 3 chấu	81.800
	<b>A70KT</b> Bộ công tắc dùng thẻ từ 25A có thời gian chậm	451.100		<b>KT</b> Thẻ từ (dùng cho BKT, A70KT)	52.100

## Mặt công tắc, ổ cắm, thiết bị rời series A70 Plus

	Mã số / Diễn giải	Đơn giá (VNĐ)		Mã số / Diễn giải	Đơn giá (VNĐ)
	<b>A7TV75</b> Ổ cắm Tivi	73.700		<b>A7USB-A/C</b> Ổ cắm sạc USB type A & type C DC 5V-2.1A	482.800
	<b>A7RJ64</b> Ổ cắm Điện thoại	73.700		<b>DB</b> Chuông điện KT: 163x98x40mm	193.200
	<b>A7RJ88</b> Ổ cắm mạng Lan	144.900		<b>DBP</b> Nút nhấn chuông KT: 118x72x28mm	118.300
	<b>A7NRD</b> Đèn báo đỏ	38.800		<b>A267BP</b> Nút ấn chuông Kt: 120x70mm IP44	118.300
	<b>A7NGN</b> Đèn báo xanh	38.800		<b>DB2</b> Chuông cửa không dây, không pin - 32 âm tùy chọn - 4 mức âm lượng - Tần số: 433Mhz	756.000
	<b>A800F</b> Bộ điều chỉnh tốc độ quạt 800VA-220VAC	107.600		<b>A7CLR</b> Đèn báo dọn phòng	90.800
	<b>A800L</b> Bộ điều chỉnh độ sáng đèn 800W-220VAC	118.600		<b>A7DDI</b> Đèn báo dừng làm phiền	90.800
	<b>A1200L</b> Bộ điều chỉnh độ sáng đèn 1.200W-220VAC	131.900		<b>A78F</b> Cầu chì 10A	22.900
	<b>A7USB</b> Ổ cắm sạc USB	306.100		<b>FS</b> Cầu chì 10A	6.500
				<b>A7P</b> Nút che trơn 1 module	5.100

## Mặt công tắc & ổ cắm series A80, A90

### Thiết bị rời dùng chung với series A70 Plus



	Mã số / Diễn giải	Đơn giá (VNĐ)		Mã số / Diễn giải	Đơn giá (VNĐ)
	<b>A801</b> Mặt dùng cho 1 thiết bị KT: 120x70mm	16.900		<b>A901</b> Mặt dùng cho 1 thiết bị KT: 120x70mm	16.900
	<b>A802</b> Mặt dùng cho 2 thiết bị KT: 120x70mm	16.900		<b>A902</b> Mặt dùng cho 2 thiết bị KT: 120x70mm	16.900
	<b>A803</b> Mặt dùng cho 3 thiết bị KT: 120x70mm	16.900		<b>A903</b> Mặt dùng cho 3 thiết bị KT: 120x70mm	16.900
	<b>A80456</b> Mặt dùng cho 4,5,6 thiết bị KT: 120x116mm	30.500		<b>A90456</b> Mặt dùng cho 4,5,6 thiết bị KT: 120x116mm	30.500
	<b>A80SB</b> Mặt dùng cho cầu dao an toàn KT: 120x70mm	19.800		<b>A90SB</b> Mặt dùng cho cầu dao an toàn KT: 120x70mm	19.800
	<b>A80MCB1</b> Mặt dùng cho MCB 1 cực KT: 120x70mm	19.800		<b>A90MCB1</b> Mặt dùng cho MCB 1 cực KT: 120x70mm	19.800
	<b>A80MCB2</b> Mặt dùng cho MCB 2 cực KT: 120x70mm	19.800		<b>A90MCB2</b> Mặt dùng cho MCB 2 cực KT: 120x70mm	19.800

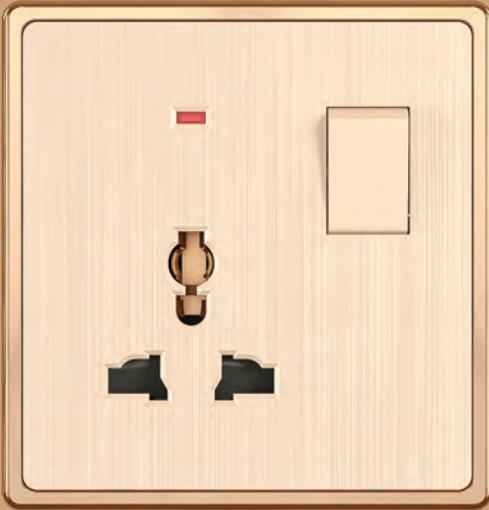

# Seri S70











- Tiêu chuẩn IEC-60884-1
  - Siêu đẹp, Siêu bền, Siêu an toàn.
  - Sang trọng để tôn thêm vẻ đẹp cho ngôi nhà bạn.
- Công tắc ổ cắm điện mặt Vuông theo phong cách hiện đại
- Sản xuất theo công nghệ Germany (Đức)
  - Mẫu mã đa dạng, màu sắc sang trọng và đẳng cấp, phù hợp với mọi không gian kiến trúc
  - Bật/ Tắt 50,000 lần với công tắc.
  - Cách lắp đặt dễ dàng









	Mã số / Diễn giải	Đơn giá (VNĐ)
	<b>S701</b> Mặt 1 công tắc 1 chiều 16A - 250V KT: 86x89mm	<b>110.600</b>
	<b>S701M</b> Mặt 1 công tắc 2 chiều 16A - 250V KT: 86x89mm	<b>116.900</b>
	<b>S702</b> Mặt 2 công tắc 1 chiều 16A - 250V KT: 86x89mm	<b>142.300</b>





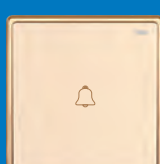

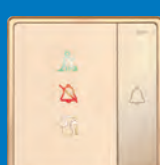





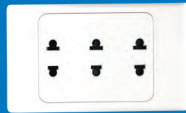



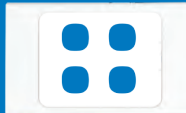

	Mã số / Diễn giải	Đơn giá (VNĐ)
	<b>S702M</b> Mặt 2 công tắc 2 chiều 16A - 250V KT: 86x89mm	<b>146.200</b>
	<b>S703</b> Mặt 3 công tắc 1 chiều 16A - 250V KT: 86x89mm	<b>153.800</b>
	<b>S704</b> Mặt 4 công tắc 1 chiều 16A - 250V KT: 86x89mm	<b>216.000</b>

## Mặt công tắc & ổ cắm series S70

	Mã số / Diễn giải	Đơn giá (VNĐ)
	<b>S7MS</b> Ổ cắm đa năng + công tắc 10A - 250V KT: 86x89mm	<b>139.800</b>
	<b>S7MS/USB</b> Ổ cắm đa năng + ổ cắm đơn 2 chấu + 2USB KT: 86x89mm	<b>433.300</b>
	<b>S7UES2</b> 2 ổ cắm 3 chấu KT: 86x89mm	<b>240.000</b>
	<b>S7TEL</b> Ổ cắm điện thoại KT: 86x89mm	<b>123.300</b>
	<b>S7LAN</b> Ổ cắm mạng Lan KT: 86x89mm	<b>177.900</b>
	<b>S7TEL/LAN</b> Ổ cắm điện thoại + mạng Lan KT: 86x89mm	<b>227.500</b>
	<b>S7TV/LAN</b> Ổ cắm Tivi + mạng Lan KT: 86x89mm	<b>227.500</b>
	<b>S7TV/TEL</b> Ổ cắm Tivi + điện thoại KT: 86x89mm	<b>227.500</b>



















	Mã số / Diễn giải	Đơn giá (VNĐ)
	<b>S7TV</b> Ổ cắm tivi KT: 86x89mm	<b>125.800</b>
	<b>S7LAN/2</b> 2 ổ cắm mạng Lan KT: 86x89mm	<b>277.000</b>
	<b>S7TEL/2</b> 2 ổ cắm điện thoại KT: 86x89mm	<b>197.000</b>
	<b>S7DIM/L</b> Dimmer điều chỉnh độ sáng đèn 400W KT: 86x89mm	<b>457.400</b>
	<b>S7DIM/F</b> Dimmer điều chỉnh tốc độ quạt 250W KT: 86x89mm	<b>457.400</b>
	<b>S7DBP</b> Nút nhấn chuông 6A - 250V KT: 86x89mm	<b>171.600</b>
	<b>S7MD20</b> Công tắc 2 cực 20A KT: 86x89mm	<b>304.900</b>
	<b>S7MS2</b> 2 ổ cắm đa năng + 2 công tắc 10A-250V KT: 145x89mm	<b>279.500</b>
	<b>S7CDP</b> Nút nhấn chuông + đèn báo không làm phiền + đèn báo dọn phòng KT: 86x89mm	<b>412.900</b>

## Mặt công tắc & ổ cắm series A20 Plus













	Mã số / Diễn giải	Đơn giá(VNĐ)		Mã số / Diễn giải	Đơn giá(VNĐ)
	<b>A20US2N</b> Ổ cắm đôi 2 chấu để liên 16A KT: 120x72mm	54.800		<b>A201N</b> Mặt 1 lỗ KT: 120x72mm	15.800
	<b>A20US3N</b> Ổ cắm 3, 2 chấu để liên 16A KT: 120x72mm	66.100		<b>A202N</b> Mặt 2 lỗ KT: 120x72mm	15.800
	<b>A20UES2N</b> Ổ cắm đôi 3 chấu để liên 16A KT: 120x72mm	68.600		<b>A203N</b> Mặt 3 lỗ KT: 120x72mm	15.800
	<b>A20UESM2N</b> Ổ cắm đôi đa năng để liên 16A KT: 120x72mm	68.600		<b>A204N</b> Mặt 4 lỗ KT: 120x72mm	20.400
	<b>A20US2MN</b> Ổ cắm đa năng Ổ cắm đơn 16A KT: 120x72mm	62.400		<b>A205N</b> Mặt 5 lỗ KT: 120x72mm	20.400
	<b>A20US2XN</b> Ổ cắm đôi 2 chấu 16A + 1 lỗ KT: 120x72mm	53.400		<b>A206N</b> Mặt 6 lỗ KT: 120x72mm	20.400
	<b>A20US2XXN</b> Ổ cắm đôi 2 chấu 16A + 2 lỗ KT: 120x72mm	53.400		<b>ASBN</b> Mặt dùng cho cầu dao an toàn KT: 120x72mm	17.400
	<b>A20USMXN</b> Ổ cắm đơn đa năng 16A + 1 lỗ KT: 120x72mm	46.100		<b>AMCB1N</b> Mặt dùng cho MCB 1 cực KT: 120x72mm	15.800
	<b>A20USMXXN</b> Ổ cắm đơn đa năng 16A + 2 lỗ KT: 120x72mm	46.100		<b>AMCB2N</b> Mặt dùng cho MCB 2 cực KT: 120x72mm	15.800
	<b>A20USMN</b> Ổ cắm đơn đa năng 16A KT: 120x72mm	46.100		<b>A201VXN</b> Mặt nạ trơn KT: 120x72mm	15.800



## Mặt công tắc & ổ cắm series B20

	Mã số / Diễn giải	Đơn giá (VNĐ)		Mã số / Diễn giải	Đơn giá (VNĐ)
	<b>B2US2</b> Mặt ổ cắm đôi 2 chấu KT: 86x86mm	63.600		<b>B201</b> Mặt đơn KT: 86x86mm	17.200
	<b>B215S</b> Mặt ổ cắm 3 chấu vuông + 1 công tắc KT: 86x86mm	119.800		<b>B202</b> Mặt đôi KT: 86x86mm	17.200
	<b>DB2</b> Chuông cửa không dây, không pin - 32 âm tùy chọn - 4 mức âm lượng - Tần số: 433Mhz	756.000		<b>B203</b> Mặt ba KT: 86x86mm	17.200
	<b>DBP</b> Nút nhấn chuông KT: 118x72x28mm	118.300		<b>B204</b> Mặt bốn KT: 86x86mm	24.200
	<b>DB</b> Chuông điện KT: 163x98x40mm	193.200		<b>B2UESM</b> Ổ cắm đa năng + 1 công tắc KT: 86x86mm	60.400
	<b>A267BP</b> Nút ấn chuông Kt: 120x70mm IP44	118.300		<b>B2US</b> Mặt ổ cắm đơn 2 chấu KT: 86x86mm	39.500
	<b>BKT</b> Bộ công tắc dùng thẻ tử 16A có thời gian chậm KT: 86x86mm	453.600		<b>B2USX</b> Mặt cắm đơn 2 chấu + 1 lỗ KT: 86x86mm	50.800
	<b>B727</b> Ổ cắm cạo râu 110/250V vuông 1.200W-220VAC KT: 86x86mm	893.200		<b>B2TDS</b> Công tắc cảm ứng có Delay KT: 86x86mm	648.000
	<b>A727</b> Ổ cắm cạo râu 110/250V thẳng đứng	893.200		<b>B2DDI</b> Mặt nạ hiển thị "đừng làm phiền" KT: 86x86mm	648.000











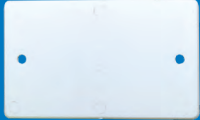





## Thiết bị rời dùng chung series A20 plus, series B20

	Mã số / Diễn giải	Đơn giá(VNĐ)		Mã số / Diễn giải	Đơn giá(VNĐ)
	<b>A20-IP</b> Mặt viền đơn màu trắng kiểu Iphone KT: 120x71.5mm	8.000		<b>DBP</b> Nút nhấn chuông KT: 118x72x28mm	118.300
	<b>A20-WND</b> Mặt viền đôi màu trắng KT: 120x142mm	15.300		<b>DB</b> Chuông điện KT: 163x98x40mm	193.200
	<b>A20-WN</b> Mặt viền đơn màu trắng KT: 120x71.5mm	8.000		<b>A267BP</b> Nút ấn chuông KT: 120x70mm IP44	118.300
	<b>A20-WE</b> Mặt viền đơn màu trắng KT: 115x75mm	8.000		<b>DB2</b> Chuông cửa không dây, không pin - 32 âm tùy chọn - 4 mức âm lượng - Tần số: 433Mhz	756.000
	<b>A30/1</b> Công tắc 1 chiều 10A	13.100		<b>A30RJ88</b> Ổ cắm mạng Lan 8 dây	79.100
	<b>A30M</b> Công tắc 2 chiều 10A	22.700		<b>A30RJ64</b> Ổ cắm điện thoại 4 dây	54.700
	<b>A30MD20</b> Công tắc 2 cực 20A	78.800		<b>A30TV75</b> Ổ cắm tivi loại 75 Ohm	49.600

## Thiết bị rời dùng chung series A20 plus, series B20

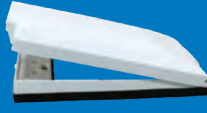
	Mã số / Diễn giải	Đơn giá(VNĐ)		Mã số / Diễn giải	Đơn giá(VNĐ)
	<b>A30NGN</b> Đèn báo xanh	17.600		<b>A30USB</b> Ổ cắm sạc USB DC 5V-1000mA	306.100
	<b>A30NRD</b> Đèn báo đỏ	17.600		<b>AV600</b> Bộ điều chỉnh tốc độ quạt 600VA-220VAC	113.200
	<b>ASV200-LED</b> Dimmer điều chỉnh độ sáng LED (dùng cho LED Dimmable) Điện áp: 220VAC Công suất: 200W	914.800		<b>AV800</b> Bộ điều chỉnh độ sáng đèn 800W-220VAC	113.200
	<b>AV200-LED</b> Dimmer điều chỉnh độ sáng LED (dùng cho LED Dimmable) Điện áp: 220VAC Công suất: 200W	698.800		<b>AV1200</b> Bộ điều chỉnh độ sáng đèn 1.200W-220VAC	139.800
	<b>A30P</b> Nắp che trơn	4.500		<b>AKT</b> Chìa khóa dùng cho A20KTN	48.300
	<b>A30MBP</b> Nút nhấn chuông 3A	28.700		<b>A20KTN</b> Công tắc 2 cực 20A dùng chìa khóa	256.600

## Nhóm hộp âm, hộp nổi, hộp chống thấm

	Mã số / Diễn giải	Đơn giá (VNĐ)		Mã số / Diễn giải	Đơn giá (VNĐ)
	<b>CA157N</b> Nắp che dùng cho hộp A157N	6.300		<b>S223</b> Hộp chống thấm vuông cho series B20, S60, S70 KT: 100x118x48 mm	126.500
	<b>A157N</b> Hộp nhựa âm tường đơn Kt: 105x65x40mm	6.300		<b>AKSB</b> Hộp nhựa nổi dùng cho SB Kt: 104x44x40mm	11.100
	<b>A157ND</b> Hộp nhựa âm tường dùng cho 2 mặt đơn Kt: 134x105x40mm	16.500		<b>AK01</b> Hộp nhựa nổi đơn Kt: 120x70x34mm	9.900
	<b>A157V</b> Đế âm chống cháy dùng cho các mặt nạ vuông Kt: 75x75x50mm	11.000		<b>AK02</b> Hộp nhựa nổi đôi Kt: 120x116x34mm	19.700
	<b>A157V2</b> Hộp đế nhựa vuông đôi kiểu Anh Kt: 135x75x50mm	26.300		<b>A6K01</b> Đế nổi dùng cho mặt nạ đơn seri A60, A70 plus Kt: 120x70x33mm	13.100
	<b>A157 MCB</b> Hộp nhựa âm tường dùng cho MCB Kt: 114x65x57mm	12.800		<b>A6K02</b> Đế nổi dùng cho mặt nạ đôi seri A60, A70 plus Kt: 120x117x33mm	19.700
	<b>AK2237N</b> Hộp nhựa nổi dùng cho các mặt, ổ cắm A20 và viên A20-WN Kt: 120x72x34mm	14.700		<b>A223V</b> Mặt che phòng thấm nước dùng cho các mặt & ổ cắm chữ nhật	119.900
	<b>AK2237ND</b> Hộp nhựa nổi dùng cho viên A20-WND Kt: 120x142x34mm	28.900		<b>A223</b> Mặt che phòng thấm nước dùng cho các mặt & ổ cắm A30	275.000
	<b>A157N2</b> Hộp nhựa âm tường dùng cho mặt đôi Kt: 110x106x40mm	16.700		<b>A223S</b> Mặt che phòng thấm nước dùng cho các mặt & ổ cắm chữ nhật	108.900



## Khả năng chịu lực



## Chịu nhiệt độ cao

### Đặc điểm :

- Ống luồn cứng PVC được làm từ nhựa PVC cao cấp, sản xuất theo tiêu chuẩn BSEN 61386-21
- Ống PVC có 3 loại: Medium duty ( chịu được lực nén 750N) và Heavy duty (chịu được lực nén 1250N).
- Ống PVC có các tính chất ưu việt sau:
  - + Chịu được lực nén cao: không bị nứt, vỡ khi lắp đặt trong âm tường, âm sàn và dưới đất.
  - + Chịu được va đập mạnh
  - + Độ uốn dẻo cao: dễ dàng uốn cong theo ý muốn, có thể uốn cong đến 90°.
  - + Cách điện tốt: chịu được điện áp đến 2,000V
  - + Khả năng tự chống cháy: không cháy thành ngọn lửa khi đốt cháy trực tiếp, ngọn lửa tự dập tắt trong thời gian nhỏ hơn 30 giây.
  - + Chống ăn mòn và chống tia UV





### Ứng dụng :

- Dùng để lắp đặt trong các công trình xây dựng: lắp nổi trên trần, âm trong tường, sàn bê tông hoặc chôn dưới đất.
- Dùng trong các nơi đòi hỏi độ va đập cao, chống cháy, chống ăn mòn và cách điện...





# Ống luồn

## Ống Luồn 320N

	Mã hàng Model	Chiều dài (mm)	Đường kính ngoài +/- 0.15mm	Độ dày (+/- 0.1mm)	Đóng gói Package	Trọng lượng (kg/bó)	Đơn giá (VNĐ/cây)
	<b>A9016L</b>	2920mm	Ø 16mm	1.3mm	50 ống/bó	13 kg	<b>31.100</b>
	<b>A9020L</b>	2920mm	Ø 20mm	1.4mm	30 ống/bó	10.2 kg	<b>40.100</b>
	<b>A9025L</b>	2920mm	Ø 25mm	1.6mm	25 ống/bó	12.75 kg	<b>61.000</b>
	<b>A9032L</b>	2920mm	Ø 32mm	1.9mm	15 ống/bó	10.95 kg	<b>98.900</b>

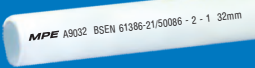

Tiêu chuẩn: BSEN 50086-2-1/BSEN 61386-21

## Ống Luồn 750N

	Mã hàng Model	Chiều dài (mm)	Đường kính ngoài +/- 0.15mm	Độ dày (+/- 0.05mm)	Đóng gói Package	Trọng lượng (kg/bó)	Đơn giá (VNĐ/cây)
	<b>A9016</b>	2920mm	Ø 16mm	1.3mm	50 ống/bó	13 kg	<b>34.500</b>
	<b>A9020</b>	2920mm	Ø 20mm	1.5mm	30 ống/bó	11.55 kg	<b>47.700</b>
	<b>A9025</b>	2920mm	Ø 25mm	1.7mm	25 ống/bó	14.12 kg	<b>69.900</b>
	<b>A9032</b>	2920mm	Ø 32mm	1.9mm	15 ống/bó	13.05 kg	<b>111.600</b>

Tiêu chuẩn: BSEN 50086-2-1/BSEN 61386-21

## Ống Luồn Heavy 1250N

	Mã hàng Model	Chiều dài (mm)	Đường kính ngoài +/- 0.15mm	Độ dày (+/- 0.05mm)	Đóng gói Package	Trọng lượng (kg/bó)	Đơn giá (VNĐ/cây)
	<b>A9020HV</b>	2920mm	Ø 20mm	1.8mm	30 ống/bó	13.95 kg	<b>62.700</b>
	<b>A9025HV</b>	2920mm	Ø 25mm	1.9mm	25 ống/bó	16.87 kg	<b>89.400</b>
	<b>A9032HV</b>	2920mm	Ø 32mm	2.1mm	15 ống/bó	14.47 kg	<b>166.700</b>

Tiêu chuẩn: BSEN 50086-2-1/BSEN 61386-21

# Lò xo uốn ống New

Lò xo uốn ống  
dùng cho ống 320N và 750N

	Mã hàng Model	Đường kính +/- 0.2mm	Chiều dài (mm)	Đơn giá (VNĐ/cây)
	BS-16	12mm	55mm	42.400
	BS-20	15.9mm	55mm	59.100
	BS-25	21.2mm	55mm	89.400
	BS-32	27.8mm	55mm	140.600





















## Phụ kiện





	Mã số / Diễn giải	Đơn giá(VNĐ)		Mã số / Diễn giải	Đơn giá(VNĐ)
	<b>A258/16</b> Khớp nối răng 16mm	<b>3.900</b>		<b>A246N/20</b> - Co chữ T - Co nối 20mm (có nắp)	<b>10.800</b>
	<b>A258/20</b> Khớp nối răng 20mm	<b>4.200</b>		<b>A246N/25</b> - Co chữ T - Co nối 25mm (có nắp)	<b>15.000</b>
	<b>A258/25</b> Khớp nối răng 25mm	<b>5.200</b>		<b>A246/16</b> - Co chữ T - Co nối 16mm (không nắp)	<b>5.500</b>
	<b>A258/32</b> Khớp nối răng 32mm	<b>8.600</b>		<b>A246/20</b> - Co chữ T - Co nối 20mm (không nắp)	<b>6.700</b>
	<b>A244N/20</b> - Co chữ L - Co nối 20mm (có nắp)	<b>7.400</b>		<b>A246/25</b> - Co chữ T - Co nối 25mm (không nắp)	<b>9.100</b>
	<b>A244N/25</b> - Co chữ L - Co nối 25mm (có nắp)	<b>12.700</b>		<b>A246/32</b> - Co chữ T - Co nối 32mm (không nắp)	<b>12.000</b>
	<b>A244/16</b> - Co chữ L - Co nối 16mm (không nắp)	<b>2.600</b>		<b>A242/16</b> Khớp nối trơn 16mm	<b>1.300</b>
	<b>A244/20</b> - Co chữ L - Co nối 20mm (không nắp)	<b>4.000</b>		<b>A242/20</b> Khớp nối trơn 20mm	<b>1.500</b>
	<b>A244/25</b> - Co chữ L - Co nối 25mm (không nắp)	<b>6.000</b>		<b>A242/25</b> Khớp nối trơn 25mm	<b>2.300</b>
	<b>A244/32</b> - Co chữ L - Co nối 32mm (không nắp)	<b>8.500</b>		<b>A242/32</b> Khớp nối trơn 32mm	<b>5.200</b>
	<b>A240L</b> - Nắp hộp nối tròn - Tiêu chuẩn BS4607	<b>2.500</b>		<b>A242/20-16</b> Nối trơn giảm 20-16mm	<b>2.000</b>







## Phụ kiện

	Mã số / Diễn giải	Đơn giá(VNĐ)		Mã số / Diễn giải	Đơn giá(VNĐ)
	<b>A242/25-20</b> Nối trơn giảm 25-20mm	5.800		<b>A240/20/1</b> Hộp nối dây 1 đường Ø 20mm	11.100
	<b>A242/32-16</b> Nối trơn giảm 32-16mm	5.800		<b>A240/20/2</b> Hộp nối dây 2 đường Ø 20mm	11.100
	<b>A242/32-20</b> Nối trơn giảm 32-20mm	5.800		<b>A240/20/2A</b> Hộp nối dây 2 đường Ø 20mm	11.100
	<b>A242/32-25</b> Nối trơn giảm 32-25mm	5.800		<b>A240/20/3</b> Hộp nối dây 3 đường Ø 20mm	11.100
	<b>A240/16/1</b> Hộp nối 1 đường thẳng Ø 16mm	10.700		<b>A240/20/4</b> Hộp nối dây 4 đường Ø 20mm	11.100
	<b>A240/16/2</b> Hộp nối 2 đường thẳng Ø 16mm	10.700		<b>A240/25/1</b> Hộp nối 1 đường thẳng Ø 25mm	12.500
	<b>A240/16/2A</b> Hộp nối 2 đường vuông Ø 16mm	10.700		<b>A240/25/2</b> Hộp nối 2 đường thẳng Ø 25mm	12.500
	<b>A240/16/3</b> Hộp nối 3 đường Ø 16mm	10.700		<b>A240/25/2A</b> Hộp nối 2 đường vuông Ø 25mm	12.500
	<b>A240/16/4</b> Hộp nối 4 đường Ø 16mm	10.700		<b>A240/25/3</b> Hộp nối 3 đường Ø 25mm	12.500

## Phụ kiện

	Mã số / Diễn giải	Đơn giá (VNĐ)		Mã số / Diễn giải	Đơn giá (VNĐ)
	<b>A240/25/4</b> Hộp nối 4 đường Ø 25mm	12.500		<b>A442</b> Hộp nối (101x101x50)mm	35.000
	<b>A240/32/1</b> Hộp nối 1 đường thẳng Ø 32mm	17.200		<b>A662</b> Hộp nối (152x152x50)mm	63.400
	<b>A240/32/2</b> Hộp nối 2 đường thẳng Ø 32mm	17.200		<b>A882</b> Hộp nối (190x190x50)mm	112.200
	<b>A240/32/2A</b> Hộp nối 2 đường vuông Ø 32mm	17.200		<b>A280/16</b> Kẹp đỡ ống 16mm	1.500
	<b>A240/32/3</b> Hộp nối 3 đường Ø 32mm	17.200		<b>A280/20</b> Kẹp đỡ ống 20mm	1.700
	<b>A240/32/4</b> Hộp nối 4 đường Ø 32mm	17.200		<b>A280/25</b> Kẹp đỡ ống 25mm	2.700
	<b>A332</b> Hộp nối 76x76x50mm	28.000		<b>A280/32</b> Kẹp đỡ ống 32mm	4.500

## Ống luồn đàn hồi

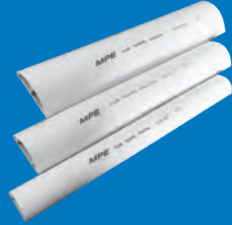

Ống luồn	Mã hàng	Diễn giải	Kích thước cuộn			Trọng lượng (Kg)	Đóng gói (m/cuộn)	Đơn giá (VNĐ/cuộn)
			Đường kính trong (mm)	Đường kính ngoài (mm)	Chiều cao (mm)			
	<b>A9016CM</b>	Ống luồn đàn hồi Ø 16	Ø 240	Ø 280	165mm	1.6Kg	50m/cuộn	<b>229.300</b>
	<b>A9016CT</b>	Ống luồn đàn hồi màu trắng Ø 16						
	<b>A9020CM</b>	Ống luồn đàn hồi Ø 20	Ø 250	Ø 430	190mm	2.3Kg	50m/cuộn	<b>284.700</b>
	<b>A9020CT</b>	Ống luồn đàn hồi màu trắng Ø 20						
	<b>A9025CM</b>	Ống luồn đàn hồi Ø 25	Ø 270	Ø 440	240mm	2.5Kg	40m/cuộn	<b>327.200</b>
	<b>A9025CT</b>	Ống luồn đàn hồi màu trắng Ø 25						
	<b>A9032CM</b>	Ống luồn đàn hồi Ø 32	Ø 280	Ø 350	240mm	2.4Kg	25m/cuộn	<b>402.900</b>
	<b>A9032CT</b>	Ống luồn đàn hồi màu trắng Ø 32						

## Nẹp bán nguyệt

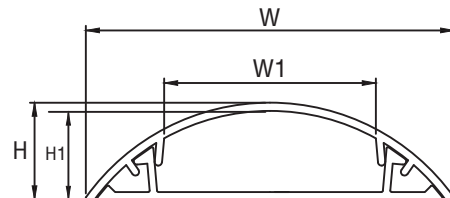
	Mã hàng Model	Kích thước (WxW1xHxH1xL)	Đơn giá (VNĐ)
	<b>NBN40/13</b>	40x16x13x11x1200 mm	-
	<b>NBN60/20</b>	60x27x20x17x1200 mm	-
	<b>NBN80/22</b>	80x46x22x19x1200 mm	-



Kích thước

	<b>MP 20/10</b>	Ống luồn dẹp 20x10mm, dài 2m	<b>15.000</b>		<b>MP 50/35</b>	Ống luồn dẹp 50x35mm, dài 2m	<b>74.600</b>
	<b>MP 25/14</b>	Ống luồn dẹp 25x14mm, dài 2m	<b>21.800</b>		<b>MP 60/40</b>	Ống luồn dẹp 60x40mm, dài 2m	<b>93.300</b>
	<b>MP 30/16</b>	Ống luồn dẹp 30x16mm, dài 2m	<b>28.100</b>		<b>MP 80/50</b>	Ống luồn dẹp 80x50mm, dài 2m	<b>150.700</b>
	<b>MP 40/22</b>	Ống luồn dẹp 40x22mm, dài 2m	<b>45.500</b>		<b>MP 100/40</b>	Ống luồn dẹp 100x40mm, dài 2m	<b>185.300</b>
					<b>MP 100/60</b>	Ống luồn dẹp 100x60mm, dài 2m	<b>236.200</b>

# THIẾT BỊ ĐÓNG CẮT, TỬ ĐIỆN



- MCB, MCCB dòng cắt cao 4.5kA, 6kA, 10kA, 35kA, 50kA, 75kA
- RCBO bảo vệ quá tải & chống giật

## Thiết bị đóng ngắt, bảo vệ MCB

	Mã hàng Model	Số cực	Dòng định mức In (A)	Icu (kA)	Đơn giá (VNĐ)
 <p><b>4.5kA - 6kA</b></p>	MP6-C106	1P	6A	6kA	<b>72.500</b>
	MP6-C110	1P	10A	6kA	<b>72.500</b>
	MP6-C116	1P	16A	6kA	<b>72.500</b>
	MP6-C120	1P	20A	6kA	<b>72.500</b>
	MP6-C125	1P	25A	6kA	<b>72.500</b>
	MP6-C132	1P	32A	6kA	<b>72.500</b>
	MP6-C140	1P	40A	6kA	<b>72.500</b>
	MP4-C150	1P	50A	4.5kA	<b>97.700</b>
	MP4-C163	1P	63A	4.5kA	<b>97.700</b>
	 <p><b>6kA</b></p>	MP6-C150	1P	50A	6kA
MP6-C163		1P	63A	6kA	<b>108.900</b>
 <p><b>4.5kA - 6kA</b></p>	MP6-C206	2P	6A	6kA	<b>158.200</b>
	MP6-C210	2P	10A	6kA	<b>158.200</b>
	MP6-C216	2P	16A	6kA	<b>158.200</b>
	MP6-C220	2P	20A	6kA	<b>158.200</b>

## Thiết bị đóng ngắt, bảo vệ MCB

	Mã hàng Model	Số cực	Dòng định mức In (A)	Icu (kA)	Đơn giá (VNĐ)
 <p><b>4.5kA - 6kA</b></p>	MP6-C225	2P	25A	6kA	<b>158.200</b>
	MP6-C232	2P	32A	6kA	<b>158.200</b>
	MP6-C240	2P	40A	6kA	<b>158.200</b>
	MP4-C250	2P	50A	4.5kA	<b>208.100</b>
	MP4-C263	2P	63A	4.5kA	<b>208.100</b>
 <p><b>6kA</b></p>	MP6-C250	2P	50A	6kA	<b>234.700</b>
	MP6-C263	2P	63A	6kA	<b>234.700</b>
 <p><b>10kA</b></p>	MP10-C250	2P	50A	10kA	<b>417.500</b>
	MP10-C263	2P	63A	10kA	<b>417.500</b>
	MP10-C280	2P	80A	10kA	<b>592.900</b>
	MP10-C2100	2P	100A	10kA	<b>592.900</b>
 <p><b>4.5kA - 6kA</b></p>	MP6-C310	3P	10A	6kA	<b>248.400</b>
	MP6-C316	3P	16A	6kA	<b>248.400</b>
	MP6-C320	3P	20A	6kA	<b>248.400</b>
	MP6-C325	3P	25A	6kA	<b>248.400</b>

## Thiết bị đóng ngắt, bảo vệ MCB

	Mã hàng Model	Số cực	Dòng định mức In (A)	Icu (kA)	Đơn giá (VNĐ)
 <p><b>4.5kA - 6kA</b></p>	MP6-C332	3P	32A	6kA	<b>248.400</b>
	MP6-C340	3P	40A	6kA	<b>248.400</b>
	MP4-C350	3P	50A	4,5kA	<b>334.000</b>
	MP4-C363	3P	63A	4,5kA	<b>334.000</b>
 <p><b>6kA</b></p>	MP6-C350	3P	50A	6kA	<b>369.100</b>
	MP6-C363	3P	63A	6kA	<b>369.100</b>
 <p><b>10kA</b></p>	MP10-C380	3P	80A	10kA	<b>907.500</b>
	MP10-C3100	3P	100A	10kA	<b>907.500</b>
 <p><b>6kA</b></p>	MP6-C410	4P	10A	6kA	<b>346.400</b>
	MP6-C416	4P	16A	6kA	<b>346.400</b>
 <p><b>6kA</b></p>	MP6-C420	4P	20A	6kA	<b>346.400</b>
	MP6-C425	4P	25A	6kA	<b>346.400</b>
	MP6-C432	4P	32A	6kA	<b>346.400</b>
	MP6-C440	4P	40A	6kA	<b>346.400</b>
	MP6-C450	4P	50A	6kA	<b>508.200</b>
	MP6-C463	4P	63A	6kA	<b>508.200</b>

## Thiết bị đóng ngắt, bảo vệ dòng rò & quá tải

### RCCB



Mã hàng Model	Số cực	Dòng định mức In (A)	Dòng rò I <sub>Δn</sub> (mA)	Đơn giá (VNĐ)
MEL-30/225	2P	25A	30mA	492.000
MEL-30/232	2P	32A	30mA	529.000
MEL-30/240	2P	40A	30mA	529.000
MEL-30/263	2P	63A	30mA	748.400
MEL-30/425	4P	25A	30mA	762.300
MEL-30/432	4P	32A	30mA	813.100
MEL-30/440	4P	40A	30mA	813.100
MEL-30/463	4P	63A	30mA	1.083.400

### RCBO



Mã hàng Model	Số cực	Dòng định mức In (A)	Dòng rò I <sub>Δn</sub> (mA)	I <sub>cu</sub> (kA)	Đơn giá (VNĐ)
RCBO-15/216	2P	16A	15mA	6kA	518.100
RCBO-30/216	2P	16A	30mA	6kA	518.100
RCBO-30/220	2P	20A	30mA	6kA	518.100
RCBO-30/225	2P	25A	30mA	6kA	518.100
RCBO-30/232	2P	32A	30mA	6kA	518.100
RCBO-30/240	2P	40A	30mA	6kA	562.100
RCBO-30/263	2P	63A	30mA	6kA	795.300



# Cầu dao an toàn

SB



Mã số / Diễn giải	Đơn giá (VNĐ)
<b>SB-10</b> Cầu dao an toàn 10A 10A Safety Breaker	59.400
<b>SB-15</b> Cầu dao an toàn 15A 15A Safety Breaker	59.400
<b>SB-20</b> Cầu dao an toàn 20A 20A Safety Breaker	59.400
<b>SB-30</b> Cầu dao an toàn 30A 30A Safety Breaker	59.400
<b>SB-40</b> Cầu dao an toàn 40A 40A Safety Breaker	59.400

## Kích Thước MCB - RCBO

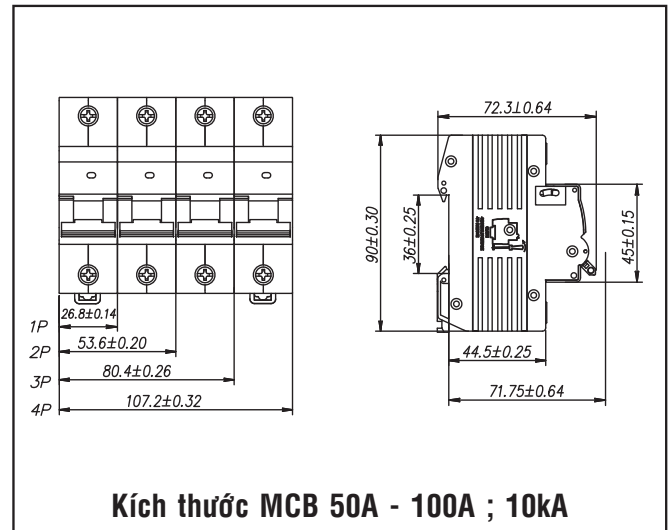
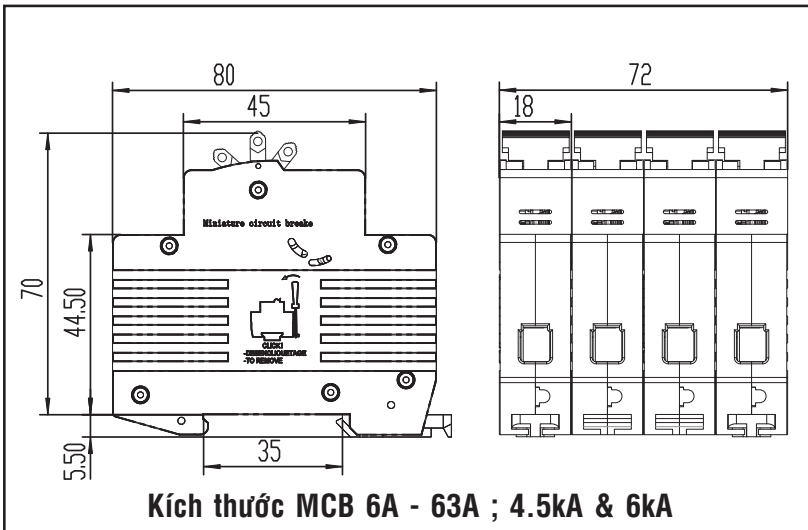
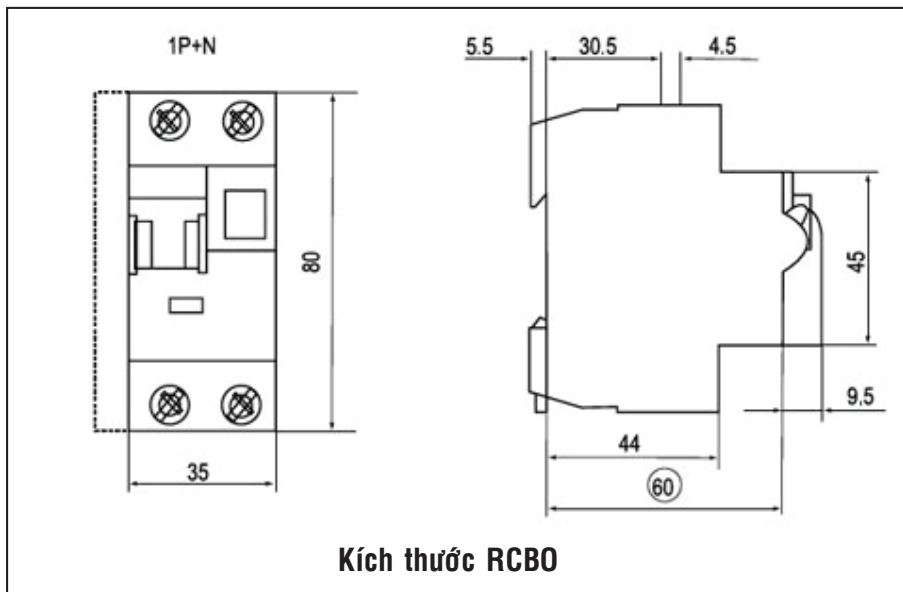



Thanh ray lắp CB  
di chuyển linh hoạt

Thanh dẫn điện bằng đồng



### Tủ điện âm tường MPE - Nét độc đáo trong thiết kế

- Sản phẩm có thiết kế tinh tế, hiện đại
- Thanh ray lắp CB có thể điều chỉnh hướng lắp đặt
- Thanh dẫn điện bằng đồng được cách điện bằng đế nhựa
- Thân tủ bằng thép và phủ sơn tĩnh điện, chống va đập cao
- Không gian bên trong tủ rộng rãi, dễ dàng cho việc đấu nối
- Kích thước, mẫu mã đa dạng

### ỨNG DỤNG:

- Sử dụng cho văn phòng, căn hộ, nhà phố,...

## DIALux

German Technology



## Tủ điện seri TS

Tủ Điện Seri TS	Mã hàng Model	Số cực	Kích thước (AxBxCxDxH1xH2)mm	Đơn giá (VNĐ)
	Tủ TS-4	2-4	148x160x128x148x90x70	<b>162.900</b>
	Tủ TS-6	5-6	200x216x180x190x90x70	<b>216.000</b>
	<b>New</b> Tủ TS-10	7-10	290x217x267x185x90x70	<b>336.000</b>
	Tủ TS-12	10-12	311x248x286x226x90x70	<b>346.500</b>
	Tủ TS-14	11-14	349x248x326x228x90x70	<b>450.500</b>
	Tủ TS-20	15-20	468x248x434x228x96x76	<b>680.400</b>
	Tủ TS-24	21-24	311x404x290x385x96x76	<b>970.200</b>
	Tủ TS-32	25-32	396x496x372x475x96x76	<b>1.192.000</b>
	Tủ TS-40	33-40	468x496x443x475x96x76	<b>1.375.700</b>
	Tủ TS-48	41-48	395x745x371x724x96x76	<b>2.574.000</b>
	Tủ TS-60	49-60	468x745x444x724x96x76	<b>3.289.000</b>

### Kích Thước Tủ Điện

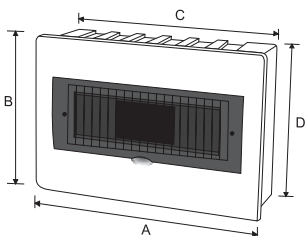

Phần thanh ray có thể thay đổi hướng lắp đặt



Thanh dẫn điện bằng đồng

## Tủ điện seri TN + seri WP (chống thấm nước)

### Tủ Điện Seri TN - IP30



Mã hàng Model	Số cực	Kích thước (LxHxW)mm	Đơn giá (VNĐ)
Tủ TN-2	1-2	66x125x85 mm	<b>60.500</b>
Tủ TN-4	3-4	93x124x85 mm	<b>78.100</b>

### Tủ Điện chống thấm Seri WP - IP65



Mã hàng Model	Số cực	Kích thước (LxHxW)mm	Đơn giá (VNĐ)
Tủ WP-4	2-4	107x212x92 mm	<b>750.800</b>
Tủ WP-6	5-6	165x200x100 mm	<b>935.600</b>
Tủ WP-9	7-9	219x200x100 mm	<b>1.150.400</b>
Tủ WP-12	10-12	273x230x110 mm	<b>1.556.900</b>
Tủ WP-18	13-18	381x230x110 mm	<b>2.106.700</b>
Tủ WP-24	19-24	273x380x110 mm	<b>2.743.200</b>
Tủ WP-36	25-36	381x380x110 mm	<b>3.768.800</b>

## Tủ điện seri T

Tủ Điện Seri T	Mã hàng Model	Số cực	Kích thước (AxBxCxDxH1xH2)mm	Đơn giá (VNĐ)
	Tủ T4	2-4	148x160x128x135x89x70 mm	<b>170.500</b>
	Tủ T6	5-6	215x199x188x170x89x70 mm	<b>226.600</b>
	Tủ T10	7-10	287x213x258x185x89x70 mm	<b>363.000</b>
	Tủ T14	11-14	362x248x330x216x89x70 mm	<b>471.900</b>
	Tủ T20	15-20	470x248x440x216x95x76 mm	<b>712.800</b>
	Tủ T24	21-24	323x382x300x355x95x76 mm	<b>1.016.400</b>
	Tủ T32	25-32	398x500x365x460x105x76 mm	<b>1.248.500</b>
	Tủ T40	33-40	470x500x440x460x105x76 mm	<b>1.441.000</b>

### Kích Thước Tủ Điện

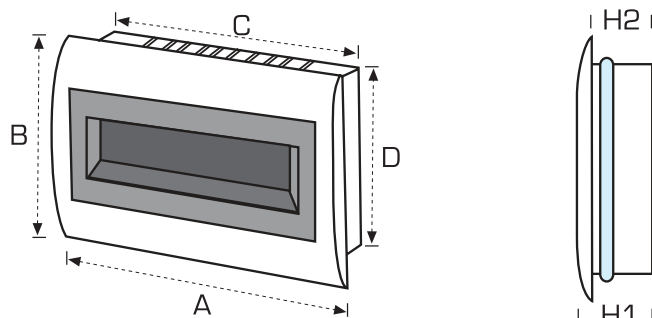



## THIẾT BỊ CÔNG NGHIỆP

 Thay đổi linh kiện linh hoạt đáp ứng nhu cầu sử dụng, dễ lắp đặt, an toàn cao

 Sử dụng để sắt



-  Làm bằng nhựa cao cấp chịu nhiệt và cách điện cao
-  Thân nhựa kín nước hoàn toàn
-  Dễ lắp đặt, độ an toàn cao



# Phích cắm công nghiệp

**MPN-013**  
**MPN-023**



Vị trí cực nối đất		6h	
Dòng điện định mức (A)		16	32
Số cực		3	
Kích thước (mm)	a	118	146
	b	82	100
	c	47	63
	d	6-15	10-20
	sw	38	50
Tiết diện định mức dây cáp (mm <sup>2</sup> )		1-2.5	2.5-6

Current(A): 16A, 32A  
Voltage(V): 240~2P+E  
Protection degree: IP44

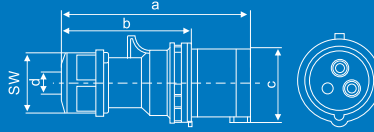

Mã hàng Model	Đơn giá (VNĐ)
---------------	---------------

**MPN-013**  
16A, 240V  
2P+E-IP44

**75.100**

**MPN-023**  
32A, 240V  
2P+E-IP44

**132.800**

**MPN-0132**  
**MPN-0232**



Vị trí cực nối đất		6h	
Dòng điện định mức (A)		16	32
Số cực		3	
Kích thước (mm)	a	118	146
	b	82	100
	d	6-15	10-20
	sw	38	50
	Tiết diện định mức dây cáp (mm <sup>2</sup> )		1-2.5

Current(A): 16A, 32A  
Voltage(V): 220-240V~2P+E  
Protection degree: IP67

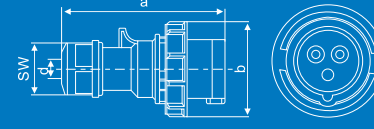

Mã hàng Model	Đơn giá (VNĐ)
---------------	---------------

**MPN-0132**  
16A, 240V  
2P+E-IP67

**244.900**

**MPN-0232**  
32A, 240V  
2P+E-IP67

**300.300**

**MPN-014**  
**MPN-024**



Vị trí cực nối đất		6h	
Dòng điện định mức (A)		16	32
Số cực		4	
Kích thước (mm)	a	124	146
	b	88	100
	c	53	63
	d	6-15	10-20
	sw	38	50
Tiết diện định mức dây cáp (mm <sup>2</sup> )		1-2.5	2.5-6

Current(A): 16A, 32A  
Voltage(V): 380-415V~3P+E  
Protection degree: IP44

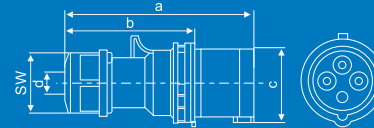

Mã hàng Model	Đơn giá (VNĐ)
---------------	---------------

**MPN-014**  
16A, 380-415V  
3P+E-IP44

**104.000**

**MPN-024**  
32A, 380-415V  
3P+E-IP44

**137.400**

**MPN-015**  
**MPN-025**



Vị trí cực nối đất		6h	
Dòng điện định mức (A)		16	32
Số cực		5	
Kích thước (mm)	a	131	152
	b	95	106
	c	61	70
	d	8-16	10-20
	sw	42	50
Tiết diện định mức dây cáp (mm <sup>2</sup> )		1-2.5	2.5-6

Current(A): 16A, 32A  
Voltage(V): 220-380V~ 3P+N+E  
240-415V~  
Protection degree: IP44

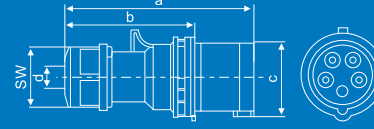

Mã hàng Model	Đơn giá (VNĐ)
---------------	---------------

**MPN-015**  
16A, 380-415V  
3P+N+E-IP44

**116.700**

**MPN-025**  
32A, 380-415V  
3P+N+E-IP44

**172.100**

**MPN-0142**  
**MPN-0242**



Vị trí cực nối đất		6h	
Dòng điện định mức (A)		16	32
Số cực		4	
Kích thước (mm)	a	124	146
	b	79	93
	d	6-15	10-20
	sw	38	50
	Tiết diện định mức dây cáp (mm <sup>2</sup> )		1-2.5

Current(A): 16A, 32A  
Voltage(V): 380-415V~3P+E  
Protection degree: IP67

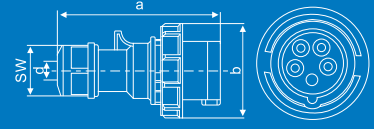

Mã hàng Model	Đơn giá (VNĐ)
---------------	---------------

**MPN-0142**  
16A, 380-415V  
3P+E-IP67

**258.700**

**MPN-0242**  
32A, 380-415V  
3P+E-IP67

**317.600**

**MPN-0152**  
**MPN-0252**



Vị trí cực nối đất		6h	
Dòng điện định mức (A)		16	32
Số cực		5	
Kích thước (mm)	a	131	152
	b	87	100
	d	8-16	10-20
	sw	42	50
	Tiết diện định mức dây cáp (mm <sup>2</sup> )		1-2.5

Current(A): 16A, 32A  
Voltage(V): 220-380V~ 3P+N+E  
240-415V~  
Protection degree: IP67

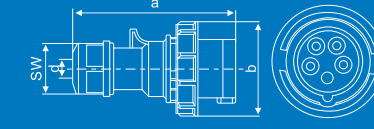

Mã hàng Model	Đơn giá (VNĐ)
---------------	---------------

**MPN-0152**  
16A, 380-415V  
3P+N+E-IP67

**277.200**

**MPN-0252**  
32A, 380-415V  
3P+N+E-IP67

**337.300**

**MPN-0342**  
**MPN-044K**



Vị trí cực nối đất		6h	
Dòng điện định mức (A)		63	125
Số cực		4	
Kích thước (mm)	a	240	295
	b	115	126
	c	30	44.5
Tiết diện định mức dây cáp (mm <sup>2</sup> )		6-16	16-50

Current(A): 63A, 125A  
Voltage(V): 380-415V~3P+E  
Protection degree: IP67

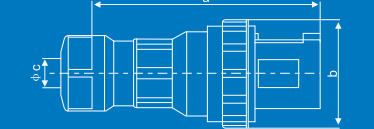

Mã hàng Model	Đơn giá (VNĐ)
---------------	---------------

**MPN-0342**  
63A, 380-415V  
3P+E-IP67

**702.200**

**MPN-044K**  
125A, 380-415V  
3P+E-IP67

**1.790.300**

# Phích cắm công nghiệp & ổ cắm công nghiệp lắp âm

**MPN-0352  
MPN-045K**



Vị trí cực nối đất	6h	
Dòng điện định mức (A)	63	125
Số cực	5	
Kích thước (mm)		
a	240	295
b	115	126
c	30	44.5
Tiết diện định mức dây cáp (mm <sup>2</sup> )	6-16	16-50

Current(A): 63A, 125A  
Voltage(V): 220-380V~  
240-415V~ 3P+N+E  
Protection degree: IP67

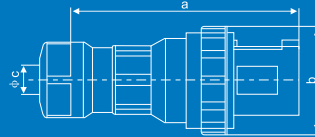

Mã hàng Model	Đơn giá (VNĐ)
---------------	---------------

<b>MPN-0352</b> 63A, 380-415V 3P+N+E-IP67	<b>669.900</b>
<b>MPN-045K</b> 125A, 380-415V 3P+N+E-IP67	<b>2.021.300</b>

**MPN-623**



Vị trí cực nối đất	6h	
Dòng điện định mức (A)	32	
Số cực	3	
Kích thước (mm)		
a	75	
b	75	
c	61	
d	61	
e	30	
f	50	
g	5	
h	55	
Tiết diện định mức dây cáp (mm <sup>2</sup> )	2.5-6	

Current(A): 32A  
Voltage(V): 220-240V~2P+E  
Protection degree: IP44

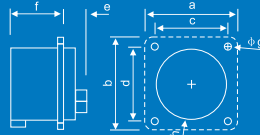

Mã hàng Model	Đơn giá (VNĐ)
---------------	---------------

<b>MPN-623</b> 32A, 240V 2P+E-IP44	<b>169.800</b>
--	----------------

**MPN-313  
MPN-323**



Vị trí cực nối đất	6h	
Dòng điện định mức (A)	16	32
Số cực	pole	3
Kích thước (mm)		
axb	76	76
cx	61	61
d	16	20
e	60	70
f	5.5	5.5
g	46	61
h	85	95
Tiết diện định mức dây cáp (mm <sup>2</sup> )	1-2.5	2.5-6

Current(A): 16A, 32A  
Voltage(V): 220-240V~2P+E  
Protection degree: IP44

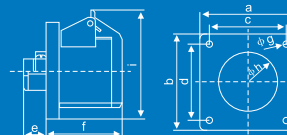

Mã hàng Model	Đơn giá (VNĐ)
---------------	---------------

<b>MPN-313</b> 16A, 240V 2P+E-IP44	<b>134.200</b>
<b>MPN-323</b> 32A, 240V 2P+E-IP44	<b>182.000</b>

**MPN-3132  
MPN-3232**



Vị trí cực nối đất	6h	
Dòng điện định mức (A)	16	32
Số cực	3	5
Kích thước (mm)		
a	75	75
b	75	75
c	61	61
d	61	61
e	18	24
f	63	70
g	43	54
h	43	54
i	5	5
Tiết diện định mức dây cáp (mm <sup>2</sup> )	1-2.5	2.5-6

Current(A): 16A, 32A  
Voltage(V): 220-240V~2P+E  
Protection degree: IP67

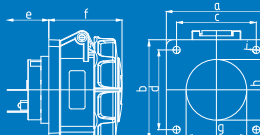

Mã hàng Model	Đơn giá (VNĐ)
---------------	---------------

<b>MPN-3132</b> 16A, 240V 2P+E-IP67	<b>300.300</b>
<b>MPN-3232</b> 32A, 240V 2P+E-IP67	<b>378.800</b>

**MPN-314  
MPN-324**



Vị trí cực nối đất	6h	
Dòng điện định mức (A)	16	32
Số cực	pole	4
Kích thước (mm)		
axb	76	76
cx	61	61
d	17	20
e	60	70
f	5.5	5.5
g	53	61
h	88	95
Tiết diện định mức dây cáp (mm <sup>2</sup> )	1-2.5	2.5-6

Current(A): 16A, 32A  
Voltage(V): 380-415V~3P+E  
Protection degree: IP44

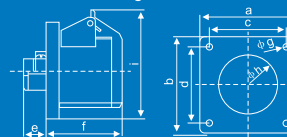

Mã hàng Model	Đơn giá (VNĐ)
---------------	---------------

<b>MPN-314</b> 16A, 380-415V 3P+E-IP44	<b>145.500</b>
<b>MPN-324</b> 32A, 380-415V 3P+E-IP44	<b>187.100</b>

**MPN-315  
MPN-325**



Vị trí cực nối đất	6h	
Dòng điện định mức (A)	16	32
Số cực	pole	5
Kích thước (mm)		
axb	76	76
cx	61	61
d	18	22
e	58	71
f	5.5	5.5
g	60	62
h	91	98
Tiết diện định mức dây cáp (mm <sup>2</sup> )	1-2.5	2.5-6

Current(A): 16A, 32A  
Voltage(V): 220-380V~  
240-415V~ 3P+N+E  
Protection degree: IP44

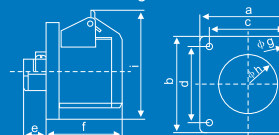

Mã hàng Model	Đơn giá (VNĐ)
---------------	---------------

<b>MPN-315</b> 16A, 380-415V 3P+N+E-IP44	<b>164.000</b>
<b>MPN-325</b> 32A, 380-415V 3P+N+E-IP44	<b>215.500</b>

**MPN-3142  
MPN-3242**



Vị trí cực nối đất	6h	
Dòng điện định mức (A)	16	32
Số cực	4	
Kích thước (mm)		
a	75	75
b	75	75
c	61	61
d	61	61
e	18	24
f	63	73
g	48	55
h	48	55
i	5	5
Tiết diện định mức dây cáp (mm <sup>2</sup> )	1-2.5	2.5-6

Current(A): 16A, 32A  
Voltage(V): 380-415V~3P+E  
Protection degree: IP67

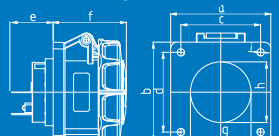

Mã hàng Model	Đơn giá (VNĐ)
---------------	---------------

<b>MPN-3142</b> 16A, 380-415V 3P+E-IP67	<b>345.300</b>
<b>MPN-3242</b> 32A, 380-415V 3P+E-IP67	<b>396.200</b>



# Ổ cắm công nghiệp lắp âm tủ điện & Ổ cắm công nghiệp lắp âm mặt nghiêng

**MPN-3152  
MPN-3252**



Vị trí cực nối đất		6h	
Dòng điện định mức (A)		16	32
Số cực		5	5
Kích thước (mm)	a	75	75
	b	75	75
	c	61	61
	d	61	61
	e	18	24
	f	63	76
	g	53	60
	h	53	60
	i	5	5
Tiết diện định mức dây cáp (mm <sup>2</sup> )		1-2.5	2.5-6

Current(A): 16A, 32A  
Voltage(V): 220-380V~  
240-415V~ 3P+N+E  
Protection degree: IP67

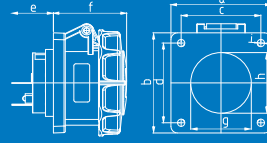

**Mã hàng Model**

**Đơn giá (VNĐ)**

**MPN-3152**  
16A, 380-415V  
3P+N+E-IP67 **368.400**

**MPN-3252**  
32A, 380-415V  
3P+N+E-IP67 **415.800**

**MPN-3342  
MPN-3442**



Vị trí cực nối đất		6h	
Dòng điện định mức (A)		63	125
Số cực		4	4
Kích thước (mm)	a	100	120
	b	100	120
	c	80	101
	d	80	101
	e	35	44
	f	96	106
	g	73	84
	h	73	84
	i	7	7
Tiết diện định mức dây cáp (mm <sup>2</sup> )		6-25	16-50

Current(A): 63A, 125A  
Voltage(V): 380-415V~3P+E  
Protection degree: IP67

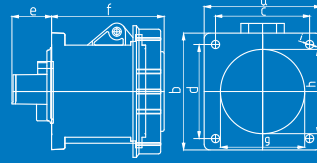

**Mã hàng Model**

**Đơn giá (VNĐ)**

**MPN-3342**  
63A, 380-415V  
3P+E-IP67 **691.800**

**MPN-3442**  
125A, 380-415V  
3P+E-IP67 **1.851.900**

**MPN-3352  
MPN-3452**



Vị trí cực nối đất		6h	
Dòng điện định mức (A)		63	125
Số cực		5	
Kích thước (mm)	a	100	120
	b	100	120
	c	80	100
	d	80	100
	e	39	45
	f	94.5	104
	g	114	127
	h	80	90
	Tiết diện định mức dây cáp (mm <sup>2</sup> )		6-16

Current(A): 63A, 125A  
Voltage(V): 220-380V~  
240-415V~ 3P+N+E  
Protection degree: IP67

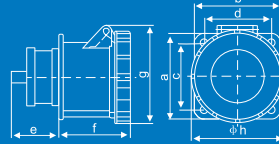

**Mã hàng Model**

**Đơn giá (VNĐ)**

**MPN-3352**  
63A, 380-415V  
3P+N+E-IP67 **779.600**

**MPN-3452**  
125A, 380-415V  
3P+N+E-IP67 **1.963.500**

**MPN-413  
MPN-423**



**Loại Nghiêng**

Vị trí cực nối đất		6h	
Dòng điện định mức (A)		16	32
Số cực		3	
Kích thước (mm)	a	85	85
	b	85	85
	c	70	70
	d	70	70
	e	33	47
	f	52	56
	g	51	64
	h	54	75
	i	5.5	5.5
Tiết diện định mức dây cáp (mm <sup>2</sup> )		1-2.5	2.5-6

Current(A): 16A, 32A  
Voltage(V): 220-240V~2P+E  
Protection degree: IP44

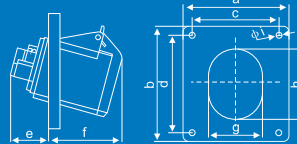

**Mã hàng Model**

**Đơn giá (VNĐ)**

**MPN-413**  
16A, 240V  
2P+E-IP44 **145.500**

**MPN-423**  
32A, 240V  
2P+E-IP44 **226.400**

**MPN-4132  
MPN-4232**



**Loại Nghiêng**

Vị trí cực nối đất		6h	
Dòng điện định mức (A)		16	32
Số cực		3	
Kích thước (mm)	a	85	85
	b	85	85
	c	70	70
	d	70	70
	e	33	47
	f	52	56
	g	51	64
	h	54	75
	i	5.5	5.5
Tiết diện định mức dây cáp (mm <sup>2</sup> )		1-2.5	2.5-6

Current(A): 16A, 32A  
Voltage(V): 220-240V~2P+E  
Protection degree: IP67

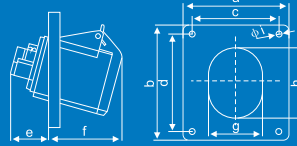

**Mã hàng Model**

**Đơn giá (VNĐ)**

**MPN-4132**  
16A, 240V  
2P+E-IP67 **229.800**

**MPN-4232**  
32A, 240V  
2P+E-IP67 **404.300**

**MPN-414  
MPN-424**



**Loại Nghiêng**

Vị trí cực nối đất		6h	
Dòng điện định mức (A)		16	32
Số cực		4	
Kích thước (mm)	a	85	85
	b	85	85
	c	70	70
	d	70	70
	e	33	47
	f	52	56
	g	57	64
	h	58	76
	i	5.5	5.5
Tiết diện định mức dây cáp (mm <sup>2</sup> )		1-2.5	2.5-6

Current(A): 16A, 32A  
Voltage(V): 380-415V~3P+E  
Protection degree: IP44

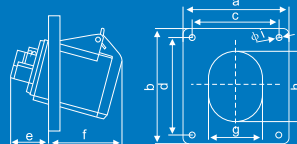

**Mã hàng Model**

**Đơn giá (VNĐ)**

**MPN-414**  
16A, 380-415V  
3P+E-IP44 **170.900**

**MPN-424**  
32A, 380-415V  
3P+E-IP44 **249.500**

**MPN-415  
MPN-425**



**Loại Nghiêng**

Vị trí cực nối đất		6h	
Dòng điện định mức (A)		16	32
Số cực		5	
Kích thước (mm)	a	85	85
	b	85	85
	c	70	70
	d	70	70
	e	35	47
	f	52	62
	g	64	69
	h	68	79
	i	5.5	5.5
Tiết diện định mức dây cáp (mm <sup>2</sup> )		1-2.5	2.5-6

Current(A): 16A, 32A  
Voltage(V): 220-380V~  
240-415V~ 3P+N+E  
Protection degree: IP44

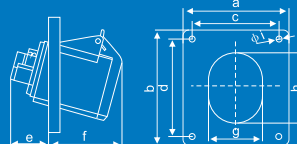







**Mã hàng Model**

**Đơn giá (VNĐ)**

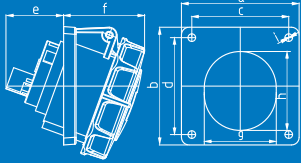
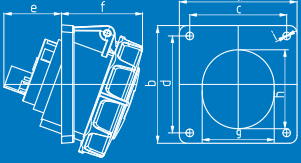
**MPN-415**  
16A, 380-415V  
3P+N+E-IP44 **190.600**

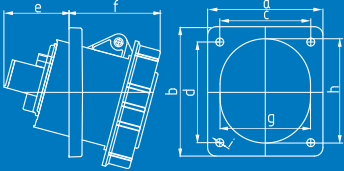
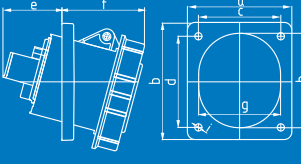
**MPN-425**  
32A, 380-415V  
3P+N+E-IP44 **272.600**

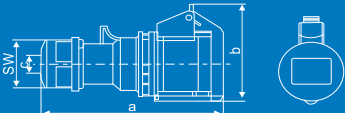
# Ổ cắm công nghiệp lắp âm mặt nghiêng & Ổ cắm công nghiệp di động có kẹp giữ dây

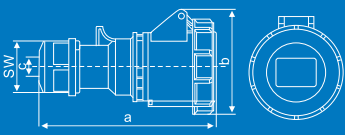
<b>MPN-4142</b> <b>MPN-4242</b> 	<b>Vị trí cực nối đất</b> <b>Dòng điện định mức (A)</b> <b>Số cực</b> <b>Kích thước (mm)</b>	<table border="1"> <thead> <tr><th colspan="2">6h</th></tr> </thead> <tbody> <tr><td>16</td><td>32</td></tr> <tr><td>4</td><td>4</td></tr> <tr><td>a</td><td>85</td></tr> <tr><td>b</td><td>85</td></tr> <tr><td>c</td><td>70</td></tr> <tr><td>d</td><td>70</td></tr> <tr><td>e</td><td>33</td></tr> <tr><td>f</td><td>50</td></tr> <tr><td>g</td><td>60</td></tr> <tr><td>h</td><td>56</td></tr> <tr><td>i</td><td>64</td></tr> <tr><td></td><td>65</td></tr> <tr><td></td><td>76</td></tr> <tr><td></td><td>5.5</td></tr> <tr><td></td><td>5.5</td></tr> </tbody> </table>	6h		16	32	4	4	a	85	b	85	c	70	d	70	e	33	f	50	g	60	h	56	i	64		65		76		5.5		5.5	Current(A): 16A. 32A Voltage(V): 380-415V~3P+E Protection degree: IP67 	<b>Mã hàng Model</b> <b>Đơn giá (VNĐ)</b>	<b>MPN-4142</b> 16A, 380-415V 3P+E-IP67 <b>244.900</b>	<b>MPN-4242</b> 32A, 380-415V 3P+E-IP67 <b>434.300</b>						
	6h																																											
16	32																																											
4	4																																											
a	85																																											
b	85																																											
c	70																																											
d	70																																											
e	33																																											
f	50																																											
g	60																																											
h	56																																											
i	64																																											
	65																																											
	76																																											
	5.5																																											
	5.5																																											
<b>Vị trí cực nối đất</b> <b>Dòng điện định mức (A)</b> <b>Số cực</b> <b>Kích thước (mm)</b>	<table border="1"> <thead> <tr><th colspan="2">6h</th></tr> </thead> <tbody> <tr><td>16</td><td>32</td></tr> <tr><td>5</td><td>5</td></tr> <tr><td>a</td><td>85</td></tr> <tr><td>b</td><td>85</td></tr> <tr><td>c</td><td>70</td></tr> <tr><td>d</td><td>70</td></tr> <tr><td>e</td><td>33</td></tr> <tr><td>f</td><td>50</td></tr> <tr><td>g</td><td>52</td></tr> <tr><td>h</td><td>62</td></tr> <tr><td>i</td><td>64</td></tr> <tr><td></td><td>70</td></tr> <tr><td></td><td>68</td></tr> <tr><td></td><td>80</td></tr> <tr><td></td><td>5.5</td></tr> <tr><td></td><td>5.5</td></tr> </tbody> </table>	6h		16	32	5	5	a	85	b	85	c	70	d	70	e	33	f	50	g	52	h	62	i	64		70		68		80		5.5		5.5	Current(A): 16A. 32A Voltage(V): 220-380V~ ~3P+N+E Protection degree: IP67 	<b>Mã hàng Model</b> <b>Đơn giá (VNĐ)</b>	<b>MPN-4152</b> 16A, 380-415V 3P+N+E-IP67 <b>254.100</b>	<b>MPN-4252</b> 32A, 380-415V 3P+N+E-IP67 <b>467.800</b>					
6h																																												
16	32																																											
5	5																																											
a	85																																											
b	85																																											
c	70																																											
d	70																																											
e	33																																											
f	50																																											
g	52																																											
h	62																																											
i	64																																											
	70																																											
	68																																											
	80																																											
	5.5																																											
	5.5																																											
<b>MPN-4342</b> <b>MPN-4442</b> 	<b>Vị trí cực nối đất</b> <b>Dòng điện định mức (A)</b> <b>Số cực</b> <b>Kích thước (mm)</b>	<table border="1"> <thead> <tr><th colspan="2">6h</th></tr> </thead> <tbody> <tr><td>63</td><td>125</td></tr> <tr><td>4</td><td>4</td></tr> <tr><td>a</td><td>101</td></tr> <tr><td>b</td><td>113</td></tr> <tr><td>c</td><td>80</td></tr> <tr><td>d</td><td>100</td></tr> <tr><td>e</td><td>89</td></tr> <tr><td>f</td><td>108</td></tr> <tr><td>g</td><td>64</td></tr> <tr><td>h</td><td>87</td></tr> <tr><td>i</td><td>83</td></tr> <tr><td></td><td>82</td></tr> <tr><td></td><td>79</td></tr> <tr><td></td><td>92</td></tr> <tr><td></td><td>92</td></tr> <tr><td></td><td>104</td></tr> <tr><td></td><td>7</td></tr> <tr><td></td><td>7.5</td></tr> </tbody> </table>	6h		63	125	4	4	a	101	b	113	c	80	d	100	e	89	f	108	g	64	h	87	i	83		82		79		92		92		104		7		7.5	Current(A): 63A. 125A Voltage(V): 380-415V~3P+E Protection degree: IP67 	<b>Mã hàng Model</b> <b>Đơn giá (VNĐ)</b>	<b>MPN-4342</b> 63A, 380-415V 3P+E-IP67 <b>693.000</b>	<b>MPN-4442</b> 125A, 380-415V 3P+E-IP67 <b>1.848.000</b>
	6h																																											
63	125																																											
4	4																																											
a	101																																											
b	113																																											
c	80																																											
d	100																																											
e	89																																											
f	108																																											
g	64																																											
h	87																																											
i	83																																											
	82																																											
	79																																											
	92																																											
	92																																											
	104																																											
	7																																											
	7.5																																											
<b>Vị trí cực nối đất</b> <b>Dòng điện định mức (A)</b> <b>Số cực</b> <b>Kích thước (mm)</b>	<table border="1"> <thead> <tr><th colspan="2">6h</th></tr> </thead> <tbody> <tr><td>63</td><td>125</td></tr> <tr><td>5</td><td>5</td></tr> <tr><td>a</td><td>101</td></tr> <tr><td>b</td><td>113</td></tr> <tr><td>c</td><td>80</td></tr> <tr><td>d</td><td>100</td></tr> <tr><td>e</td><td>89</td></tr> <tr><td>f</td><td>108</td></tr> <tr><td>g</td><td>64</td></tr> <tr><td>h</td><td>87</td></tr> <tr><td>i</td><td>83</td></tr> <tr><td></td><td>82</td></tr> <tr><td></td><td>79</td></tr> <tr><td></td><td>92</td></tr> <tr><td></td><td>92</td></tr> <tr><td></td><td>104</td></tr> <tr><td></td><td>7</td></tr> <tr><td></td><td>7.5</td></tr> </tbody> </table>	6h		63	125	5	5	a	101	b	113	c	80	d	100	e	89	f	108	g	64	h	87	i	83		82		79		92		92		104		7		7.5	Current(A): 63A. 125A Voltage(V): 220-380V~ ~3P+N+E Protection degree: IP67 	<b>Mã hàng Model</b> <b>Đơn giá (VNĐ)</b>	<b>MPN-4352</b> 63A, 380-415V 3P+N+E-IP67 <b>739.200</b>	<b>MPN-4452</b> 125A, 380-415V 3P+N+E-IP67 <b>2.044.400</b>	
6h																																												
63	125																																											
5	5																																											
a	101																																											
b	113																																											
c	80																																											
d	100																																											
e	89																																											
f	108																																											
g	64																																											
h	87																																											
i	83																																											
	82																																											
	79																																											
	92																																											
	92																																											
	104																																											
	7																																											
	7.5																																											
<b>MPN-1013</b> <b>MPN-1023</b> 	<b>MPN-1013</b> Code: 1 plug 16A Input: 220V 2P+E 3 Connector Output: 16A 220V 2P+E Protection degree: IP44 Color: Blue	<b>MPN-1023</b> Code: 1 plug 32A Input: 220V 2P+E 3 Connector Output: 32A 220V 2P+E Protection degree: IP44 Color: Blue		<b>Mã hàng Model</b> <b>Đơn giá (VNĐ)</b>	<b>MPN-1013</b> 16A, 220V 2P+E-IP44, 6h <b>606.400</b>	<b>MPN-1023</b> 32A, 220V 2P+E-IP44, 6h <b>902.600</b>																																						
	<b>Vị trí cực nối đất</b> <b>Dòng điện định mức (A)</b> <b>Số cực</b> <b>Kích thước (mm)</b>	<table border="1"> <thead> <tr><th colspan="2">6h</th></tr> </thead> <tbody> <tr><td>16</td><td>32</td></tr> <tr><td>3</td><td></td></tr> <tr><td>a</td><td>129</td></tr> <tr><td>b</td><td>76</td></tr> <tr><td>c</td><td>6-15</td></tr> <tr><td>sw</td><td>10-20</td></tr> <tr><td></td><td>38</td></tr> <tr><td></td><td>50</td></tr> </tbody> </table>	6h		16	32	3		a	129	b	76	c	6-15	sw	10-20		38		50	Current(A): 16A. 32A Voltage(V): 220-240V~2P+E Protection degree: IP44 	<b>Mã hàng Model</b> <b>Đơn giá (VNĐ)</b>	<b>MPN-213</b> 16A, 240V 2P+E-IP44 <b>106.300</b>	<b>MPN-223</b> 32A, 240V 2P+E-IP44 <b>164.000</b>																				
6h																																												
16	32																																											
3																																												
a	129																																											
b	76																																											
c	6-15																																											
sw	10-20																																											
	38																																											
	50																																											
<b>MPN-2132</b> <b>MPN-2232</b> 	<b>Vị trí cực nối đất</b> <b>Dòng điện định mức (A)</b> <b>Số cực</b> <b>Kích thước (mm)</b>	<table border="1"> <thead> <tr><th colspan="2">6h</th></tr> </thead> <tbody> <tr><td>16</td><td>32</td></tr> <tr><td>3</td><td></td></tr> <tr><td>a</td><td>133</td></tr> <tr><td>b</td><td>78</td></tr> <tr><td>c</td><td>6-15</td></tr> <tr><td>sw</td><td>10-20</td></tr> <tr><td></td><td>38</td></tr> <tr><td></td><td>50</td></tr> </tbody> </table>	6h		16	32	3		a	133	b	78	c	6-15	sw	10-20		38		50	Current(A): 16A. 32A Voltage(V): 220-240V~2P+E Protection degree: IP67 	<b>Mã hàng Model</b> <b>Đơn giá (VNĐ)</b>	<b>MPN-2132</b> 16A, 240V 2P+E-IP67 <b>274.900</b>	<b>MPN-2232</b> 32A, 240V 2P+E-IP67 <b>404.300</b>																				
	6h																																											
16	32																																											
3																																												
a	133																																											
b	78																																											
c	6-15																																											
sw	10-20																																											
	38																																											
	50																																											

# Ổ cắm công nghiệp di động có kẹp giữ dây & Ổ cắm công nghiệp lắp nổi

**MPN-214  
MPN-224**



Vị trí cực nối đất	6h	
Dòng điện định mức (A)	16	32
Số cực	4	
Kích thước (mm)	a	129
	b	76
	c	6-15
	sw	38
Tiết diện định mức dây cáp (mm <sup>2</sup> )	1-2.5	2.5-6

Current(A): 16A, 32A  
Voltage(V): 220-240V~3P+E  
Protection degree: IP44

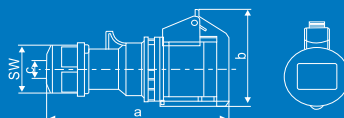

**Mã hàng  
Model**

**MPN-214**  
16A, 380-415V  
3P+E-IP44

**132.800**

**MPN-224**  
32A, 380-415V  
3P+E-IP44

**190.600**

**MPN-215  
MPN-225**



Vị trí cực nối đất	6h	
Dòng điện định mức (A)	16	32
Số cực	5	
Kích thước (mm)	a	142
	b	89
	c	8-16
	sw	42
Tiết diện định mức dây cáp (mm <sup>2</sup> )	1-2.5	2.5-6

Current(A): 16A, 32A  
Voltage(V): 220-380V~ 3P+N+E  
240-415V~  
Protection degree: IP44

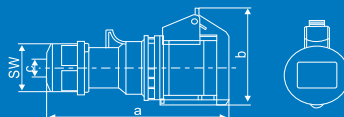

**Mã hàng  
Model**

**MPN-215**  
16A, 380-415V  
3P+N+E-IP44

**165.200**

**MPN-225**  
32A, 380-415V  
3P+N+E-IP44

**241.400**

**MPN-2142  
MPN-2242**



Vị trí cực nối đất	6h	
Dòng điện định mức (A)	16	32
Số cực	4	
Kích thước (mm)	a	139
	b	84
	c	6-15
	sw	38
Tiết diện định mức dây cáp (mm <sup>2</sup> )	1-2.5	2.5-6

Current(A): 16A, 32A  
Voltage(V): 380-415V~3P+E  
Protection degree: IP67

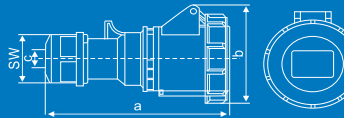

**Mã hàng  
Model**

**MPN-2142**  
16A, 380-415V  
3P+E-IP67

**304.900**

**MPN-2242**  
32A, 380-415V  
3P+E-IP67

**421.600**

**MPN-2152  
MPN-2252**



Vị trí cực nối đất	6h	
Dòng điện định mức (A)	16	32
Số cực	5	
Kích thước (mm)	a	145
	b	92
	c	8-16
	sw	42
Tiết diện định mức dây cáp (mm <sup>2</sup> )	1-2.5	2.5-6

Current(A): 16A, 32A  
Voltage(V): 220-380V~ 3P+N+E  
240-415V~  
Protection degree: IP67

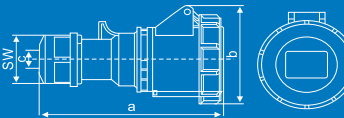

**Mã hàng  
Model**

**MPN-2152**  
16A, 380-415V  
3P+N+E-IP67

**386.900**

**MPN-2252**  
32A, 380-415V  
3P+N+E-IP67

**444.700**

**MPN-2342  
MPN-2442**



Vị trí cực nối đất	6h	
Dòng điện định mức (A)	63	125
Số cực	pole	4
Kích thước (mm)	a	261
	b	114
	c	30
	d	112
Tiết diện định mức dây cáp (mm <sup>2</sup> )	6-16	16-50

Current(A): 63A, 125A  
Voltage(V): 380-415V~3P+E  
Protection degree: IP67

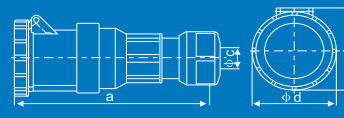

**Mã hàng  
Model**

**MPN-2342**  
63A, 380-415V  
3P+E-IP67

**895.100**

**MPN-2442**  
125A, 380-415V  
3P+E-IP67

**2.148.300**

**MPN-2352  
MPN-2452**



Vị trí cực nối đất	6h	
Dòng điện định mức (A)	63	125
Số cực	5	
Kích thước (mm)	a	261
	b	114
	c	30
	d	112
Tiết diện định mức dây cáp (mm <sup>2</sup> )	6-16	16-50

Current(A): 63A, 125A  
Voltage(V): 220-380V~ 3P+N+E  
240-415V~  
Protection degree: IP67

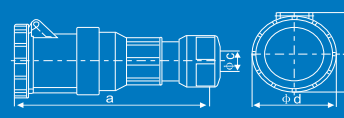

**Mã hàng  
Model**

**MPN-2352**  
63A, 380-415V  
3P+N+E-IP67

**966.700**

**MPN-2452**  
125A, 380-415V  
3P+N+E-IP67

**2.298.500**

**MPN-113  
MPN-123**



Vị trí cực nối đất	6h	
Dòng điện định mức (A)	16	32
Số cực	3	
Kích thước (mm)	a	137
	b	87
Tiết diện định mức dây cáp (mm <sup>2</sup> )	1 2 5	2 5 6

Current(A): 16A, 32A  
Voltage(V): 220-240V~2P+E  
Protection degree: IP44

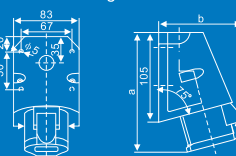

**Mã hàng  
Model**

**MPN-113**  
16A, 240V  
2P+E-IP44

**144.400**

**MPN-123**  
32A, 240V  
2P+E-IP44

**204.400**

# Ổ cắm công nghiệp lắp nổi

**MPN-1132**  
**MPN-1232**



Vị trí cực nối đất	6h	
Dòng điện định mức (A)	16	32
Số cực	3	
Kích thước (mm)	a	151
	b	96
		165
		107
Tiết diện định mức dây cáp (mm <sup>2</sup> )	1-2.5	2.5-6

Current(A): 16A, 32A  
Voltage(V): 220-240V~2P+E  
Protection degree: IP67

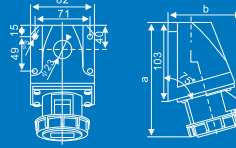

**Mã hàng Model** **Đơn giá (VNĐ)**

**MPN-1132**  
16A, 240V  
2P+E-IP67 **422.700**

**MPN-1232**  
32A, 240V  
2P+E-IP67 **542.900**

**MPN-114**  
**MPN-124**



Vị trí cực nối đất	6h	
Dòng điện định mức (A)	16	32
Số cực	4	
Kích thước (mm)	a	139
	b	95
		153
		101
Tiết diện định mức dây cáp (mm <sup>2</sup> )	1-2.5	2.5-6

Current(A): 16A, 32A  
Voltage(V): 380-415V~3P+E  
Protection degree: IP44

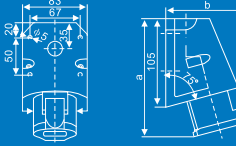

**Mã hàng Model** **Đơn giá (VNĐ)**

**MPN-114**  
16A, 380-415V  
3P+E-IP44 **175.600**

**MPN-124**  
32A, 380-415V  
3P+E-IP44 **213.700**

**MPN-115**  
**MPN-125**



Vị trí cực nối đất	6h	
Dòng điện định mức (A)	16	32
Số cực	5	
Kích thước (mm)	a	138
	b	99
		154
		104
Tiết diện định mức dây cáp (mm <sup>2</sup> )	1-2.5	2.5-6

Current(A): 16A, 32A  
Voltage(V): 220-380V~  
240-415V~ 3P+N+E  
Protection degree: IP44

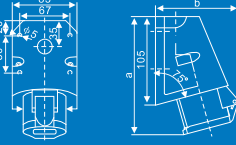

**Mã hàng Model** **Đơn giá (VNĐ)**

**MPN-115**  
16A, 380-415V  
3P+N+E-IP44 **186.000**

**MPN-125**  
32A, 380-415V  
3P+N+E-IP44 **228.700**

**MPN-1142**  
**MPN-1242**



Vị trí cực nối đất	6h	
Dòng điện định mức (A)	16	32
Số cực	4	
Kích thước (mm)	a	155
	b	98
		165
		107
Tiết diện định mức dây cáp (mm <sup>2</sup> )	1-2.5	2.5-6

Current(A): 16A, 32A  
Voltage(V): 380-415V~3P+E  
Protection degree: IP67

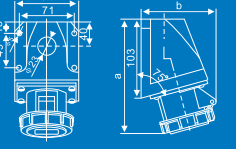

**Mã hàng Model** **Đơn giá (VNĐ)**

**MPN-1142**  
16A, 380-415V  
3P+E-IP67 **460.800**

**MPN-1242**  
32A, 380-415V  
3P+E-IP67 **576.300**

**MPN-1152**  
**MPN-1252**



Vị trí cực nối đất	6h	
Dòng điện định mức (A)	16	32
Số cực	5	
Kích thước (mm)	a	153
	b	103
		166
		109
Tiết diện định mức dây cáp (mm <sup>2</sup> )	1-2.5	2.5-6

Current(A): 16A, 32A  
Voltage(V): 220-380V~  
240-415V~ 3P+N+E  
Protection degree: IP67

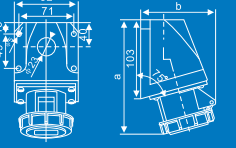

**Mã hàng Model** **Đơn giá (VNĐ)**

**MPN-1152**  
16A, 380-415V  
3P+N+E-IP67 **504.700**

**MPN-1252**  
32A, 380-415V  
3P+N+E-IP67 **614.500**

**MPN-1342**  
**MPN-1442**



Vị trí cực nối đất	6h	
Dòng điện định mức (A)	63	125
Số cực	pole	4
Kích thước (mm)	a	171
	b	170
	c	250
	d	118
	e	137
	f	104
		220
		220
		285
		140
		185
		130
Tiết diện định mức dây cáp (mm <sup>2</sup> )	6-16	16-50

Current(A): 63A, 125A  
Voltage(V): 380-415V~3P+E  
Protection degree: IP67

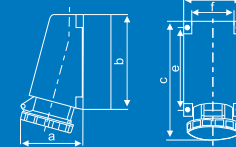

**Mã hàng Model** **Đơn giá (VNĐ)**

**MPN-1342**  
63A, 380-415V  
3P+E-IP67 **1.060.300**

**MPN-1442**  
125A, 380-415V  
3P+E-IP67 **2.650.700**

**MPN-1352**  
**MPN-1452**



Vị trí cực nối đất	6h	
Dòng điện định mức (A)	63	125
Số cực	pole	5
Kích thước (mm)	a	171
	b	170
	c	250
	d	118
	e	137
	f	104
		220
		220
		285
		140
		185
		130
Tiết diện định mức dây cáp (mm <sup>2</sup> )	6-16	16-50

Current(A): 63A, 125A  
Voltage(V): 220-380V~  
240-415V~ 3P+N+E  
Protection degree: IP67

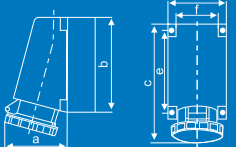

**Mã hàng Model** **Đơn giá (VNĐ)**

**MPN-1352**  
63A, 380-415V  
3P+N+E-IP67 **1.153.800**

**MPN-1452**  
125A, 380-415V  
3P+N+E-IP67 **2.702.700**

# Phích & Ổ cắm công nghiệp

## Cầu dao chống thấm nước IP66



Mã hàng Model	Số cực	Dòng điện (Ampe)	Điện áp (Voltage)	IP	Kích thước (AxBxC)mm	Đơn giá (VNĐ)
SW-120	1P	20A	250V	IP66	108x101x101	497.900
SW-132	1P	32A	250V	IP66	108x101x101	629.500
SW-220	2P	20A	250V	IP66	108x101x101	642.200
SW-232	2P	32A	250V	IP66	108x101x101	668.800
SW-263	2P	63A	250V	IP66	108x101x101	904.400
SW-320	3P	20A	500V	IP66	108x101x101	760.000
SW-332	3P	32A	500V	IP66	108x101x101	786.600
SW-350	3P	50A	500V	IP66	108x101x101	825.000
SW-363	3P	63A	500V	IP66	108x101x101	1.218.600

## Ổ cắm kết hợp công tắc 3 cực IP66



Mã hàng Model	Số cực	Dòng điện (Ampe)	Điện áp (Voltage)	IP	Kích thước (AxBxC)mm	Đơn giá (VNĐ)
S-315	2P+E	15A	250V	IP66	108x197x101	983.000
S-332	2P+E	32A	250V	IP66	108x197x101	1.232.400

## Phích Cắm Plug IP66



Mã hàng Model	Số cực	Dòng điện (Ampe)	Điện áp (Voltage)	IP	Kích thước (ØAxB)mm	Đơn giá (VNĐ)
P-315	2P+E	15A	250V	IP66	Ø 71x118	274.900
P-332	2P+E	32A	250V	IP66	Ø 78x180	655.500
MPN-C	Nút che ổ cắm công nghiệp loại bất tường					3.500

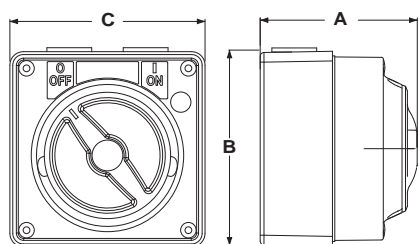

Cầu dao chống thấm nước IP66

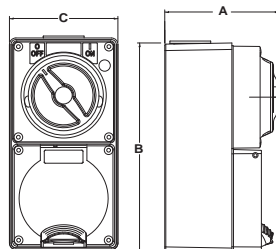

Ổ cắm kết hợp công tắc 3 cực IP66

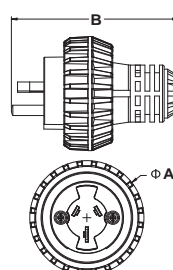

Phích Cắm Plug IP66 P-315

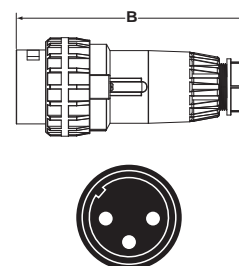

Phích Cắm Plug IP66 P-332

## Ổ cắm âm bàn

	Mã hàng	Diễn giải	Kích thước đọc lỗ (mm)	Kích thước bề mặt (mm)	Dây nguồn	Đơn giá (VNĐ)	
	<b>TBS1</b>	Ổ cắm âm bàn - 2 ổ cắm đa năng - 2 cổng kết nối USB - 2 cổng kết nối mạng	Dài: 222mm Rộng: 109mm Cao: 65mm	Dài: 264mm Rộng: 118mm	1800mm	<b>3.257.100</b>	
	<b>TBS2</b>	Ổ cắm âm bàn - 3 ổ cắm 3 chấu (2 chấu dẹp + 1 chấu tròn) - 2 cổng kết nối USB - 2 cổng kết nối mạng	Dài: 287mm Rộng: 132mm Cao: 79mm	Dài: 318mm Rộng: 159mm	1800mm	<b>3.003.000</b>	
	<b>TBS3</b>	Ổ cắm âm bàn - 1 ổ cắm 3 chấu (2 chấu dẹp + 1 chấu tròn) - 1 cổng kết nối USB - 1 cổng kết nối mạng - 1 bộ sạc không dây	Ø 80mm Cao: 69mm	Ø 96mm	1800mm	<b>3.453.500</b>	
	<b>TBS4</b>	Ổ cắm âm bàn - 3 ổ cắm 3 chấu (2 chấu dẹp + 1 chấu tròn) - 2 cổng kết nối USB - Có thể cắm phích từ 2 phía	Ø 100mm Cao: 222mm	Ø 115mm	1800mm	<b>2.656.500</b>	
	<b>TBS5</b>	Ổ cắm âm bàn - 3 ổ cắm 3 chấu (2 chấu dẹp + 1 chấu tròn) - 2 cổng kết nối USB - 2 cổng kết nối mạng	Ø 100mm Cao: 264mm	Ø 115mm	1800mm	<b>3.003.000</b>	
	<b>TBS6</b>	Ổ cắm âm bàn - 3 ổ cắm 3 chấu (2 chấu dẹp + 1 chấu tròn) - 2 cổng kết nối USB - Điều khiển ổ cắm nâng lên & hạ xuống bằng điện	Ø 92mm Cao: 420mm	Ø 110mm	2100mm	<b>10.247.300</b>	
	<b>FGP</b> (bao gồm đế)	Ổ cắm âm bàn - Kiểu tròn ,3 lỗ, bằng nhựa		Dài: 126mm Rộng: 126mm Cao: 50mm	Ø 135mm Cao: 5-30mm	-	<b>762.300</b>

# Ổ cắm âm sàn



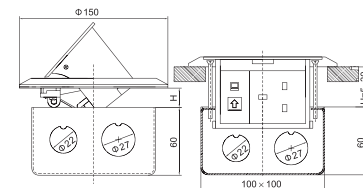
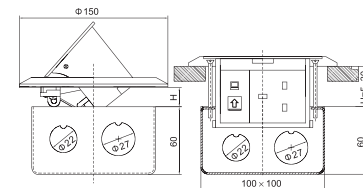
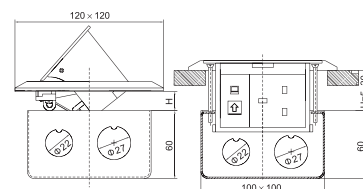
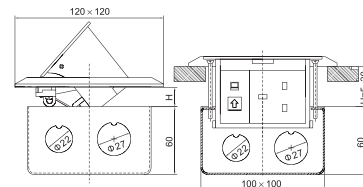



	Mã hàng	Diễn giải	Kích thước bề mặt (mm)	Kích thước âm sàn (mm)	Đơn giá (VNĐ)
	<b>FY-60</b>	Ổ cắm âm sàn - Kiểu vuông - Màu vàng - Không bao gồm đế	Dài: 120mm Rộng: 120mm Cao: 5-30mm	Dài: 100mm Rộng: 100mm Cao: 60mm	<b>855.900</b>
	<b>FA-60</b>	Ổ cắm âm sàn - Kiểu vuông - Màu xám - Không bao gồm đế	Dài: 120mm Rộng: 120mm Cao: 5-30mm	Dài: 100mm Rộng: 100mm Cao: 60mm	<b>855.900</b>
	<b>FCY-60</b>	Ổ cắm âm sàn - Kiểu tròn - Màu vàng - Không bao gồm đế	Ø 150mm Cao: 5-30mm	Dài: 100mm Rộng: 100mm Cao: 60mm	<b>855.900</b>
	<b>FCA-60</b>	Ổ cắm âm sàn - Kiểu tròn - Màu xám - Không bao gồm đế	Ø 150mm Cao: 5-30mm	Dài: 100mm Rộng: 100mm Cao: 60mm	<b>855.900</b>

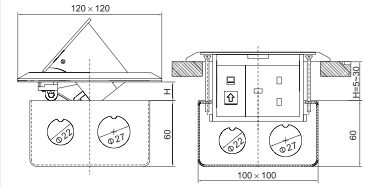
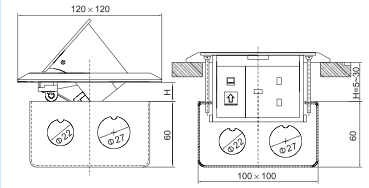





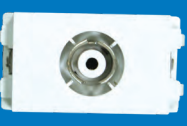

## Ổ cắm âm sàn và thiết bị rời A60

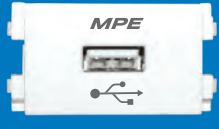
	Mã hàng	Diễn giải	Kích thước bề mặt (mm)	Kích thước âm sàn (mm)	Đơn giá (VNĐ)
	<b>F2Y-60</b>	Ổ cắm âm sàn - Kiểu vuông - Màu vàng - Mặt phẳng - Đóng mở êm - Không bao gồm đế	Dài: 120mm Rộng: 120mm Cao: 5-30mm	Dài: 100mm Rộng: 100mm Cao: 60mm	<b>855.900</b>
	<b>F2A-60</b>	Ổ cắm âm sàn - Kiểu vuông - Màu bạc - Mặt phẳng - Đóng mở êm - Không bao gồm đế	Dài: 120mm Rộng: 120mm Cao: 5-30mm	Dài: 100mm Rộng: 100mm Cao: 60mm	<b>855.900</b>













	Mã số / Diễn giải	Đơn giá (VNĐ)
	<b>A6USV</b> Ổ cắm 2 chấu	<b>32.400</b>
	<b>A6UESMV</b> Ổ cắm đa năng A60 (1.5 module)	<b>68.200</b>
	<b>A6UESM-2</b> Ổ cắm đa năng A60 (2 module)	<b>68.200</b>
	<b>A6UES2</b> Ổ cắm đôi 3 chấu	<b>81.800</b>
	<b>A6RJ64</b> Ổ cắm điện thoại 4 dây	<b>73.700</b>
	<b>A6RJ88</b> Ổ cắm mạng LAN 8 dây	<b>144.900</b>
	<b>A6TV75</b> Ổ cắm đồng trục TV loại 75 Ohm	<b>73.700</b>





	Mã số / Diễn giải	Đơn giá (VNĐ)
	<b>A6USB</b> Ổ cắm sạc USB DC 5V-2.1A	<b>306.100</b>
	<b>A6USB-A/C</b> Ổ cắm sạc USB Ổ cắm sạc USB C DC 5V-2.1A	<b>482.800</b>
	<b>A6NGNV</b> Đèn báo xanh	<b>38.800</b>
	<b>A6NRDV</b> Đèn báo đỏ	<b>38.800</b>
	<b>A6P</b> Nút che trơn	<b>5.100</b>
	<b>A6P2</b> Nút che trơn 1.5 module	<b>5.100</b>
	<b>F115</b> Đế sắt dùng cho ổ cắm âm sàn KT: 100x100x60 mm	<b>67.000</b>



## Ổ cắm du lịch, ổ cắm di động



	Mã số / Diễn giải	Đơn giá (VNĐ)
	<b>PL1</b> Phích cắm chân dẹp	<b>10.000</b>
	<b>PL2</b> Phích cắm 2 chấu tròn 4.5mm, 10A-250V	<b>19.100</b>
	<b>PL3</b> Phích cắm cái 10A-250V	<b>19.100</b>
	<b>AD1</b> Ổ cắm du lịch, chân cắm đẹp-tròn	<b>27.900</b>
	<b>AD2</b> Ổ cắm du lịch, 3 chân cắm kiểu Anh	<b>36.200</b>



	Mã số / Diễn giải	Đơn giá (VNĐ)
	<b>TA1</b> Ổ cắm du lịch	<b>107.500</b>
	<b>TA2</b> Ổ cắm du lịch, tích hợp cổng USB	<b>302.600</b>
	<b>TA3</b> Ổ cắm du lịch, tích hợp cổng USB	<b>242.600</b>
	<b>TA4</b> Ổ cắm du lịch đa năng 2 cổng USB	<b>313.100</b>
	<b>TA5</b> Ổ cắm du lịch đa năng chân cắm kiểu Châu Âu, Châu Úc, Châu Mỹ 2 sạc USB 3.4A	<b>693.000</b>





Dây Cáp	Mã số / Diễn giải	Đơn giá (VNĐ)
	<b>RG6-112</b> Cáp tivi 75 Ohm Lớp chống nhiễu 112 sợi Đóng gói: 305m/cuộn	<b>9.200</b>
	<b>TLC-2P</b> Cáp điện thoại 2 đôi (1/0.5mmx2P) đóng gói: 100m/cuộn 200m/cuộn	<b>6.500</b>
	<b>CAT5E-4P</b> Cáp mạng FTP 4 đôi Đóng gói: 305m/cuộn có giáp bạc chống nhiễu	<b>17.100</b>
	<b>CAT6E-4P</b> Cáp mạng FTP 4 đôi Đóng gói: 305m/cuộn có giáp bạc chống nhiễu	<b>26.000</b>

Băng Keo Điện	Mã số / Diễn giải	Đơn giá (VNĐ)
	<b>BKD-20</b> Băng keo điện P.V.C 0.12mmx19mmx20 yds - màu đen	<b>12.000</b>
	<b>BKW-20</b> Băng keo điện P.V.C 0.12mmx19mmx20 yds - màu trắng	<b>12.000</b>
	<b>BKG-20</b> Băng keo điện P.V.C 0.12mmx19mmx20 yds - màu xanh lá	<b>12.000</b>
	<b>BKY-20</b> Băng keo điện P.V.C 0.12mmx19mmx20 yds - màu vàng	<b>12.000</b>
	<b>BKR-20</b> Băng keo điện P.V.C 0.12mmx19mmx20 yds - màu đỏ	<b>12.000</b>

## Ổ cắm du lịch, ổ cắm di động

	Mã số / Diễn giải	Đơn giá (VNĐ)
	<b>AM6S1</b> Ổ cắm di động - 3 ổ cắm đôi 3 chấu	<b>460.800</b>
	<b>AM6S2</b> Ổ cắm di động - 3 ổ cắm đơn 2 chấu - 3 ổ cắm đơn đa năng 2.0	<b>460.800</b>

	Mã số / Diễn giải	Đơn giá (VNĐ)
	<b>AM6S3</b> Ổ cắm di động - 1 công tắc 2 cực 20A - 1 ổ cắm đôi 3 chấu - 2 ổ cắm đơn đa năng 1.5	<b>444.700</b>
	<b>AM6S4</b> Ổ cắm di động - 1 công tắc 1 chiều - 1 ổ cắm sạc USB + Type C - 1 ổ cắm đôi 3 chấu - 2 ổ cắm đơn đa năng 1.5	<b>1.019.700</b>

	Mã số / Diễn giải	Đơn giá (VNĐ)
	<b>AM2S-3USB</b> Ổ cắm di động - 2 ổ cắm đơn đa năng - 3 ổ cắm sạc USB	<b>456.500</b>
	<b>AM3S-2USB</b> Ổ cắm di động - 3 ổ cắm đa năng - 2 ổ cắm sạc USB 5VDC - 2.4A	<b>376.200</b>
	<b>AM4S-2USB</b> Ổ cắm di động - 4 ổ cắm đa năng - 2 ổ cắm sạc USB 5VDC - 2.4A	<b>409.200</b>
	<b>AM5S-2USB</b> Ổ cắm di động - 5 ổ cắm đa năng - 2 ổ cắm sạc USB 5VDC - 2.4A	<b>442.200</b>

	Mã số / Diễn giải	Đơn giá (VNĐ)
	<b>AM5S</b> Ổ cắm di động - 5 ổ cắm đơn đa năng	<b>264.400</b>
	<b>AMRL-10</b> Ổ cắm di động - 4 ổ cắm đơn đa năng - Dây dài 10m	<b>573.100</b>
	<b>AMRL-15</b> Ổ cắm di động - 4 ổ cắm đơn đa năng - Dây dài 15m	<b>746.900</b>





**New**



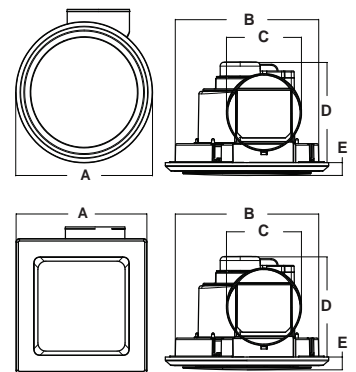

**Quạt hút tích hợp đèn LED downlight**

Seri AFCL	Mã hàng	Diễn giải	Đơn giá (VNĐ)
	AFCL-130R6	Quạt hút loại ốp trần Ceiling có đèn ■ Công suất tiêu thụ điện 30 Watt ■ Công suất hút gió 270m <sup>3</sup> /h ■ Điện thế 220-240 Volt ■ KT (AxBxCxDxE): 270x240x100x195x26mm ■ Kích thước đục lỗ trần 240mm ■ Dây nguồn dài 1000mm ■ Lỗ lắp đèn Ø90mm ■ Độ ồn 47dB	1.207.800
	AFCL-130R9		1.234.200
	AFCL-130S6		1.207.800
	AFCL-130S9		1.234.200



Seri DLC 3 màu	Mã hàng Model	Quang thông Lumens	Nhiệt độ màu CCT	Kích thước Size	Đục lỗ Cut out	Đóng gói Package	Đơn giá (VNĐ)
	DLC-6/3C	600 lm	6500K 4000K 3000K	Ø115x63mm	Ø90mm	1 cái/hộp 24 cái/thùng	221.800
	DLC-9/3C	900 lm	6500K 4000K 3000K	Ø115x63mm	Ø90mm	1 cái/hộp 24 cái/thùng	236.800

	Mã số / Diễn giải	Đơn giá (VNĐ)
	<p><b>AFC-130</b>  <b>Quạt hút loại ốp trần có mặt che bảo vệ</b></p> <ul style="list-style-type: none"> <li>■ Đường kính cánh quạt 120 mm</li> <li>■ Công suất tiêu thụ điện 25 Watt</li> <li>■ Công suất hút gió 2.0m<sup>3</sup>/min</li> <li>■ Điện thế 220 Volt</li> <li>■ KT (AxBxCxDxE): 200x235x245x28x100mm</li> <li>■ Kích thước đục lỗ trần 200x200mm</li> <li>■ Độ ồn 40 dB</li> </ul>	<p style="text-align: center;"><b>654.900</b></p>
	<p><b>AFC-250</b>  <b>Quạt hút loại ốp trần có mặt che bảo vệ</b></p> <ul style="list-style-type: none"> <li>■ Đường kính cánh quạt 160 mm</li> <li>■ Công suất tiêu thụ điện 33 Watt</li> <li>■ Công suất hút gió 2.9m<sup>3</sup>/min</li> <li>■ Điện thế 220 Volt</li> <li>■ KT (AxBxCxDxE): 250x302x312x28x100mm</li> <li>■ Kích thước đục lỗ trần 250x250mm</li> <li>■ Độ ồn 44 dB</li> </ul>	<p style="text-align: center;"><b>896.500</b></p>
	<p><b>AFC-300</b>  <b>Quạt hút loại ốp trần có mặt che bảo vệ</b></p> <ul style="list-style-type: none"> <li>■ Đường kính cánh quạt 180 mm</li> <li>■ Công suất tiêu thụ điện 42 Watt</li> <li>■ Công suất hút gió 3.1m<sup>3</sup>/min</li> <li>■ Điện thế 220 Volt</li> <li>■ KT (AxBxCxDxE): 292x330x340x37x100mm</li> <li>■ Kích thước đục lỗ trần 292x292mm</li> <li>■ Độ ồn 46 dB</li> </ul>	<p style="text-align: center;"><b>1.096.700</b></p>

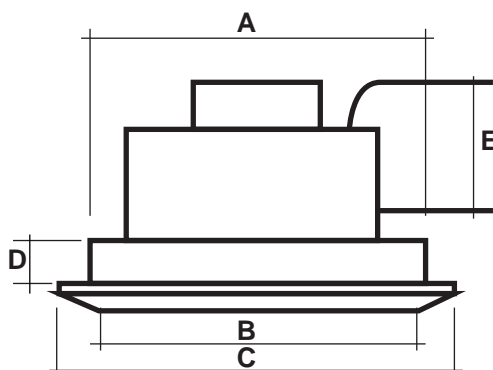

	Mã số / Diễn giải	Đơn giá (VNĐ)
	<p><b>AF-150</b></p> <p>Quạt hút loại ốp tường có mặt che bảo vệ</p> <ul style="list-style-type: none"> <li>■ Đường kính cánh quạt 150 mm</li> <li>■ Công suất tiêu thụ điện 25 Watt</li> <li>■ Công suất hút gió 4.8m<sup>3</sup>/min</li> <li>■ Điện thế 220 Volt</li> <li>■ KT (AxBxCxDxE): 150x235x183x80x61mm</li> <li>■ Kích thước đục lỗ trần 200x200mm</li> <li>■ Độ ồn 43 dB</li> </ul>	<p style="text-align: center;"><b>597.800</b></p>
	<p><b>AF-200</b></p> <p>Quạt hút loại ốp tường có mặt che bảo vệ</p> <ul style="list-style-type: none"> <li>■ Đường kính cánh quạt 200 mm</li> <li>■ Công suất tiêu thụ điện 30 Watt</li> <li>■ Công suất hút gió 8.1m<sup>3</sup>/min</li> <li>■ Điện thế 220 Volt</li> <li>■ KT (AxBxCxDxE): 200x290x230x83x61mm</li> <li>■ Kích thước đục lỗ trần 250x250mm</li> <li>■ Độ ồn 46 dB</li> </ul>	<p style="text-align: center;"><b>717.300</b></p>
	<p><b>AF-250</b></p> <p>Quạt hút loại ốp tường có mặt che bảo vệ</p> <ul style="list-style-type: none"> <li>■ Đường kính cánh quạt 250 mm</li> <li>■ Công suất tiêu thụ điện 35 Watt</li> <li>■ Công suất hút gió 12.6m<sup>3</sup>/min</li> <li>■ Điện thế 220 Volt</li> <li>■ KT (AxBxCxDxE): 250x335x280x83x61mm</li> <li>■ Kích thước đục lỗ trần 305x305mm</li> <li>■ Độ ồn 48 dB</li> </ul>	<p style="text-align: center;"><b>790.400</b></p>

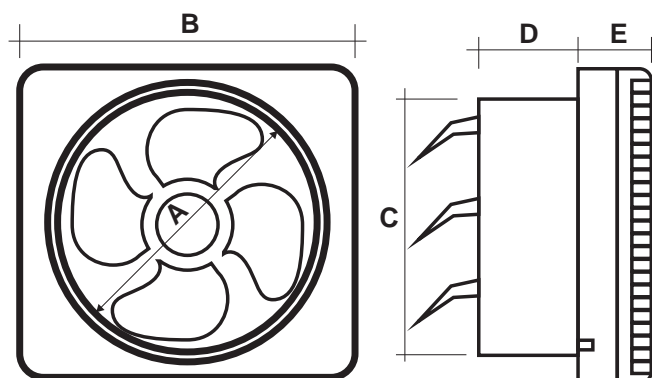

# HỆ THỐNG ĐIỀU KHIỂN THÔNG MINH MPE SMART CONTROL

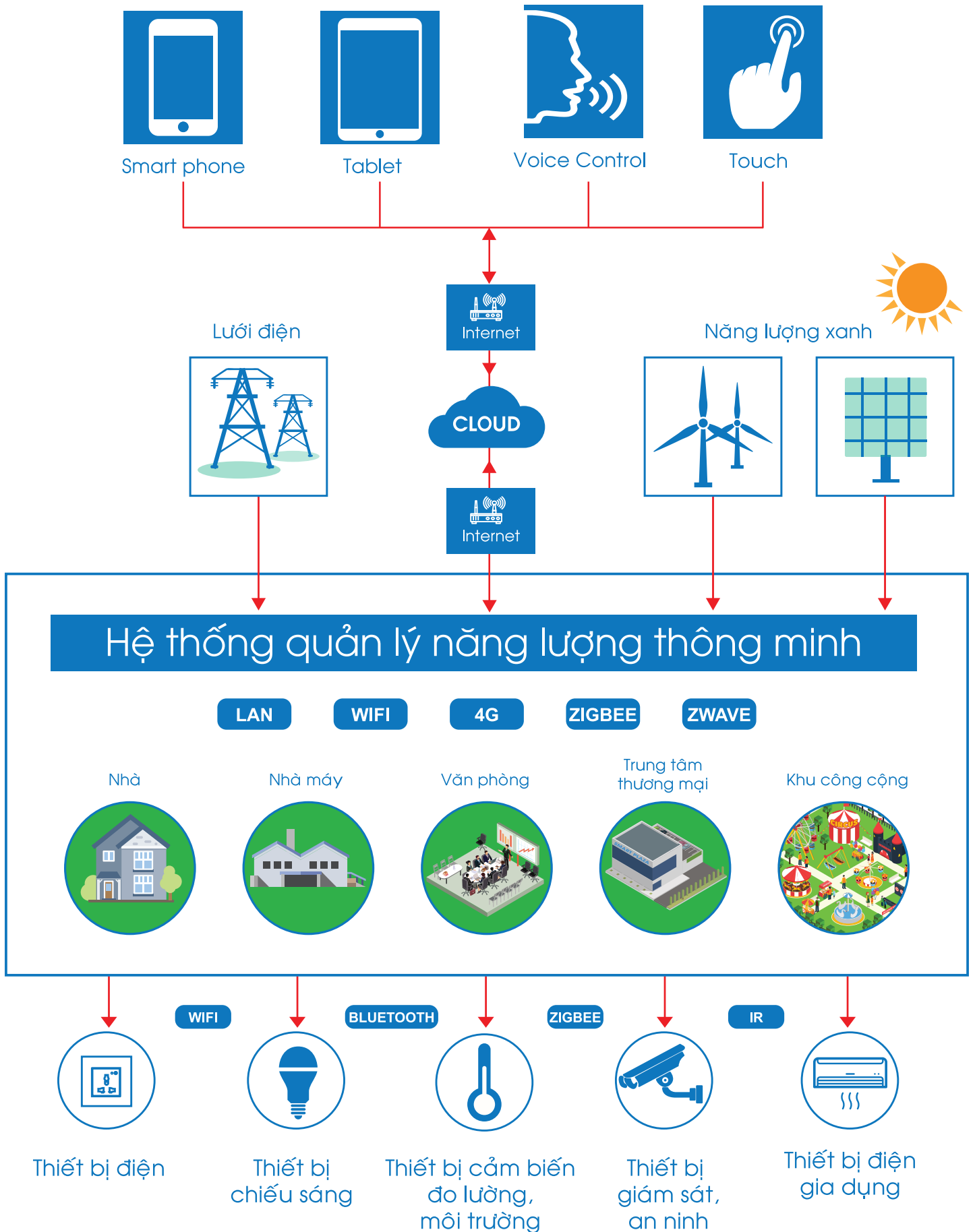

# HƯỚNG DẪN CÀI ĐẶT VÀ ĐĂNG NHẬP SMART CB (CB THÔNG MINH)

1. Bấm và giữ nút “Wifi Hotspot” trên Module điều khiển trong 10 giây.
2. Kết nối Wifi của CB phát ra và nhập mật khẩu mặc định là 88888888.
3. Mở ứng dụng MPE Smart Breaker và nhập địa chỉ Mac được in trên Module mạng của CB.
  - Mật khẩu (mặc định): admin
  - Đặt tên thiết bị và lưu.
  - Kiểm tra số lượng CB hiển thị trên ứng dụng:
    - + Nếu số lượng CB không đúng với thực tế làm bước 4.
    - + Nếu số lượng CB đúng với thực tế bỏ qua bước 4 làm bước 5.
4. Chọn mục:
  - Điều khiển → Cài đặt thông số → Set up → Cài đặt địa chỉ → Tắt tất cả các CB và chọn “Bắt Đầu”.
  - Nhấn và giữ nút On/Off (màu cam) trên CB (nên ưu tiên trên CB tổng) cho đến khi đèn sáng nhấp nháy.
  - Chọn kết thúc.
5. Nhấp vào dấu “+” góc phải màn hình
  - Chọn mạng Wifi muốn kết nối.
  - Sửa đổi mật khẩu và chọn múi giờ, thời gian.  
(múi giờ GMT + 07:00 - Asian/Ho\_Chi\_Minh)
6. Trở về màn hình chính (nhấn vào biểu tượng  trên màn hình)
7. Vào mục điều khiển để điều khiển các CB.

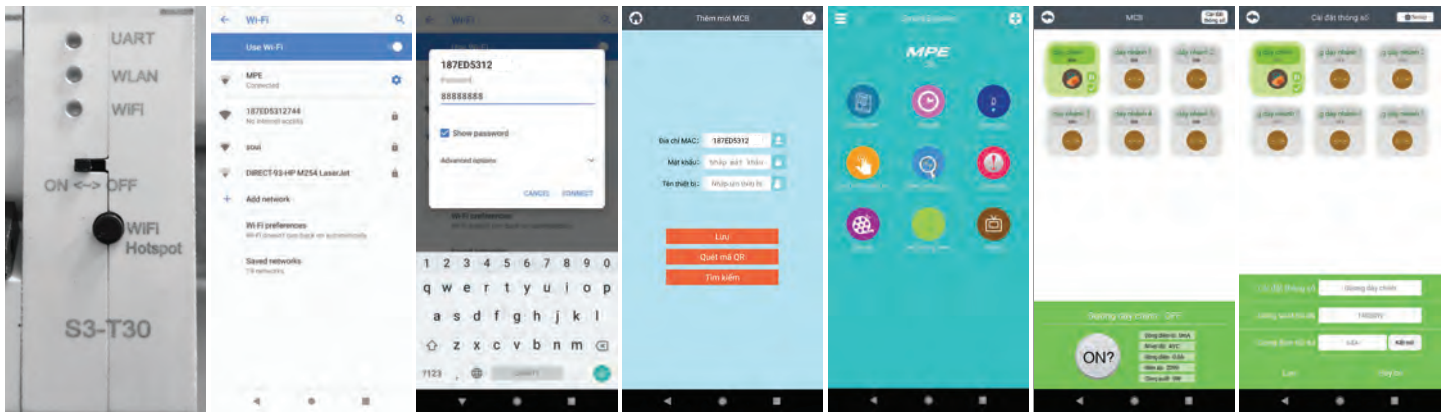

Bước 1

Bước 2.1

Bước 2.2

Bước 3

Bước 4.1

Bước 4.2

Bước 4.3

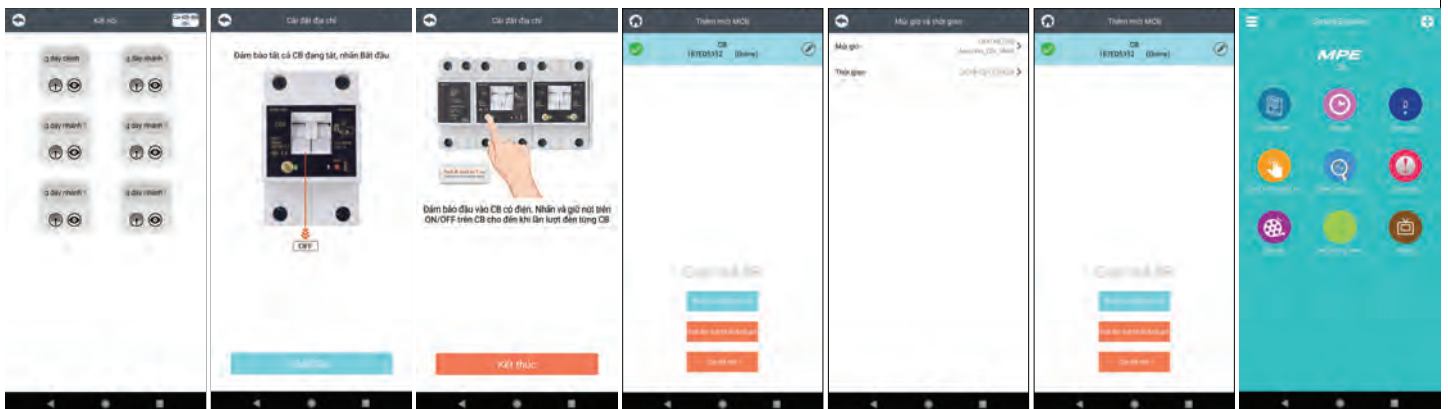

Bước 4.4

Bước 4.5

Bước 4.6

Bước 5.1

Bước 5.2

Bước 6

Bước 7

# HỆ THỐNG QUẢN LÝ NĂNG LƯỢNG THÔNG MINH

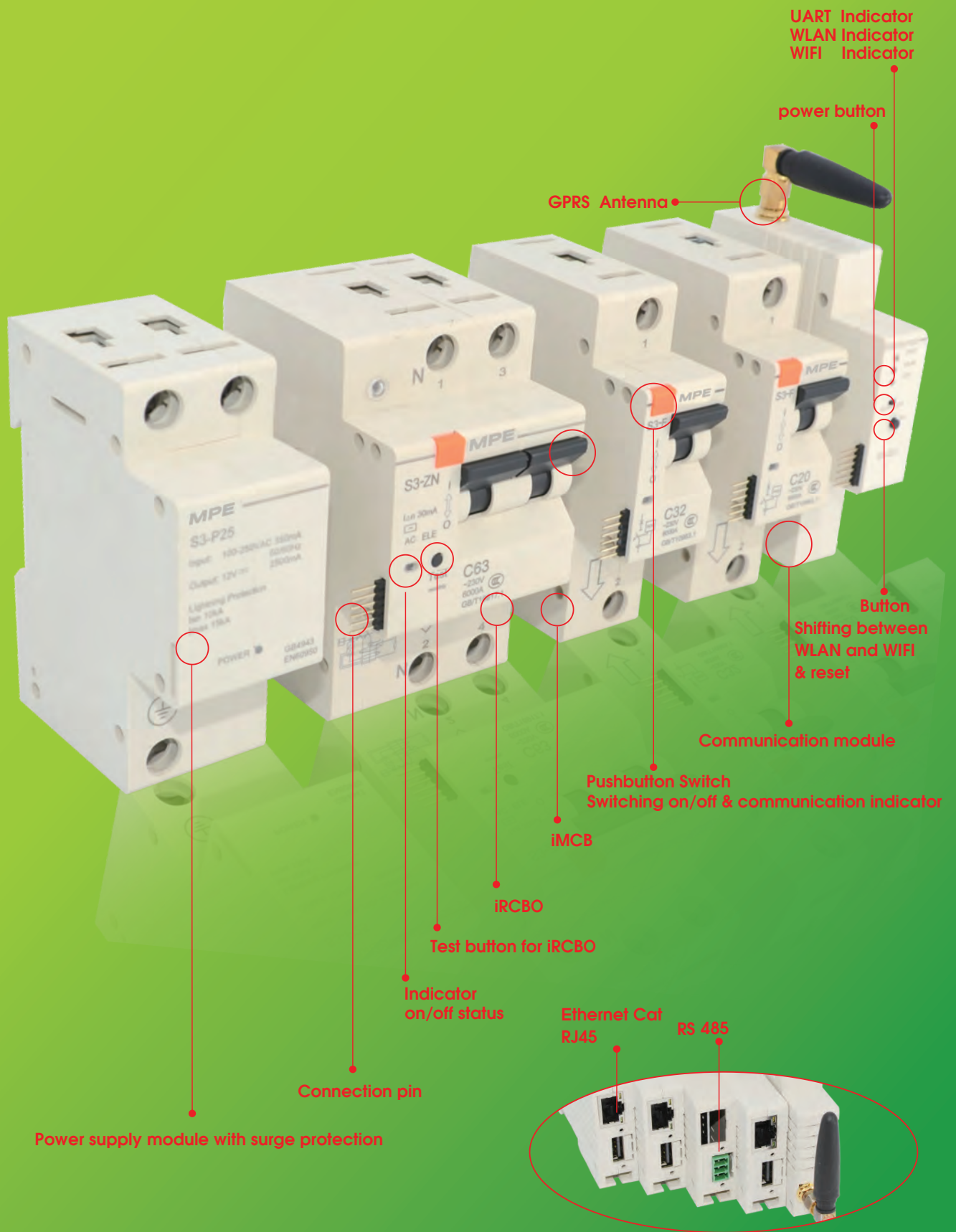





## Hệ thống quản lý năng lượng thông minh

### MCB 1P, 2P, 3P, 4P

	Mã hàng Model	Số cực	Dòng định mức In (A)	Icu (kA)	Đơn giá (VNĐ)
	MCBS-120 (1+20A)	1P	20A	6kA	1.731.400
	MCBS-132 (1+32A)	1P	32A	6kA	1.731.400
	MCBS-163 (1+63A)	1P	63A	6kA	1.731.400
	MCBS-232 (1+32A)	2P	32A	6kA	4.363.600
	MCBS-263 (1+63A)	2P	63A	6kA	4.363.600
	MCBS-280 (1+80A)	2P	80A	6kA	4.363.600
	MCBS-332 (1+32A)	3P	32A	6kA	6.615.800
	MCBS-363 (1+63A)	3P	63A	6kA	6.615.800
	MCBS-380 (1+80A)	3P	80A	6kA	6.615.800
	MCBS-432 (1+32A)	4P	32A	6kA	7.727.000
	MCBS-463 (1+63A)	4P	63A	6kA	7.727.000
	MCBS-480 (1+80A)	4P	80A	6kA	7.727.000

### Cầu dao chống giật (RCBO)

	Mã hàng Model	Số cực	Dòng định mức In (A)	Dòng rò I <sub>Δn</sub> (mA)	Icu (kA)	Đơn giá (VNĐ)
	RCBOS-232/30	2P	32A	30mA	6kA	4.585.400
	RCBOS-263/30	2P	63A	30mA	6kA	4.585.400
	RCBOS-280/30	2P	80A	30mA	6kA	4.585.400
	RCBOS-432/30	4P	32A	30mA	6kA	8.257.200
	RCBOS-463/30	4P	63A	30mA	6kA	8.257.200
	RCBOS-480/30	4P	80A	30mA	6kA	8.257.200

## Module cung cấp nguồn điện DC ổn định cho thiết bị đóng ngắt thông minh

### PSS-25, PSS-25D



Mã hàng Model	Điện áp vào In put	Điện áp ra Out put	Dòng điện Ampe	Đơn giá (VNĐ)
<b>PSS-25</b> Bộ cấp nguồn	110-265 VAC	12 VDC	2.5A	<b>1.731.400</b>
<b>PSS-25D</b> Bộ cấp nguồn	110-265 VAC	12 VDC	2.5A	<b>2.077.900</b>

### Module cung cấp nguồn điện Wifi, 4G, Zigbee



Mã hàng Model	Điện áp vào In put	Đơn giá (VNĐ)
<b>MD-WF</b> (Module Wifi)	12 VDC	<b>2.617.200</b>
<b>MD-WF/4G</b> (Module Sim 4G)	12 VDC	<b>4.905.300</b>
<b>MD-ZB</b> (Module Zigbee)	12 VDC	<b>1.357.200</b>

### Chân cắm/ Cáp nối

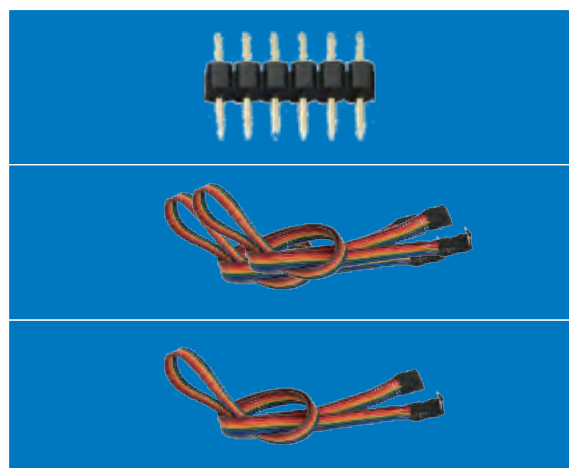

Mã hàng Model	Sản phẩm	Kiểu dáng	Đơn giá (VNĐ)
<b>PKMS-P6</b>	Chân cắm Pin	6 Pin	<b>3.500</b>
<b>PKMS-CT50</b>	Cáp nối	50 cm	<b>277.200</b>
<b>PKMS-CT80</b>	Cáp nối	80 cm	<b>519.800</b>

## Tủ điện seri TS

Tủ Điện Seri TS	Mã hàng Model	Số cực	Kích thước (AxBxCxDxH1xH2)mm	Đơn giá (VNĐ)
	Tủ TS-4	2-4	148x160x128x148x90x70	<b>162.900</b>
	Tủ TS-6	5-6	200x216x180x190x90x70	<b>216.000</b>
	<b>New</b> Tủ TS-10	7-10	290x217x267x185x90x70	<b>336.000</b>
	Tủ TS-12	10-12	311x248x286x226x90x70	<b>346.500</b>
	Tủ TS-14	11-14	349x248x326x228x90x70	<b>450.500</b>
	Tủ TS-20	15-20	468x248x434x228x96x76	<b>680.400</b>
	Tủ TS-24	21-24	311x404x290x385x96x76	<b>970.200</b>
	Tủ TS-32	25-32	396x496x372x475x96x76	<b>1.192.000</b>
	Tủ TS-40	33-40	468x496x443x475x96x76	<b>1.375.700</b>
	Tủ TS-48	41-48	395x745x371x724x96x76	<b>2.574.000</b>
	Tủ TS-60	49-60	468x745x444x724x96x76	<b>3.289.000</b>

### Kích Thước Tủ Điện

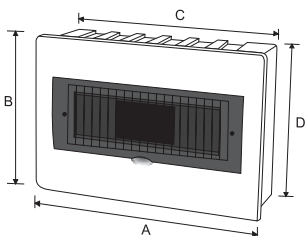



Phần thanh ray có thể thay đổi hướng lắp đặt



Thanh dẫn điện bằng đồng

## Tủ điện seri TN + seri WP (chống thấm nước)

Tủ Điện Seri TN - IP30	Mã hàng Model	Số cực	Kích thước (LxHxW)mm	Đơn giá (VNĐ)
	Tủ TN-2	1-2	66x125x85 mm	<b>60.500</b>
	Tủ TN-4	3-4	93x124x85 mm	<b>78.100</b>

Tủ Điện chống thấm Seri WP - IP65	Mã hàng Model	Số cực	Kích thước (LxHxW)mm	Đơn giá (VNĐ)
	Tủ WP-4	2-4	107x212x92 mm	<b>750.800</b>
	Tủ WP-6	5-6	165x200x100 mm	<b>935.600</b>
	Tủ WP-9	7-9	219x200x100 mm	<b>1.150.400</b>
	Tủ WP-12	10-12	273x230x110 mm	<b>1.556.900</b>
	Tủ WP-18	13-18	381x230x110 mm	<b>2.106.700</b>
	Tủ WP-24	19-24	273x380x110 mm	<b>2.743.200</b>
	Tủ WP-36	25-36	381x380x110 mm	<b>3.768.800</b>

## Hướng dẫn kết nối thiết bị thông minh với MPE Smart Control

### 1. Cài đặt ứng dụng MPE SMART CONTROL

- Quét mã QR hoặc tìm kiếm ứng dụng MPE SMART CONTROL trên CH Play / App Store.
- Đăng ký tài khoản, đọc kỹ và đồng ý các chính sách ứng dụng.
- Chọn quốc gia, nhập email. Hệ thống sẽ gửi mã xác minh vào email mà bạn đăng ký.
- Tạo mật khẩu cho tài khoản.  
(Lưu ý mật khẩu bao gồm cả chữ và số từ 6 đến 20 kí tự).

### 2. Kết nối thiết bị thông minh với MPE Smart Control

**B1:** Nhấn giữ nút nguồn của thiết bị khoảng 5 giây (ổ cắm, công tắc thông minh, cảm biến,...) hoặc “Tắt và Mở” nguồn điện 3 lần liên tục (đèn thông minh, thiết bị không có nút nguồn,...) cho đến khi đèn báo nhấp nháy nhanh 2 lần/giây.





- Nếu đèn báo nhấp nháy chậm 3 giây/lần thì ngắt thiết bị ra khỏi nguồn điện, đợi 10 giây cấp nguồn điện lại và thực hiện lại B1.

**B2:** Nhấp vào biểu tượng “+” tại góc phải trên cùng MPE Smart Control, chọn thiết bị tương ứng và làm theo hướng dẫn. Trường hợp bạn không tìm thấy thiết bị tương ứng, vui lòng chọn mục “Sản phẩm khác”.







## Ổ Cắm Thông Minh Điều Khiển Wifi

	Mã hàng Model	Công suất Watt	Dòng điện Ampe	Kết nối Wifi	Kích thước Size	Đóng gói Package	Đơn giá (VNĐ)
	SWP15-1	2000W	15A	2.4Ghz, 1T1R	75x37.5x30 mm	1 cái/hộp 200 cái/thùng	508.200
	SWP16-2	2000W	16A	2.4Ghz, 1T1R	85x40x30 mm	1 cái/hộp 200 cái/thùng	559.000
	SWP16-3	2000W	16A	2.4Ghz, 1T1R	85x42x34 mm	1 cái/hộp 200 cái/thùng	559.000
	SWP16-5	2000W	16A+2USB2.4A	2.4Ghz, 1T1R	85x42x34 mm	1 cái/hộp 200 cái/thùng	669.900

## Ổ Cắm Di Động Thông Minh Điều Khiển Wifi

	Mã hàng Model	Công suất USB	Dòng điện Ampe	Kết nối Wifi	Kích thước Size	Đóng gói Package	Đơn giá (VNĐ)
	SPS1	5V 2.1A	15A	2.4Ghz	335x65x40 mm	1 cái/hộp 20 cái/thùng	1.231.200

## Đèn Ngủ Thông Minh Điều Khiển Wifi





	Mã hàng Model	Công suất Watt	Điện áp VAC	Tần số Hz	Kích thước Size	Đóng gói Package	Đơn giá (VNĐ)
	BHS2/SC	1-9W	220VAC	50Hz	270x270x500 mm	1 cái/hộp 12 cái/thùng	2.246.500

## Đèn Bàn Thông Minh Điều Khiển Wifi

	Mã hàng Model	Công suất Watt	Quang thông Lumens	Nhiệt độ màu CCT	Tần số Hz	Điện áp VAC	Đơn giá (VNĐ)
	TL4/SC	10W	600Lm	2700-6000K	50Hz	220VAC	2.772.000

# Công tắc thông minh điều khiển Wifi viền vàng - bạc

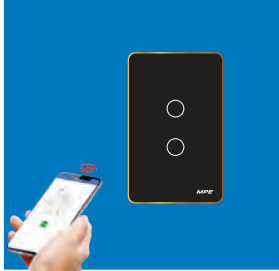
New

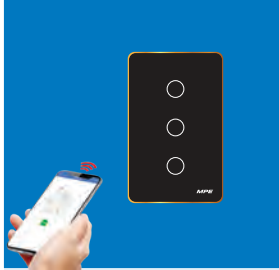
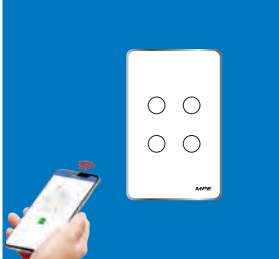
Công Tắc Thông Minh Điều Khiển Wifi	Mã số / Diễn giải	Đơn giá (VNĐ)	Công Tắc Thông Minh Điều Khiển Wifi	Mã số / Diễn giải	Đơn giá (VNĐ)
	<b>SWW1/SC</b> Mặt 1 công tắc màu trắng viền bạc - KT: 120x72x43 mm - Tải định mức: 1000W/gang (LED: 200W max/gang)	<b>840.600</b>		<b>SWB1/SC</b> Mặt 1 công tắc màu đen viền vàng - KT: 120x72x43 mm - Tải định mức: 1000W/gang (LED: 200W max/gang)	<b>840.600</b>
	<b>SWW2/SC</b> Mặt 2 công tắc màu trắng viền bạc - KT: 120x72x43 mm - Tải định mức: 1000W/gang (LED: 200W max/gang)	<b>935.400</b>		<b>SWB2/SC</b> Mặt 2 công tắc màu đen viền vàng - KT: 120x72x43 mm - Tải định mức: 1000W/gang (LED: 200W max/gang)	<b>935.400</b>
	<b>SWW3/SC</b> Mặt 3 công tắc màu trắng viền bạc - KT: 120x72x43 mm - Tải định mức: 1000W/gang (LED: 200W max/gang)	<b>995.700</b>		<b>SWB3/SC</b> Mặt 3 công tắc màu đen viền vàng - KT: 120x72x43 mm - Tải định mức: 1000W/gang (LED: 200W max/gang)	<b>995.700</b>
	<b>SWW4/SC</b> Mặt 4 công tắc màu trắng viền bạc - KT: 120x72x43 mm - Tải định mức: 1000W/gang (LED: 200W max/gang)	<b>1.064.700</b>		<b>SWB4/SC</b> Mặt 4 công tắc màu đen viền vàng - KT: 120x72x43 mm - Tải định mức: 1000W/gang (LED: 200W max/gang)	<b>1.064.700</b>

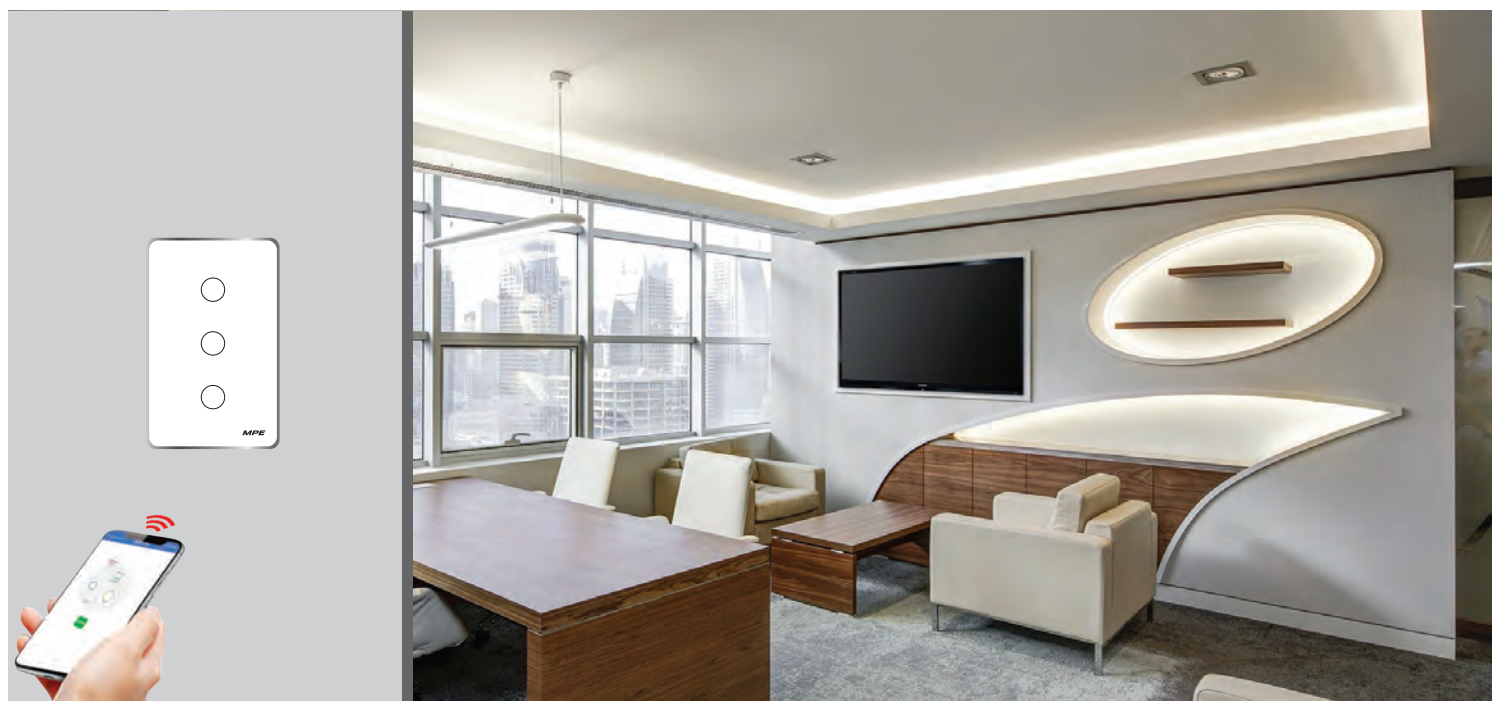

## Thiết bị công tắc - Ổ cắm thông minh điều khiển Wifi

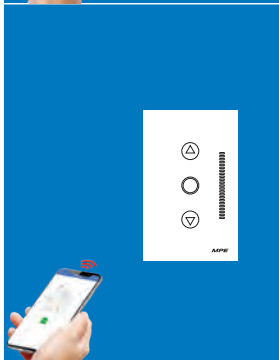
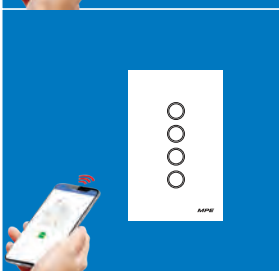
Công Tắc Thông Minh Điều Khiển Wifi		Mã số / Diễn giải	Đơn giá(VNĐ)	Công Tắc Thông Minh Điều Khiển Wifi		Mã số / Diễn giải	Đơn giá(VNĐ)
	<b>SW1/SC</b> Mặt 1 công tắc - KT: 120x72x43 mm - Tải định mức: 1000W/gang - LED: 150W max/gang		<b>980.700</b>		<b>CSW/SC</b> Công tắc rèm cửa - KT: 120x72x43 mm - Tải định mức: 1000W/gang		<b>1.195.500</b>
	<b>SW2/SC</b> Mặt 2 công tắc - KT: 120x72x43 mm - Tải định mức: 1000W/gang - LED: 150W max/gang		<b>1.058.000</b>		<b>DIM1/SC</b> Dimmer đèn - KT: 120x72x43 mm - Tải định mức: 1000W/gang,		<b>1.446.100</b>
	<b>SW3/SC</b> Mặt 3 công tắc - KT: 120x72x43 mm - Tải định mức: 1000W/gang - LED: 150W max/gang		<b>1.140.000</b>		<b>S02/SC</b> Ổ cắm đôi 3 chấu - KT: 120x72x43 mm - 16A		<b>1.366.400</b>
	<b>SW4/SC</b> Mặt 4 công tắc - KT: 120x72x43 mm - Tải định mức: 1000W/gang - LED: 150W max/gang		<b>1.491.200</b>				
	<b>Mã số / Diễn giải</b>		<b>Đơn giá(VNĐ)</b>		<b>Mã số / Diễn giải</b>		<b>Đơn giá(VNĐ)</b>
	<b>MAT1/SC</b> Mặt 1 lỗ, dùng cho thiết bị rời A30 - KT: 115x72x43mm		<b>136.300</b>		<b>MAT3/SC</b> Mặt 3 lỗ, dùng cho thiết bị rời A30 - KT: 115x72x43mm		<b>190.600</b>
	<b>MAT2/SC</b> Mặt 2 lỗ, dùng cho thiết bị rời A30 - KT: 115x72x43mm		<b>164.000</b>				



## Thiết bị công tắc - ổ cắm thông minh điều khiển Wifi & Zigbee

Công Tắc Thông Minh Điều Khiển Wifi	Mã số / Diễn giải	Đơn giá(VNĐ)	Công Tắc Thông Minh Điều Khiển Wifi	Mã số / Diễn giải	Đơn giá(VNĐ)
	<b>SWV1/SC</b> Mặt 1 công tắc - KT: 86 x 86 mm - Tải định mức: 700W/gang - LED: 150W max/gang	<b>980.700</b>		<b>SWV3/SC</b> Mặt 3 công tắc - KT: 86 x 86 mm - Tải định mức: 700W/gang - LED: 150W max/gang	<b>1.140.000</b>
	<b>SWV2/SC</b> Mặt 2 công tắc - KT: 86 x 86 mm - Tải định mức: 700W/gang - LED: 150W max/gang	<b>1.058.000</b>		<b>SOMV/SC</b> Mặt ổ cắm đa năng - KT: 86 x 86 mm - Tải định mức: 16A	<b>1.084.600</b>
Công Tắc Thông Minh Điều Khiển Zigbee	Mã số / Diễn giải	Đơn giá(VNĐ)	Công Tắc Thông Minh Điều Khiển Zigbee	Mã số / Diễn giải	Đơn giá(VNĐ)
	<b>SW1/ZB</b> Mặt 1 công tắc - KT: 120x72x43 mm - Tải định mức: 500W/gang	<b>1.255.100</b>		<b>SWV1/ZB</b> Mặt 1 công tắc - KT: 86 x 86 mm - Tải định mức: 500W/gang	<b>1.255.100</b>
	<b>SW2/ZB</b> Mặt 2 công tắc - KT: 120x72x43 mm - Tải định mức: 500W/gang	<b>1.375.000</b>		<b>SWV2/ZB</b> Mặt 2 công tắc - KT: 86 x 86 mm - Tải định mức: 500W/gang	<b>1.375.000</b>
	<b>SW3/ZB</b> Mặt 3 công tắc - KT: 120x72x43 mm - Tải định mức: 500W/gang	<b>1.474.000</b>		<b>SWV3/ZB</b> Mặt 3 công tắc - KT: 86 x 86 mm - Tải định mức: 500W/gang	<b>1.474.000</b>

# Đèn LED Thông Minh Điều Khiển Wifi



LED Bulb Điều Khiển Wifi	Mã hàng Model	Quang thông Lumens	Nhiệt độ màu CCT	Kích thước Size	Đui đèn Base	Đóng gói Package	Đơn giá (VNĐ)
	LB-9/SC	806 Lm	2700 - 6500K RGB	60x118 mm	E27	1 cái/hộp 100 cái/thùng	<b>481.700</b>
	LB-13/SC	1200 Lm	2700 - 6500K RGB	95x135 mm	E27	1 cái/hộp 10 cái/thùng	<b>594.900</b>
	LB-20/SC	1800 Lm	2700 - 6500K RGB	100x185 mm	E27	1 cái/hộp 20 cái/thùng	<b>829.300</b>
	LB-30/SC	2700 Lm	2700 - 6500K RGB	118x210 mm	E27	1 cái/hộp 12 cái/thùng	<b>1.051.100</b>
	LB-40/SC	3600 Lm	2700 - 6500K RGB	135x238 mm	E27	1 cái/hộp 8 cái/thùng	<b>1.182.700</b>
	LB-50/SC	4500 Lm	2700 - 6500K RGB	135x238 mm	E27	1 cái/hộp 8 cái/thùng	<b>1.615.900</b>

LED Bulb Dây Tóc Điều Khiển Wifi	Mã hàng Model	Quang thông Lumens	Nhiệt độ màu CCT	Kích thước Size	Đui đèn Base	Đóng gói Package	Đơn giá (VNĐ)
	FLM-6/A60SC	600 Lm	3000K	60x105 mm	E27	1 cái/hộp 50 cái/thùng	<b>398.500</b>
	FLM-6/G95SC	600 Lm	3000K	95x140 mm	E27	1 cái/hộp 20 cái/thùng	<b>444.700</b>
	FLM-6/ST64SC	600 Lm	3000K	64x140 mm	E27	1 cái/hộp 20 cái/thùng	<b>421.600</b>

# Đèn LED Âm Trần WIFI - ZIGBEE











## Panel Tròn Âm Wifi - Zigbee

	Mã hàng Model	Quang thông Lumens	Nhiệt độ màu CCT	Kích thước Size	Đục lỗ Cut out	Đóng gói Package	Đơn giá (VNĐ)
	RPL-6/SC	500 Lm	2700-6500K RGB	Ø120x25 mm	Ø 105 mm	1 cái/hộp 60 cái/thùng	<b>1.098.900</b>
	RPL-6/ZB						
	RPL-9/SC	750 Lm	2700-6500K RGB	Ø150x25 mm	Ø 130	1 cái/hộp 40 cái/thùng	<b>1.166.000</b>
	RPL-9/ZB						
	RPL-12/SC	950 Lm	2700-6500K RGB	Ø170x25 mm	Ø 150	1 cái/hộp 40 cái/thùng	<b>1.276.000</b>
	RPL-12/ZB						
	RPL-18/SC	1500 Lm	2700-6500K RGB	Ø225x25 mm	Ø 205 mm	1 cái/hộp 20 cái/thùng	<b>1.454.200</b>
	RPL-18/ZB						
	RPL-24/SC	1800 Lm	2700-6500K RGB	Ø300x25 mm	Ø 280 mm	1 cái/hộp 10 cái/thùng	<b>1.837.000</b>
	RPL-24/ZB						

# Đèn LED Ốp Trần WIFI - ZIGBEE



## Panel Tròn Nổi Wifi - Zigbee

	Mã hàng Model	Quang thông Lumens	Nhiệt độ màu CCT	Kích thước Size	PF	Đóng gói Package	Đơn giá (VNĐ)
  <b>6W</b>	SRPL-6/SC	480 Lm	2700-6500K RGB	Ø 217x35 mm	>0.5	1 cái/hộp 20 cái/thùng	<b>1.166.000</b>
	SRPL-6/ZB						
  <b>12W</b>	SRPL-12/SC	950 Lm	2700-6500K RGB	Ø 170x35 mm	>0.5	1 cái/hộp 30 cái/thùng	<b>1.353.000</b>
	SRPL-12/ZB						
  <b>18W</b>	SRPL-18/SC	1500 Lm	2700-6500K RGB	Ø 217x35 mm	>0.5	1 cái/hộp 20 cái/thùng	<b>1.573.000</b>
	SRPL-18/ZB						
  <b>24W</b>	SRPL-24/SC	1800 Lm	2700-6500K RGB	Ø 300x35 mm	>0.5	1 cái/hộp 10 cái/thùng	<b>1.984.400</b>
	SRPL-24/ZB						

# Đèn LED Ốp Trần WIFI - ZIGBEE



## LED Tấm Thông Minh Điều Khiển Wifi - Zigbee

	Mã hàng Model	Quang thông Lumens	Nhiệt độ màu CCT	Kích thước Size	PF	Đóng gói Package	Đơn giá (VNĐ)
  <b>20W</b>	FPL-3030/SC	1800 Lm	2700-6500K RGB	300x300x11 mm	>0.9	1 cái/hộp 10 cái/thùng	<b>2.142.600</b>
	<b>New</b> FPL-3030/ZB						
  <b>25W</b>	FPL-6030/SC	2250 Lm	2700-6500K RGB	600x300x11 mm	>0.9	1 cái/hộp 5 cái/thùng	<b>2.528.400</b>
	<b>New</b> FPL-6030/ZB						
  <b>40W</b>	FPL-6060/SC	3600 Lm	2700-6500K RGB	600x600x11 mm	>0.9	1 cái/hộp 5 cái/thùng	<b>3.411.900</b>
	<b>New</b> FPL-6060/ZB						
  <b>40W</b>	FPL-12030/SC	3600 Lm	2700-6500K RGB	1200x300x11 mm	>0.9	1 cái/hộp 5 cái/thùng	<b>4.233.100</b>
	<b>New</b> FPL-12030/ZB						

# Đèn LED Thông Minh Điều Khiển Wifi



## LED Bán Nguyệt Điều Khiển Wifi

	Mã hàng Model	Quang thông Lumens	Nhiệt độ màu CCT	Góc chiếu Angle	Kích thước Size	Đóng gói Package	Đơn giá (VNĐ)
	<b>BN-18/SC</b>	1800Lm	2700-6500K RGB	120°	600x74x24 mm	1 cái/hộp 12 cái/thùng	<b>1.247.400</b>
	<b>BN-36/SC</b>	3600Lm	2700-6500K RGB	120°	1200x74x24 mm	1 cái/hộp 12 cái/thùng	<b>2.032.800</b>

## LED Ốp Trần Ceiling Điều Khiển Wifi

	Mã hàng Model	Công suất Watt	Quang thông Lumens	Nhiệt độ màu CCT	Kích thước Size	Đóng gói Package	Đơn giá (VNĐ)
	<b>CL-20/SC</b>	20W	2000 Lm	2700-6500K RGB	Ø300x85 mm	1 cái/hộp 5 cái/thùng	<b>1.153.900</b>
	<b>CL-30/SC</b>	30W	3000 Lm	2700-6500K RGB	Ø350x85 mm	1 cái/hộp 5 cái/thùng	<b>1.542.000</b>

## Viên Đèn Ceiling

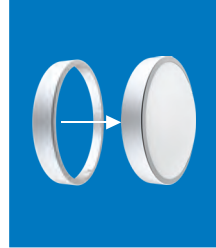
	Mã số / Diễn giải	Đơn giá (VNĐ)
	<b>BD30-W</b> Màu trắng (White) 20W	<b>206.800</b>
	<b>BD35-W</b> Màu trắng (White) 30W	<b>244.900</b>
	<b>BD30-S</b> Màu xám bạc (Silver) 20W	<b>206.800</b>
	<b>BD35-S</b> Màu xám bạc (Silver) 30W	<b>244.900</b>
	<b>BD30-C</b> Màu crôm (Chromi) 20W	<b>206.800</b>
	<b>BD35-C</b> Màu crôm (Chromi) 30W	<b>244.900</b>

## Viên Đèn Ceiling

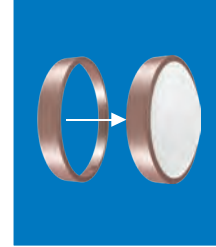
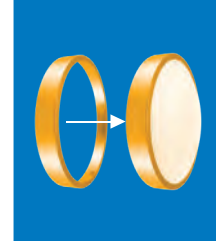
	Mã số / Diễn giải	Đơn giá (VNĐ)
	<b>BD30-R</b> Màu đỏ (Red) 20W	<b>206.800</b>
	<b>BD35-R</b> Màu đỏ (Red) 30W	<b>244.900</b>
	<b>BD30-G</b> Màu vàng (Gold) 20W	<b>206.800</b>
	<b>BD35-G</b> Màu vàng (Gold) 30W	<b>244.900</b>



- Điều khiển qua ứng dụng Smart phone
- Đèn được đổi màu tự động hoặc điều khiển đổi màu qua app MPE Smart Control với hệ màu RGB
- Đèn có thể đổi màu sang màu đỏ, xanh lá, xanh dương hoặc bất kỳ màu đơn sắc nào

- Mạch siêu dẫn giúp hiệu suất phát sáng cao hơn, tiết kiệm năng lượng
- Cấu trúc bảo vệ cách nhiệt nhiều lớp an toàn hơn
- Lắp đặt dễ dàng, uốn lượn được mọi nơi cần trang trí

## LED Dây Thông Minh ZIGBEE - WIFI



Mã hàng Model	Nguồn ra VDC	Nhiệt độ màu CCT	Dòng điện Ampe	Công suất Watt	Chiều dài Meter	Đóng gói Package	Đơn giá (VNĐ)
LS/ZB	12VDC	RGB	5A	14.4W/m	5m	5 m/hộp 5 m/box 40 hộp/thùng 40 box/carton	<b>1.048.700</b>
LS/SC	12VDC	RGB	5A	14.4W/m	5m	5 m/hộp 5 m/box 40 hộp/thùng 40 box/carton	<b>1.048.700</b>
LSAC/SC	220VDC	RGB	2A	8W/m	25m	25 m/thùng 25 m/carton	<b>165.200/m</b>

## Bộ Nguồn LED Dây WIFI AC 220V



Mã hàng Model	Công suất Watt	Đơn giá (VNĐ)
CLS/SC	400W	<b>1.107.700</b>



Mã hàng Model	Đơn giá (VNĐ)
MC-LSAC/SC Khớp nối giữa LED Dây Thông Minh AC	<b>42.800</b>

# LED Pha Thông Minh Wifi



- Điều khiển qua ứng dụng Smart phone
- Điều khiển thông minh kết nối qua Amazon Alexa, Google Assistant
- Đèn được đổi màu tự động hoặc điều khiển đổi màu qua app MPE Smart Control với hệ màu RGB
- Đèn có thể đổi màu sang màu đỏ, xanh lá, xanh dương hoặc bất kỳ màu đơn sắc nào
- Cấp độ bảo vệ IP65
- Thân nhôm bền bỉ, thiết kế gọn nhẹ
- Tiết kiệm điện năng, tuổi thọ cao 30.000 giờ
- Dễ dàng lắp đặt và sử dụng



**DIALux**  
German Technology

## LED Pha Thông Minh WIFI



Mã hàng Model	Công suất Watt	Nhiệt độ màu CCT	Kích thước Size	Đóng gói Package	Đơn giá (VNĐ)
<b>FLD-50/SC</b>	50W	RGB-W	238x238x100 mm	1 cái/hộp 20 cái/thùng	<b>1.179.200</b>
<b>FLD-100/SC</b>	100W	RGB	290x278x120 mm	1 cái/hộp 20 cái/thùng	<b>2.079.000</b>
<b>FLD-150/SC</b>	150W	RGB	335x323x136 mm	1 cái/hộp 20 cái/thùng	<b>2.898.500</b>













## LED Nhà Xưởng Thông Minh WIFI



Mã hàng Model	Quang thông Lumens	Nhiệt độ màu CCT	Kích thước Size	Đóng gói Package	Đơn giá (VNĐ)
<b>HB-100T/SC</b>	12.000Lm	6500k Dimmable	280x220mm	1 cái/thùng	<b>6.634.300</b>
<b>HB-150T/SC</b>	18.000Lm	6500k Dimmable	340x220mm	1 cái/thùng	<b>8.448.900</b>
<b>HB-200T/SC</b>	24.000Lm	6500k Dimmable	400x220mm	1 cái/thùng	<b>9.810.600</b>



## Cảm biến - đo lường - thiết bị bảo vệ - WIFI

	Mã số / Diễn giải	Đơn giá(VNĐ)		Mã số / Diễn giải	Đơn giá(VNĐ)
	<b>DS1/SC</b> Cảm biến cửa - Phát hiện tình trạng đóng/mở cửa	<b>743.600</b>		<b>GAS1/SC</b> Cảm biến Gas Phát hiện rò rỉ khí Gas và cảnh báo	<b>1.210.000</b>
	<b>MS1/SC</b> Cảm biến chuyển động - Phát hiện chuyển động trong phạm vi 7m	<b>925.100</b>		<b>LMS1/SC</b> Cảm biến quang - Đo độ sáng trong phạm vi 5m, hiển thị trên ứng dụng	<b>771.500</b>
	<b>WS1/SC</b> Cảm biến nước - Có âm thanh và cảnh báo khi có phát hiện rò rỉ nước	<b>825.000</b>		<b>SR1/SC</b> Còi báo động - Âm thanh 85dB - Có nhiều âm thanh để lựa chọn	<b>1.361.800</b>
	<b>SMS1/SC</b> Cảm biến khói - Phát hiện khói và cảnh báo cháy - Có âm thanh và nhấp đèn (85dB)	<b>1.108.800</b>		<b>THD1/SC</b> Máy dò chất lượng không khí - Đo nhiệt độ - Đo độ ẩm - Đo hạt bụi trong không khí	<b>3.656.700</b>
	<b>COS1/SC</b> Cảm biến khí CO - Có âm thanh và nhấp đèn (85dB)	<b>3.127.700</b>		<b>EVD1/SC</b> Máy dò chất lượng không khí đa năng - Đo nhiệt độ - Đo độ ẩm - Đo hạt bụi trong không khí - Đo các thông số CH20, VOC, CO2	<b>9.811.800</b>
	Mã số / Diễn giải	Đơn giá(VNĐ)		Mã số / Diễn giải	Đơn giá(VNĐ)
	<b>TMS1/SC</b> Thiết bị đo nhiệt độ có tích hợp bộ điều khiển - Hiển thị thời gian - Độ nhiệt độ môi trường - Điều khiển trực tiếp quạt (3 tốc độ), van nóng lạnh	<b>3.127.700</b>		<b>ARP1/SC</b> Máy lọc không khí - Lọc sạch bụi bẩn trong không khí - 8 tốc độ quạt cho phép làm sạch nhanh hơn - Đo số lượng hạt bụi trong không khí với kích thước hạt 2.5µm - 3 chế độ - Có tính năng an toàn cho trẻ em - Dễ dàng vệ sinh và thay thế linh kiện	<b>13.854.300</b>

## Khóa cửa, rèm cửa smart WIFI - Zigbee



Vân tay



Chìa khóa





Smart Control





Thẻ từ





Password

	Mã số / Diễn giải	Đơn giá (VNĐ)
	<b>DL1-D/SC</b> Khóa cửa Smart Wifi - Khóa màu đen - 5 cách mở khóa cửa	<b>9.400.600</b>
	<b>DL2-V/SC</b> Khóa cửa Smart Wifi - Khóa màu vàng - 5 cách mở khóa cửa	<b>14.814.000</b>



	Mã số / Diễn giải	Đơn giá (VNĐ)
	<b>DL2-D/SC</b> Khóa cửa Smart Wifi - Khóa màu đen - 5 cách mở khóa cửa	<b>14.814.000</b>

Rèm Cửa Thông Minh Wifi	Mã số / Diễn giải	Đơn giá (VNĐ)
	<b>CM1/SC</b> Curtain - Điện áp: 220VAC - Công suất: 6.5W, IP20 - Tốc độ: 16cm/s	<b>4.170.800</b>
	<b>CR1/SC</b> Thanh ray rèm cửa - Chiều dài: 1m	<b>1.043.000</b>

Rèm Cửa Thông Minh Wifi	Mã số / Diễn giải	Đơn giá (VNĐ)
	<b>RMC/SC</b> Remote điều khiển rèm cửa - Mỗi remote điều khiển được 2 motor - Khoảng cách: 10m	<b>531.300</b>
	<b>RB1/SC</b> Màn chiếu Smart	<b>2.286.900</b>

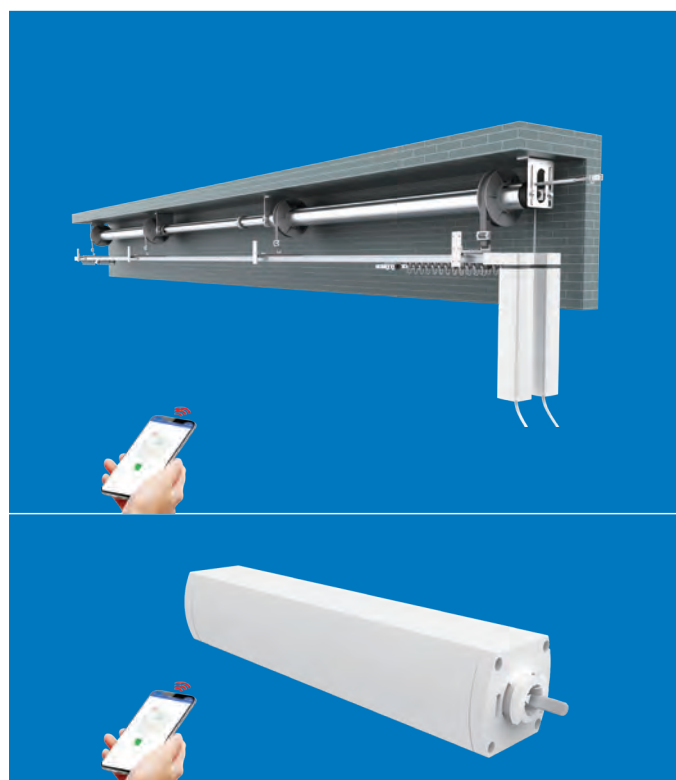
### Rèm Cửa Thông Minh Wifi - Zigbee



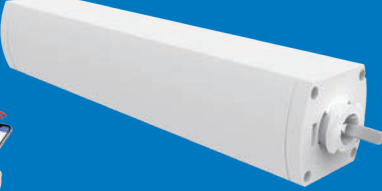







	Mã số / Diễn giải	Đơn giá (VNĐ)
	<b>CM2.2/SC</b> Bộ rèm cửa 2.2m - Wifi	<b>5.769.000</b>
	<b>CM3.2/SC</b> Bộ rèm cửa 3.2m - Wifi	<b>6.656.100</b>
	<b>CM4.2/SC</b> Bộ rèm cửa 4.2m - Wifi	<b>7.542.700</b>
	<b>CM1/ZB</b> Motor rèm cửa Zigbee - IP20 - Điện áp : 240VAC - Công suất : 40W - Khối lượng tải : 50 kg - Phạm vi điều khiển bằng Remote 50m	<b>4.170.800</b>

## Camera, Chuông cửa, đui đèn, ổ cắm đa năng, van khóa - WIFI

Camera Thông Minh Wifi	Mã số / Diễn giải	Đơn giá(VNĐ)	Camera Thông Minh Wifi	Mã số / Diễn giải	Đơn giá(VNĐ)
	<b>CI1/SC</b> Camera trong nhà Indoor camera - Góc xoay: 355° - Góc ảnh: 80° - Định dạng video H264 - Ống kính: 3.6mm - Độ phân giải 2MP - Hỗ trợ thẻ nhớ 128GB	<b>1.952.000</b>		<b>C01/SC</b> Camera ngoài trời Outdoor Camera - Ống kính: 3.6mm - Góc ảnh: 80° - Định dạng H264 - Độ phân giải 2MP - Hồng ngoại: 8-10m - Kết nối APP smart - Độ phân giải 2MP - Hỗ trợ thẻ nhớ 128GB	<b>2.102.100</b>
	<b>VDB1/SC</b> Chuông cửa Camera Smart Doorbell with camera - Đàm thoại 2 chiều - Tự động ghi hình khi phát hiện chuyển động	<b>3.400.300</b>		<b>SDB1/SC</b> Chuông cửa Smart Doorbell - Có 5 âm thanh để lựa chọn - Khoảng cách: <50m - Âm lượng: 0-90 dB - Chỉ sử dụng với VDB1/SC	<b>619.100</b>
	<b>LA01/SC</b> - Đui đèn chuyển bóng đèn thường thành bóng Smart - Đui E27	<b>566.000</b>		<b>SB01/SC</b> Hộp điều khiển từ xa thông minh	<b>408.900</b>
	<b>RC-433/SC</b> Điều khiển thông minh - Tối đa 4 thiết bị - Khoảng cách điều khiển: 30m	<b>136.300</b>			
	<b>WV1/SC</b> Ổ cắm đa năng chống thấm nước	<b>2.150.600</b>		<b>SWP1/SC</b> Van khóa nước/ gas - Lực mở: 1.6 MPA - Mô men xoắn: 30-60 kg.cm3	<b>1.247.400</b>

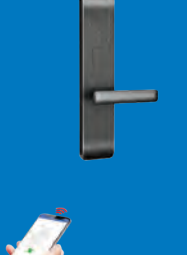
## Cảm biến - đo lường - thiết bị bảo vệ Zigbee, Gateway

	Mã số / Diễn giải	Đơn giá (VNĐ)		Mã số / Diễn giải	Đơn giá (VNĐ)
	<b>DS1/ZB</b> Cảm biến cửa - Phát hiện tình trạng đóng/mở cửa	743.600		<b>SMS1/ZB</b> Cảm biến khói - Phát hiện khói và cảnh báo cháy - Có âm thanh và nháy đèn (85dB)	1.108.800
	<b>MS1/ZB</b> Cảm biến chuyển động - Phát hiện chuyển động trong phạm vi 7m	925.100		<b>GAS1/ZB</b> Cảm biến Gas Phát hiện rò rỉ khí Gas và cảnh báo	1.210.000
	<b>WS1/ZB</b> Cảm biến nước - Có âm thanh và cảnh báo khi có phát hiện rò rỉ nước	825.000		<b>SR1/ZB</b> Còi báo động - Âm thanh 85dB - Có nhiều âm thanh để lựa chọn	1.361.800
	<b>OCS/ZB</b> Cảm biến chuyển động và ánh sáng - Phát hiện chuyển động trong phạm vi 10m	2.610.700		<b>DL2-D/ZB</b> Khóa cửa Smart Zigbee - Khóa màu đen - 5 cách mở khóa cửa	14.814.000
	<b>PRS/ZB</b> Cảm biến hiện diện - Phát hiện chuyển động trong phạm vi 3-4m	5.201.800			

### Gateway Wifi -> Bluetooth

	Mã hàng Model	Đơn giá (VNĐ)
	<b>GT02-W/BT</b> Gateway chuyển từ Wifi sang Bluetooth	773.900

### Gateway Wifi -> Zigbee

	Mã hàng Model	Đơn giá (VNĐ)
	<b>GT02-W/ZB</b> Gateway chuyển từ Wifi sang Zigbee	1.848.000

### Gateway Wifi -> IR

	Mã hàng Model	Đơn giá (VNĐ)
	<b>GT02-W/IR</b> Gateway chuyển từ Wifi sang IR	831.600

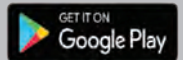

**New**



- » Chuông cửa camera
- » Cảm biến chuyển động
- » Cảm biến cửa và remote

**New**



- » Chuông smart
- » Cảm biến cửa/chuyển động
- » Remote

Mã số / Diễn giải	Đơn giá (VNĐ)
<p><b>HASK/W</b></p> <ul style="list-style-type: none"> <li>- Điện áp đầu vào: 5VDC</li> <li>- Giọng nói: Alexa, Google home</li> <li>- Âm lượng: 80-120dB</li> <li>- Mức âm lượng: 8</li> <li>- Nhiệt độ làm việc: -20~55°C</li> <li>- Độ ẩm làm việc: 20-95%</li> <li>- Điều khiển bằng app MPE Smart Control</li> </ul>	<p><b>7.927.300</b></p>

Mã số / Diễn giải	Đơn giá (VNĐ)
<p><b>MFDB/W</b></p> <ul style="list-style-type: none"> <li>- Điện áp đầu vào: 100-240VAC/50Hz</li> <li>- Nhiệt độ làm việc: -20~55°C</li> <li>- Độ ẩm làm việc: 20-95%</li> <li>- Điều khiển bằng app MPE Smart Control</li> </ul>	<p><b>3.963.700</b></p>

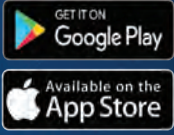

**New**



**ĐẶC ĐIỂM KỸ THUẬT:**

- Sản phẩm có mạch tích hợp và độ nhạy cao
- Cảm biến chuyển động hồng ngoại
- Cảm biến sáng tối tự động
- Tiện lợi, an toàn và tiết kiệm năng lượng
- Thiết kế hiện đại, dễ dàng cài đặt và sử dụng
- Điều khiển bằng App MPE Smart Control

	Mã số / Diễn giải	Đơn giá (VNĐ)
	<b>MIR1-NT/DW</b> Cảm biến chuyển động hồng ngoại WIFI - Công suất tiêu thụ: 0.5W - Công suất tải: <200W - Góc quét: 90° - Bán kính làm việc: ≤ 4m (<24°C) - Điện áp: 220-240VAC - Chiều cao lắp đặt: 2.2-4m - IP20	<b>865.600</b>

	Mã số / Diễn giải	Đơn giá (VNĐ)
	<b>MIR1-OD/W</b> Cảm biến chuyển động hồng ngoại WIFI - Công suất tiêu thụ: 0.5W - Công suất tải: <200W - Góc quét: 180° - Khoảng cách hoạt động: ≤ 12m (<24°C) - Điện áp: 220-240VAC - Chiều cao lắp đặt: 1.8-2.5m - IP44	<b>883.000</b>

	<b>MIR1-NT/EW</b> Cảm biến chuyển động hồng ngoại WIFI - Công suất tiêu thụ: 0.5W - Công suất tải: <200W - Góc quét: 90° - Bán kính làm việc: ≤ 4m (<24°C) - Điện áp: 220-240VAC - Chiều cao lắp đặt: 2.2-4m - IP20	<b>967.000</b>
--	---	----------------

	<b>MIR2-AT/W</b> Cảm biến chuyển động hồng ngoại WIFI - Công suất tiêu thụ: 0.5W - Công suất tải: <200W - Góc quét: 90° - Khoảng cách hoạt động: ≤ 4m (<24°C) - Điện áp: 220-240VAC - Chiều cao lắp đặt: 2.2-4m - IP20	<b>866.600</b>
--	--	----------------

## Thiết bị cảm biến chuyển động Microwave, hồng ngoại, photocell

	<b>Mã số / Diễn giải</b>	<b>Đơn giá (VNĐ)</b>		<b>Mã số / Diễn giải</b>	<b>Đơn giá (VNĐ)</b>
	<p><b>MWS1-NT</b> Cảm biến chuyển động Microwave gắn nổi Công suất tải: ≤ 200W Góc quét: 360° Khoảng cách hoạt động: ≤ 8m (bán kính) IP20</p>	<b>371.800</b>		<p><b>IRHD1</b> Đui đèn cảm biến chuyển động hồng ngoại E27 Công suất tải: ≤ 60W Góc quét: 360° Khoảng cách hoạt động: ≤ 6m (bán kính) Điện áp: 110-240VAC Có thể điều chỉnh thời gian, độ nhạy sáng IP20</p>	<b>235.400</b>
	<p><b>MWS1-AT</b> Cảm biến chuyển động Microwave gắn âm Công suất tải: ≤ 200W Góc quét: 360° Khoảng cách hoạt động: ≤ 8m (bán kính) IP20</p>	<b>407.000</b>		<p><b>IRHD2</b> Đui đèn cảm biến chuyển động hồng ngoại E27 Công suất tải: ≤ 60W Góc quét: 120° Khoảng cách hoạt động: ≤ 6m (bán kính) IP20</p>	<b>249.700</b>
	<p><b>MWS2-NT</b> Cảm biến chuyển động Microwave gắn nổi Công suất tải: ≤ 200W Góc quét: 360° Khoảng cách hoạt động: ≤ 8m (bán kính) IP20</p>	<b>371.800</b>		<p><b>IRS1-V</b> Cảm biến chuyển động Hồng ngoại vuông Công suất tải: ≤ 200W Góc quét: 160° Khoảng cách hoạt động: ≤ 9m (bán kính) IP20</p>	<b>269.500</b>
	<p><b>MWHD1</b> Đui đèn cảm biến Microwave Công suất tải: ≤ 60W Góc quét: 360° Khoảng cách hoạt động: ≤ 5m (bán kính) IP20</p>	<b>455.400</b>		<p><b>IRS2-V</b> Cảm biến chuyển động Hồng ngoại vuông (mặt kính) Công suất tải: ≤ 200W Góc quét: 160° Khoảng cách hoạt động: ≤ 9m (bán kính) IP20</p>	<b>407.000</b>
	<p><b>PTC1</b> Cảm biến quang Photocell Công suất tải: ≤ 10A Hoạt động khi ánh sáng: &lt; 5-15 Lux IP44</p>	<b>227.700</b>		<p><b>IRS1-H</b> Cảm biến chuyển động Hồng ngoại chữ nhật Công suất tải: ≤ 200W Góc quét: 180° Khoảng cách hoạt động: ≤ 9m (bán kính) IP20</p>	<b>255.200</b>





# HỆ THỐNG ĐIỀU KHIỂN MPE SMART LIGHTING



# LED Bulb Bluetooth



## LED Bulb Điều Khiển Bluetooth

	Mã hàng Model	Quang thông Lumens	Nhiệt độ màu CCT	Điều khiển Control	Kích thước Size	Đóng gói Package	Đơn giá (VNĐ)
	LB-9/SM	850 lm	2700 - 6500K RGB	App, Bluetooth remote control	Ø60x118 mm	1 cái/hộp 10 cái/thùng	<b>481.700</b>
	LB-13/SM	1200 lm	2700 - 6500K RGB	App, Bluetooth remote control	Ø95x135 mm	1 cái/hộp 10 cái/thùng	<b>594.900</b>

## LED Bulb Dây Tóc Điều Khiển Bluetooth

	Mã hàng Model	Quang thông Lumens	Nhiệt độ màu CCT	Điều khiển Control	Kích thước Size	Đóng gói Package	Đơn giá (VNĐ)
	FLM6/SM	600 lm	2700K	App, Bluetooth remote control	Ø60x110 mm	1 cái/hộp 10 cái/thùng	<b>398.500</b>

## Thiết Bị Điều Khiển / Remote

	Mã hàng Model	Đơn giá (VNĐ)
	RCS	<b>306.100</b>

	Mã hàng Model	Đơn giá (VNĐ)
	RCL	<b>306.100</b>



## Gateway



	Mã hàng Model	Đơn giá (VNĐ)
	GT01-W/BL	<b>773.900</b>



# LED Panel Bluetooth







LED Panel Tròn Âm Smart Bluetooth	Mã hàng Model	Quang thông Lumens	Điều khiển Control	Kích thước Size	Đục lỗ Cut out	Đóng gói Package	Đơn giá (VNĐ)
	RPL-6/SM	420 lm	App, Bluetooth remote control	Ø120x25 mm	Ø105 mm	1 cái/hộp 10 cái/thùng	<b>831.600</b>
	RPL-12/SM	800 lm	App, Bluetooth remote control	Ø170x25 mm	Ø155 mm	1 cái/hộp 10 cái/thùng	<b>980.700</b>
	RPL-18/SM	1100 lm	App, Bluetooth remote control	Ø225x25 mm	Ø210 mm	1 cái/hộp 10 cái/thùng	<b>1.152.700</b>

LED Panel Tròn Nổi Smart Bluetooth	Mã hàng Model	Quang thông Lumens	Điều khiển Control	Kích thước Size	Nhiệt độ màu	Đóng gói Package	Đơn giá (VNĐ)
	SRPL-18/SM	1100 lm	App, Bluetooth remote control	Ø225x38 mm	2700-6500K RGB	1 cái/hộp 10 cái/thùng	<b>1.244.000</b>
	SRPL-24/SM	1500 lm	App, Bluetooth remote control	Ø300x38 mm	2700-6500K RGB	1 cái/hộp 10 cái/thùng	<b>1.615.900</b>

# LED Ốp Trần Bluetooth



LED Ốp Trần Ceiling Bluetooth	Mã hàng Model	Công suất Watt	Quang thông Lumens	Nhiệt độ màu CCT	Kích thước Size	Đóng gói Package	Đơn giá (VNĐ)
 	<b>CL20/SM</b>	20W	2000 Lm	2700-6500K RGB	Ø300x85 mm	1 cái/hộp 5 cái/thùng	<b>1.153.900</b>
 	<b>CL30/SM</b>	30W	3000 Lm	2700-6500K RGB	Ø350x85 mm	1 cái/hộp 5 cái/thùng	<b>1.542.000</b>

Viên Đèn	Mã hàng Model	Đơn giá (VNĐ)
	<b>BD30-W</b> Màu trắng (White) 20W	<b>206.800</b>
	<b>BD35-W</b> Màu trắng (White) 30W	<b>244.900</b>
	<b>BD30-S</b> Màu xám bạc (Silver) 20W	<b>206.800</b>
	<b>BD35-S</b> Màu xám bạc (Silver) 30W	<b>244.900</b>
	<b>BD30-C</b> Màu crôm (Chromi) 20W	<b>206.800</b>
	<b>BD35-C</b> Màu crôm (Chromi) 30W	<b>244.900</b>

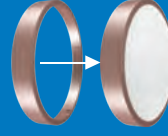
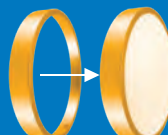
Viên Đèn	Mã hàng Model	Đơn giá (VNĐ)
	<b>BD30-R</b> Màu đỏ (Red) 20W	<b>206.800</b>
	<b>BD35-R</b> Màu đỏ (Red) 30W	<b>244.900</b>
	<b>BD30-G</b> Màu vàng (Gold) 20W	<b>206.800</b>
	<b>BD35-G</b> Màu vàng (Gold) 30W	<b>244.900</b>

# LED Panel Tắm Bluetooth



LED Panel Tắm Bluetooth	Mã hàng Model	Hệ số công suất	Quang thông Lumens	Nhiệt độ màu CCT	Điều khiển Control	Kích thước Size	Đóng gói Package	Đơn giá (VNĐ)
	FPL-3030/SM	>0.9	1700 Lm	2700-6500K RGB	App Bluetooth, remote control	296x296 mm	1 cái/hộp 4 cái/thùng	2.142.600
	FPL-6060/SM	>0.9	3000 Lm	2700-6500K RGB	App Bluetooth, remote control	596x596 mm	1 cái/hộp 4 cái/thùng	3.411.900
	FPL-12030/SM	>0.9	3000 Lm	2700-6500K RGB	App Bluetooth, remote control	1196x296 mm	1 cái/hộp 3 cái/thùng	4.233.100

## Phụ kiện Gắn Treo Panel LED Tắm

Mã hàng Model	Đơn giá (VNĐ)
PKL-60	100.900
PKL-120	201.000

## Phụ Kiện Gắn Nổi Panel LED Tắm

Mã hàng Model	Đơn giá (VNĐ)
SMPL-3030	302.600
SMPL-6030	375.400
SMPL-6060	485.100
SMPL-12030	519.800

## Đèn ngủ thông minh Bluetooth

Mã hàng Model	Đơn giá (VNĐ)
BHS1 Đèn ngủ thông minh - 1W-9W - Nhiệt độ màu 2700k-6500k-RGB	2.246.500

## LED Dây Bluetooth

Mã hàng Model	Đơn giá (VNĐ)
LS/SM Đèn LED dây Smart - 10W/ 5m - Nhiệt độ màu: RGB	1.048.700

## Đèn Bàn LED 3 Chế Độ

Mã hàng Model	Đơn giá (VNĐ)
TL1S Đèn LED bàn 3 chế độ sáng - 2.2W/5V-500mA - Nhiệt độ màu 3000-4000-6000k	852.400
TL1G Đèn LED bàn 3 chế độ sáng - 2.2W/5V-500mA - Nhiệt độ màu 3000-4000-6000k	852.400

## Đèn Bàn LED 3 Chế Độ

Mã hàng Model	Đơn giá (VNĐ)
TL2 Đèn bàn cảm ứng 6W nhiệt độ màu 3000-4000-6000k màu trắng	651.400
TL3 Đèn bàn cảm ứng 4W nhiệt độ màu 3000-4000-6500k màu trắng xanh, trắng hồng	449.400



Seri RPL/3C-RC	Mã hàng Model	Quang thông Lumens	Nhiệt độ màu CCT	Kích thước Size	Đục lỗ Cut out	Đóng gói Package	Đơn giá (VNĐ)
 <p>3 màu</p> <p>6W</p>	RPL-6/3C-RC	500 Lm	6000 - 6500k 4000 - 4500k 2800 - 3200k	Ø120x25 mm	Ø105 mm	1 cái/hộp 60 cái/thùng	<b>490.900</b>
 <p>3 màu</p> <p>6W</p>	RPL-6S/3C-RC	500 Lm	6000 - 6500k 4000 - 4500k 2800 - 3200k	Ø110x25 mm	Ø 90 mm	1 cái/hộp 60 cái/thùng	<b>490.900</b>
 <p>3 màu</p> <p>9W</p>	RPL9/3C-RC	750 Lm	6000 - 6500k 4000 - 4500k 2800 - 3200k	Ø150x25 mm	Ø130 mm	1 cái/hộp 40 cái/thùng	<b>545.200</b>
 <p>3 màu</p> <p>12W</p>	RPL12/3C-RC	950 Lm	6000 - 6500k 4000 - 4500k 2800 - 3200k	Ø170x25 mm	Ø150 mm	1 cái/hộp 40 cái/thùng	<b>592.600</b>
 <p>3 màu</p> <p>15W</p>	RPL15/3C-RC	1300 Lm	6000 - 6500k 4000 - 4500k 2800 - 3200k	Ø190x25 mm	Ø180 mm	1 cái/hộp 30 cái/thùng	<b>681.500</b>
 <p>3 màu</p> <p>18W</p>	RPL18/3C-RC	1500 Lm	6000 - 6500k 4000 - 4500k 2800 - 3200k	Ø225x25 mm	Ø205 mm	1 cái/hộp 20 cái/thùng	<b>727.700</b>
 <p>3 màu</p> <p>24W</p>	RPL24/3C-RC	1800 Lm	6000 - 6500k 4000 - 4500k 2800 - 3200k	Ø300x25 mm	Ø280 mm	1 cái/hộp 10 cái/thùng	<b>981.800</b>

## LED Tấm Điều chỉnh Độ Sáng Bằng Remote



Seri FPL/3C-RC	Mã hàng Model	Quang thông Lumens	Nhiệt độ màu CCT	Kích thước Size	Đóng gói Package	Đơn giá (VNĐ)
	FPL-3030/3C-RC	1800 lm	6000 - 6500k 4000 - 4500k 2800 - 3200k	300x300x10 mm	1 cái/hộp 10 cái/thùng	<b>1.247.400</b>
	FPL-6030/3C-RC	2250 lm	6000 - 6500k 4000 - 4500k 2800 - 3200k	600x300x10 mm	1 cái/hộp 5 cái/thùng	<b>1.614.700</b>
	FPL-6060/3C-RC	3600 lm	6000 - 6500k 4000 - 4500k 2800 - 3200k	600x600x10 mm	1 cái/hộp 5 cái/thùng	<b>2.088.200</b>
	FPL-12030/3C-RC	3600 lm	6000 - 6500k 4000 - 4500k 2800 - 3200k	1200x300x10 mm	1 cái/hộp 5 cái/thùng	<b>2.143.700</b>

### Phụ Kiện Gắn Treo Cho Seri FPL

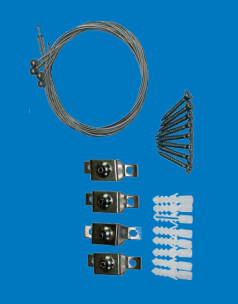
Mã hàng Model	Đơn giá (VNĐ)
 PKL - 60	<b>100.900</b>
PKL - 120	<b>201.000</b>

### Phụ Kiện Gắn Nổi Cho Seri FPL

Mã hàng Model	Đơn giá (VNĐ)
 SMPL-3030	<b>302.600</b>
SMPL-6030	<b>375.400</b>
SMPL-6060	<b>485.100</b>
SMPL-12030	<b>519.800</b>

## LED Tube Nhôm T8 Điều chỉnh Độ Sáng Bằng Remote

Mã hàng Model	Quang thông Lumens	Nhiệt độ màu CCT	Góc chiếu Angle	Kích thước Size	Đóng gói Package	Đơn giá (VNĐ)
 LT8-60/3C-RC	950 lm	6000 - 6500k 4000 - 4500k 2800 - 3200k	160°	A - 588mm B - 603mm C - Ø26mm	1 cái/hộp 25 cái/thùng	<b>706.900</b>
 LT8-120/3C-RC	1850 lm	6000 - 6500k 4000 - 4500k 2800 - 3200k	160°	A - 1197mm B - 1213mm C - Ø26mm	1 cái/hộp 25 cái/thùng	<b>822.400</b>

### Thiết bị Điều khiển / Remote RF

Mã hàng Model	Đơn giá (VNĐ)
 RC-RF	<b>207.900</b>

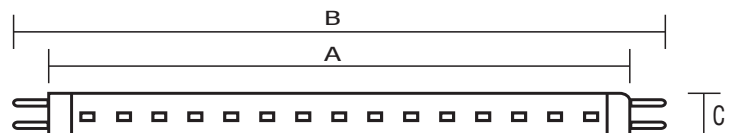

# MPE

## SOLAR

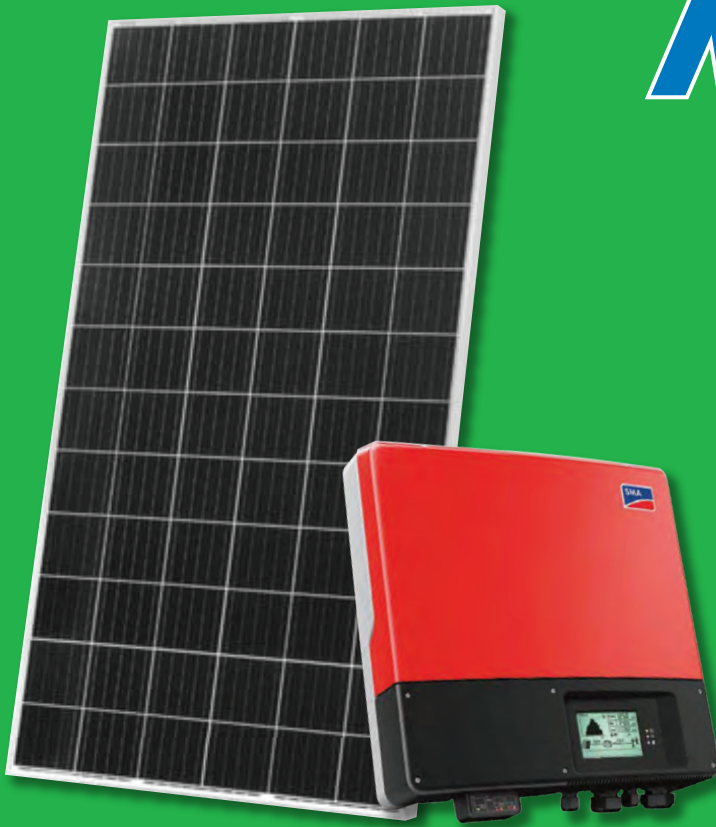

# MPE



## NHÀ MÁY MPE THÔNG MINH THEO TIÊU CHUẨN LEED

**NĂNG LƯỢNG  
MẶT TRỜI**

**SẢN XUẤT NĂNG LƯỢNG HIỆU QUẢ**

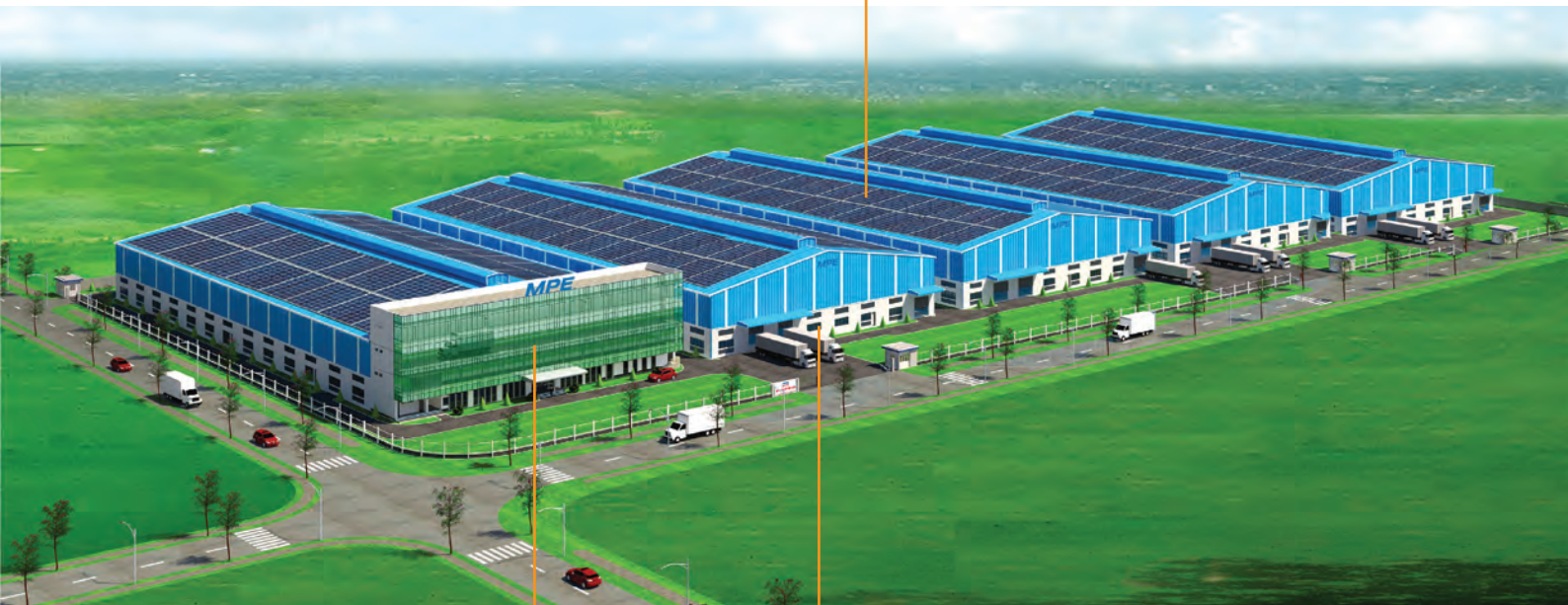

**THIẾT BỊ  
THÔNG MINH**

**QUẢN LÝ NĂNG LƯỢNG THÔNG MINH**

**ĐÈN LED  
THIẾT BỊ ĐIỆN**

**SỬ DỤNG NĂNG LƯỢNG TIẾT KIỆM**

**HỆ THỐNG SIÊU TIẾT KIỆM - DUY NHẤT TẠI MPE**



**DIALux**  
German Technology



# TẠI SAO PHẢI LẮP ĐẶT HỆ THỐNG MPE SOLAR ?

## 1. Điện tăng giá

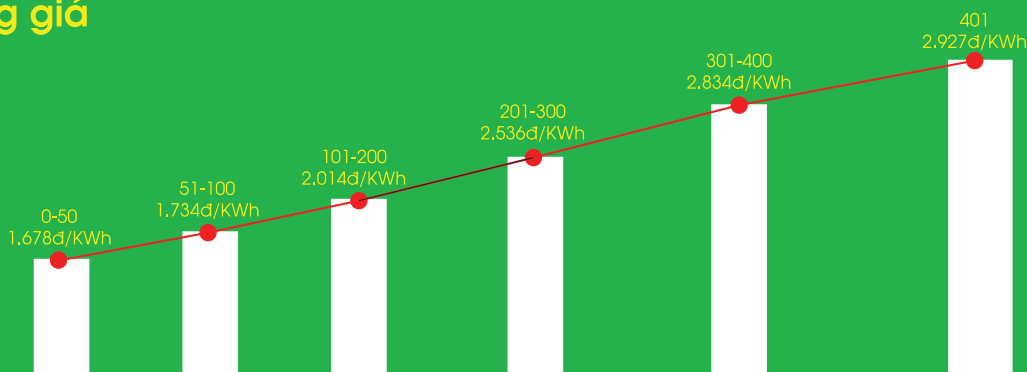

Khách hàng sử dụng 900 kWh/ tháng sẽ phải trả tiền điện theo giá 6 bậc thang tổng cộng là : 2.377.500 đ/tháng

## 2. MPE Solar sẽ giúp các bạn giảm ngay tiền điện

Nếu khách hàng đầu tư hệ thống MPE SOLAR 3.12 kWp thì:

- Sản lượng điện tạo ra trung bình hàng tháng:  
 $3.12\text{kWp} \times 4.5 \text{ giờ/ngày} \times 30 \text{ ngày} = 405 \text{ kWh}$  được công tơ 2 chiều của điện lực ghi nhận.
- Sản lượng điện tiêu thụ hàng tháng chỉ còn:  
 $900 \text{ kWh} - 405 \text{ kWh} = 495 \text{ kWh}$  (tương đương 1.188.015 đ)
- Vì vậy chi phí tiền điện hàng tháng giảm 50%



## 3. MPE Solar sử dụng công nghệ gì mà mang lại hiệu quả như vậy

- Hệ thống MPE SOLAR sử dụng công nghệ Đức.
- Sử dụng tấm Pin công nghệ mới với hiệu suất cao.
- Thiết kế gọn nhẹ, tiết kiệm diện tích lắp đặt.
- Bảo hành hệ thống : 10 năm (Pin, Inverter, giá đỡ, phụ kiện)
- Bảo hành hiệu suất trên 80% sau 25 năm
- Giá MPE SOLAR 3.12kWp : 75tr VNĐ ( bao gồm VAT )
- Giá MPE SOLAR 5.5kWp : 120tr VNĐ ( bao gồm VAT )

## 4. Sử dụng năng lượng tiết kiệm

- Các thiết bị chiếu sáng MPE với hiệu suất cao, tiết kiệm 50% điện năng tiêu thụ.
- Hệ thống phần mềm thiết kế chiếu sáng DIALux - MPE Plug in (Premium) - Germany giúp tiết kiệm điện cho công trình của bạn.
- Hệ thống MPE Smart Breaker, MPE Smart Control giúp chúng ta quản lý, giám sát và vận hành tất cả các thiết bị một cách tiết kiệm, an toàn, mọi lúc, mọi nơi.

## 5. MPE luôn đồng hành, hỗ trợ và mang lại giải pháp hữu ích cho bạn

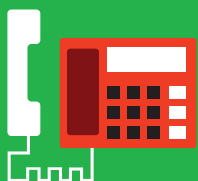

Tư vấn miễn phí

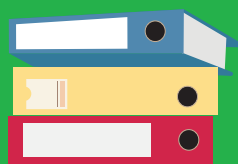

Hỗ trợ pháp lý, hướng dẫn từng bước khi giao dịch với các Cty Điện lực



Nhiều chương trình khuyến mãi hấp dẫn



Lắp đặt, bảo hành chuyên nghiệp

**MPE**

**MANG NĂNG LƯỢNG XANH VÀO CUỘC SỐNG**

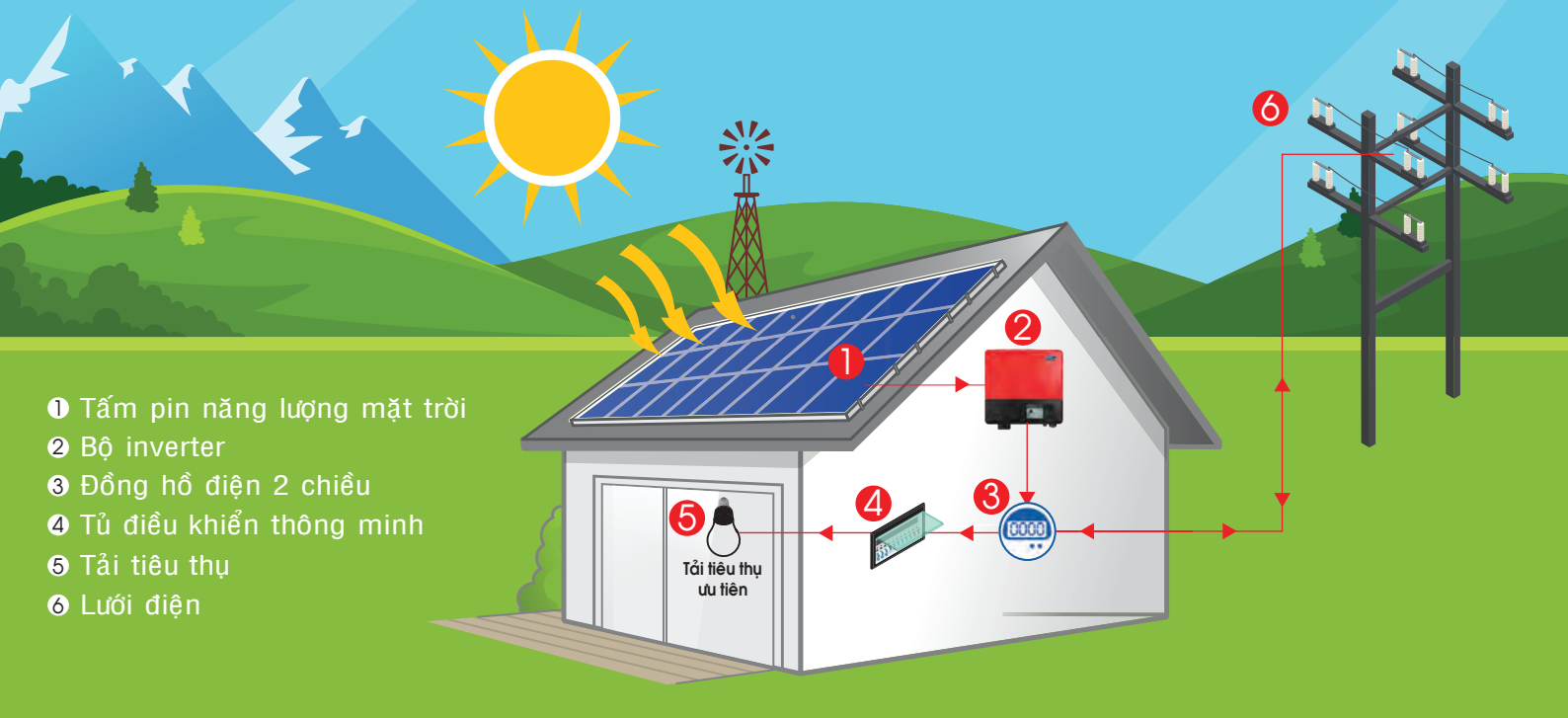

## NGUYÊN LÝ HOẠT ĐỘNG

### Khi không có ánh sáng mặt trời: (buổi tối hoặc trời mưa)

Các tấm Pin năng lượng mặt trời sẽ không sản sinh ra điện nên các phụ tải sẽ sử dụng điện từ lưới một cách bình thường

### Khi trời có nắng

Các tấm Pin sẽ hoạt động theo sơ đồ trên:

# 1

Tấm Pin năng lượng mặt trời hấp thụ quang năng từ mặt trời và tạo ra dòng điện một chiều (DC).

# 2

Dòng điện một chiều (DC) sẽ đi qua bộ chuyển đổi (Inverter) để biến đổi thành dòng điện xoay chiều (AC).

# 3

Công tơ điện 2 chiều: nếu công suất điện năng phát ra từ hệ thống điện mặt trời cung cấp cho thiết bị điện trong sinh hoạt sử dụng vẫn còn dư, thì phần dư sẽ đi qua công tơ điện hai chiều để ghi nhận lượng điện tải lên lưới điện quốc gia trong ngày, phần điện dư này được EVN mua lại.



# 4

Dòng điện xoay chiều (AC) đi qua tủ điện chứa các MCB và sẽ được truyền tải cung cấp cho các thiết bị điện sử dụng.

# 5

Lưới điện quốc gia: nếu hệ thống điện mặt trời không đủ công suất phát ra cho các thiết bị sử dụng điện, do ảnh hưởng của thời tiết hay lượng nắng ít, lúc này lưới điện quốc gia sẽ tự động bù điện để các thiết bị sử dụng không bị gián đoạn hoạt động.

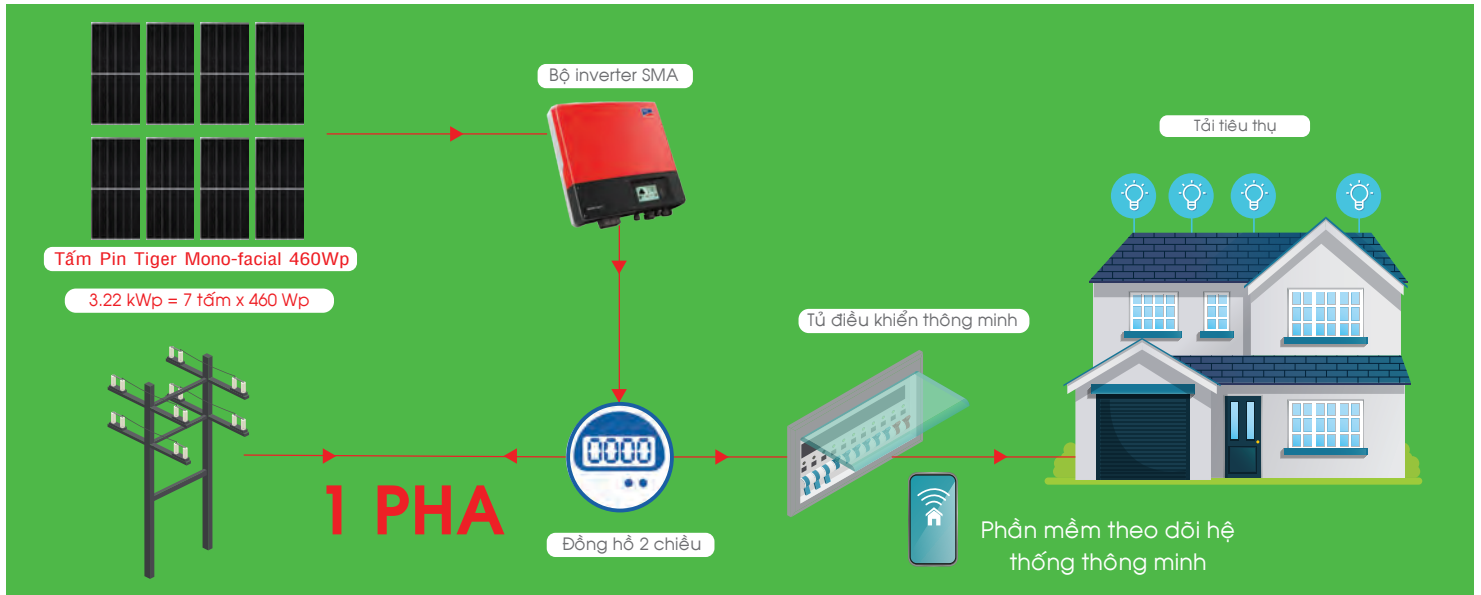

**GIÁ TRỌN GÓI (BH 5 năm): 78,1 TRIỆU VNĐ (Đã bao gồm VAT, chi phí vận chuyển và lắp đặt)**  
**GIÁ TRỌN GÓI (BH 10 năm): 83,6 TRIỆU VNĐ (Đã bao gồm VAT, chi phí vận chuyển và lắp đặt)**

Sản phẩm	Thông số chi tiết	Đơn vị tính	Số lượng	Bảo hành
<b>Tấm Pin Tiger Mono-facial 460Wp</b> 	<ul style="list-style-type: none"> <li>- Tấm pin JinKO</li> <li>- Model: Tiger Mono-facial (JKM460-7RL3-V)</li> <li>- Kích thước: 2182 x 1029 x 40mm</li> <li>- Trọng lượng: 26.1 kg</li> <li>- Mặt trước: Kính cường lực 3.2mm</li> <li>- Khung: Hợp kim Nhôm Anod</li> <li>- Hộp nối: IP67</li> <li>- Cáp DC: 1x 4.0mm<sup>2</sup></li> <li>- Công suất: <b>460Wp</b></li> <li>- Điện áp ở công suất cực đại: 43.08VDC</li> <li>- Dòng điện ở công suất cực đại: 10.68A</li> <li>- Điện áp hở mạch: 51.7VDC</li> <li>- Dòng điện ngắn mạch: 11.5A</li> <li>- Hiệu suất chuyển đổi quang năng: 20.49%</li> <li>- Nhiệt độ làm việc: âm 40°C đến 85°C</li> <li>- Dung sai công suất: 0~+3%</li> </ul>	Tấm	7	5 năm/10 năm
<b>Inverter</b> 	<ul style="list-style-type: none"> <li>- Inverter SMA</li> <li>- Model: SB-3000TL</li> <li>- Công suất đầu vào tối đa: 3200Wp</li> <li>- Điện áp DC đầu vào tối đa: 750V</li> <li>- Công suất đầu ra tối đa (230V/50Hz): 3000W</li> <li>- Điện áp AC: 230V</li> <li>- Dòng AC max: 16A</li> <li>- Hiệu suất chuyển đổi MAX/tiêu chuẩn EU: 97% / 96%</li> <li>- Kết nối PC, máy tính bảng, smart phone theo dõi số liệu kỹ thuật</li> </ul>	Bộ	1	5 năm/10 năm
<b>Khung, giá đỡ</b> 	<ul style="list-style-type: none"> <li>- Kẹp, thanh ray Schletter - Đức</li> </ul>	Bộ	1	5 năm/10 năm
<b>Dây cáp DC</b> 	<ul style="list-style-type: none"> <li>- Cáp DC tiêu chuẩn Châu Âu</li> </ul>	Bộ	1	5 năm/10 năm
<ul style="list-style-type: none"> <li>- Hệ thống đã bao gồm tủ điều khiển: Vô tủ, MCB, cầu chì, cáp AC</li> </ul>		Bộ	1	5 năm/10 năm

Trong một số trường hợp đặc biệt, công ty sẽ khảo sát và báo giá cụ thể theo thực tế  
 Quý khách sử dụng Pin 390Wp (JKM390M-72) sẽ giảm 5%

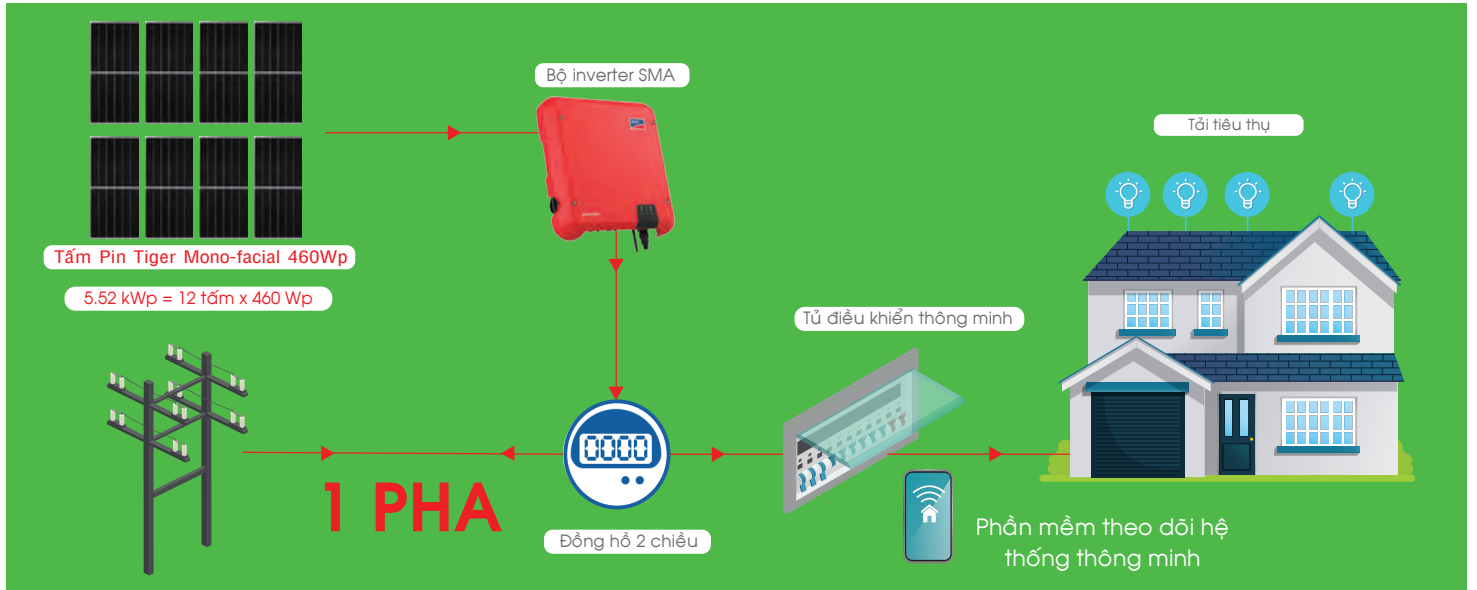

**GIÁ TRỌN GÓI (BH 5 năm): 127,6 TRIỆU VNĐ (Đã bao gồm VAT, chi phí vận chuyển và lắp đặt)**

**GIÁ TRỌN GÓI (BH 10 năm): 134,2 TRIỆU VNĐ (Đã bao gồm VAT, chi phí vận chuyển và lắp đặt)**

Sản phẩm	Thông số chi tiết	Đơn vị tính	Số lượng	Bảo hành
<b>Tấm Pin Tiger Mono-facial 460Wp</b> 	<ul style="list-style-type: none"> <li>- Tấm pin JinKO</li> <li>- Model: Tiger Mono-facial (JKM460-7RL3-V)</li> <li>- Kích thước: 2182 x 1029 x 40mm</li> <li>- Trọng lượng: 26.1 kg</li> <li>- Mặt trước: Kính cường lực 3.2mm</li> <li>- Khung: Hợp kim Nhôm Anod</li> <li>- Hộp nối: IP67</li> <li>- Cấp DC: 1x 4.0mm<sup>2</sup></li> <li>- Công suất: <b>460Wp</b></li> <li>- Điện áp ở công suất cực đại: 43.08VDC</li> <li>- Dòng điện ở công suất cực đại: 10.68A</li> <li>- Điện áp hở mạch: 51.7VDC</li> <li>- Dòng điện ngắn mạch: 11.5A</li> <li>- Hiệu suất chuyển đổi quang năng: 20.49%</li> <li>- Nhiệt độ làm việc: âm 40°C đến 85°C</li> <li>- Dung sai công suất: 0~+3%</li> </ul>	Tấm	12	5 năm/10 năm
<b>Inverter</b> 	<ul style="list-style-type: none"> <li>- Inverter SMA</li> <li>- Model: SB-5.0-1AV</li> <li>- Công suất đầu vào tối đa: 7500Wp</li> <li>- Điện áp DC đầu vào tối đa: 600V</li> <li>- Công suất đầu ra tối đa (230V/50Hz): 5000W</li> <li>- Điện áp AC: 230V</li> <li>- Dòng AC max: 22A</li> <li>- Hiệu suất chuyển đổi MAX/tiêu chuẩn EU: 97% / 96.5%</li> <li>- Kết nối PC, máy tính bảng, smart phone theo dõi số liệu kỹ thuật</li> </ul>	Bộ	1	5 năm/10 năm
<b>Khung, giá đỡ</b> 	<ul style="list-style-type: none"> <li>- Kẹp, thanh ray Schletter - Đức</li> </ul>	Bộ	1	5 năm/10 năm
<b>Dây cáp DC</b> 	<ul style="list-style-type: none"> <li>- Cáp DC tiêu chuẩn Châu Âu</li> </ul>	Bộ	1	5 năm/10 năm
- Hệ thống đã bao gồm tủ điều khiển: Vỏ tủ, MCB, cầu chì, cáp AC		Bộ	1	5 năm/10 năm

Trong một số trường hợp đặc biệt, công ty sẽ khảo sát và báo giá cụ thể theo thực tế

Quý khách sử dụng Pin 390Wp (JKM390M-72) sẽ giảm 5%

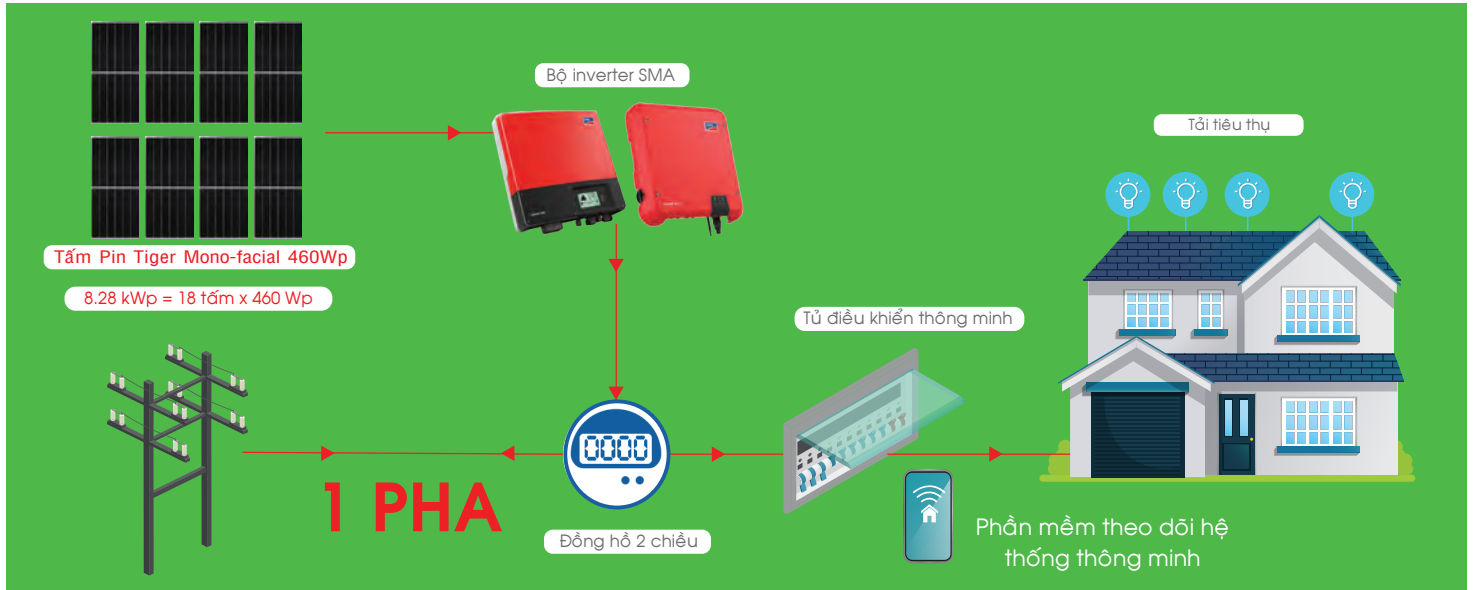

**GIÁ TRỌN GÓI (BH 5 năm): 195,8 TRIỆU VNĐ (Đã bao gồm VAT, chi phí vận chuyển và lắp đặt)**  
**GIÁ TRỌN GÓI (BH 10 năm): 206,8 TRIỆU VNĐ (Đã bao gồm VAT, chi phí vận chuyển và lắp đặt)**

Sản phẩm	Thông số chi tiết	Đơn vị tính	Số lượng	Bảo hành
<b>Tấm Pin Tiger Mono-facial 460Wp</b> 	<ul style="list-style-type: none"> <li>- Tấm pin Jinko</li> <li>- Model: Tiger Mono-facial (JKM460-7RL3-V)</li> <li>- Kích thước: 2182 x 1029 x 40mm</li> <li>- Trọng lượng: 26.1 kg</li> <li>- Mặt trước: Kính cường lực 3.2mm</li> <li>- Khung: Hợp kim Nhôm Anod</li> <li>- Hộp nối: IP67</li> <li>- Cáp DC: 1x 4.0mm2</li> <li>- Công suất: <b>460Wp</b></li> <li>- Điện áp ở công suất cực đại: 43.08VDC</li> <li>- Dòng điện ở công suất cực đại: 10.68A</li> <li>- Điện áp hở mạch: 51.7VDC</li> <li>- Dòng điện ngắn mạch: 11.5A</li> <li>- Hiệu suất chuyển đổi quang năng: 20.49%</li> <li>- Nhiệt độ làm việc: âm 40°C đến 85°C</li> <li>- Dung sai công suất: 0~+3%</li> </ul>	Tấm	18	5 năm/10 năm
<b>Inverter</b> 	<ul style="list-style-type: none"> <li>- Inverter SMA</li> <li>- Model: SB-3000TL + SB-5.0-1AV</li> <li>- Công suất đầu vào tối đa: 10700Wp</li> <li>- Điện áp DC đầu vào tối đa: 600V</li> <li>- Công suất đầu ra tối đa (230V/50Hz): 8000W</li> <li>- Điện áp AC: 230V</li> <li>- Dòng AC max: 48A</li> <li>- Hiệu suất chuyển đổi MAX/tiêu chuẩn EU: 97% / 96,5%</li> <li>- Kết nối PC, máy tính bảng, smart phone theo dõi số liệu kỹ thuật</li> </ul>	Bộ	1	5 năm/10 năm
<b>Khung, giá đỡ</b> 	<ul style="list-style-type: none"> <li>- Kẹp, thanh ray Schletter - Đức</li> </ul>	Bộ	1	5 năm/10 năm
<b>Dây cáp DC</b> 	<ul style="list-style-type: none"> <li>- Cáp DC tiêu chuẩn Châu Âu</li> </ul>	Bộ	1	5 năm/10 năm
<ul style="list-style-type: none"> <li>- Hệ thống đã bao gồm tủ điều khiển: Vỏ tủ, MCB, cầu chì, cáp AC</li> </ul>		Bộ	1	5 năm/10 năm

Trong một số trường hợp đặc biệt, công ty sẽ khảo sát và báo giá cụ thể theo thực tế  
 Quý khách sử dụng Pin 390Wp (JKM390M-72) sẽ giảm 5%

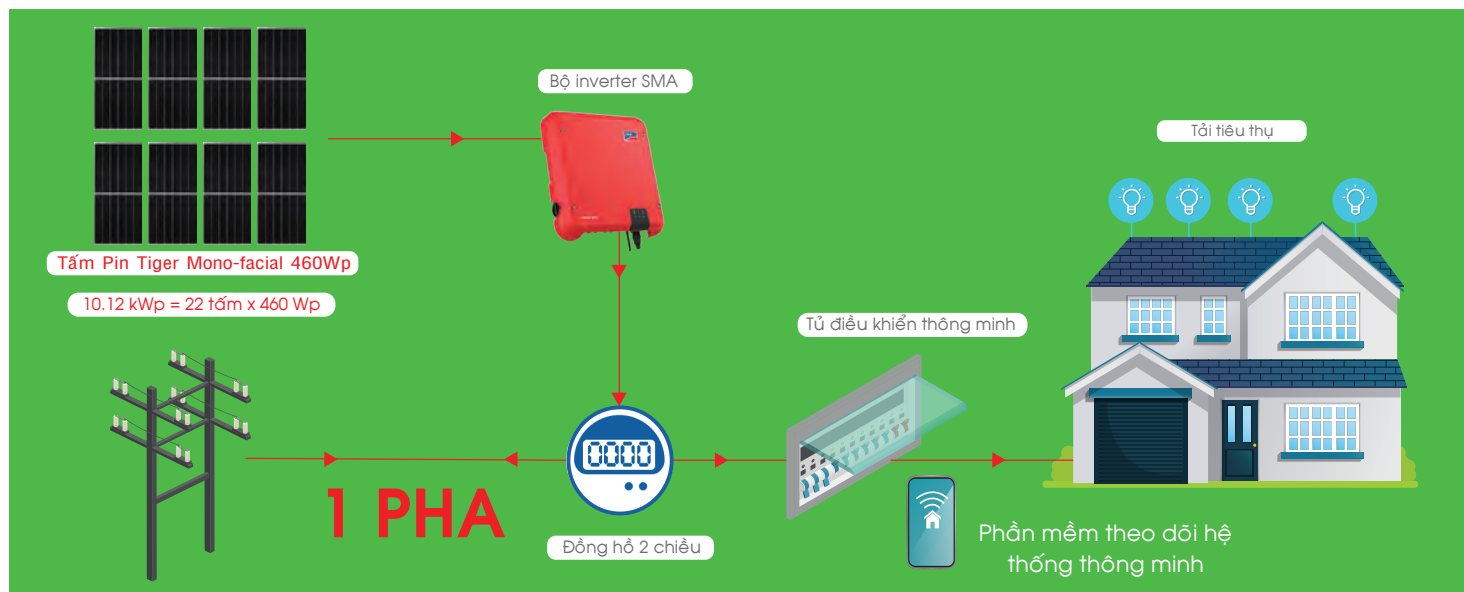

**GIÁ TRỌN GÓI (BH 5 năm): 228,8 TRIỆU VNĐ (Đã bao gồm VAT, chi phí vận chuyển và lắp đặt)**

**GIÁ TRỌN GÓI (BH 10 năm): 240,9 TRIỆU VNĐ (Đã bao gồm VAT, chi phí vận chuyển và lắp đặt)**

Sản phẩm	Thông số chi tiết	Đơn vị tính	Số lượng	Bảo hành
<b>Tấm Pin Tiger Mono-facial 460Wp</b> 	<ul style="list-style-type: none"> <li>- Tấm pin JinkO</li> <li>- Model: Tiger Mono-facial (JKM460-7RL3-V)</li> <li>- Kích thước: 2182 x 1029 x 40mm</li> <li>- Trọng lượng: 26.1 kg</li> <li>- Mặt trước: Kính cường lực 3.2mm</li> <li>- Khung: Hợp kim Nhôm Anod</li> <li>- Hộp nối: IP67</li> <li>- Cấp DC: 1x 4.0mm2</li> <li>- Công suất: <b>460Wp</b></li> <li>- Điện áp ở công suất cực đại: 43.08VDC</li> <li>- Dòng điện ở công suất cực đại: 10.68A</li> <li>- Điện áp hở mạch: 51.7VDC</li> <li>- Dòng điện ngắn mạch: 11.5A</li> <li>- Hiệu suất chuyển đổi quang năng: 20.49%</li> <li>- Nhiệt độ làm việc: âm 40°C đến 85°C</li> <li>- Dung sai công suất: 0~+3%</li> </ul>	Tấm	22	5 năm/10 năm
<b>Inverter</b> 	<ul style="list-style-type: none"> <li>- Inverter SMA</li> <li>- Model: SB-5.0-1AV</li> <li>- Công suất đầu vào tối đa: 15000Wp</li> <li>- Điện áp DC đầu vào tối đa: 600V</li> <li>- Công suất đầu ra tối đa (230V/50Hz): 10000W</li> <li>- Điện áp AC: 230V</li> <li>- Dòng AC max: 44A</li> <li>- Hiệu suất chuyển đổi MAX/tiêu chuẩn EU: 97% / 96%</li> <li>- Kết nối PC, máy tính bảng, smart phone theo dõi số liệu kỹ thuật</li> </ul>	Bộ	2	5 năm/10 năm
<b>Khung, giá đỡ</b> 	<ul style="list-style-type: none"> <li>- Kẹp, thanh ray Schletter - Đức</li> </ul>	Bộ	1	5 năm/10 năm
<b>Dây cáp DC</b> 	<ul style="list-style-type: none"> <li>- Cáp DC tiêu chuẩn Châu Âu</li> </ul>	Bộ	1	5 năm/10 năm
- Hệ thống đã bao gồm tủ điều khiển: Vỏ tủ, MCB, cầu chì, cáp AC		Bộ	1	5 năm/10 năm

Trong một số trường hợp đặc biệt, công ty sẽ khảo sát và báo giá cụ thể theo thực tế

Quý khách sử dụng Pin 390Wp (JKM390M-72) sẽ giảm 5%

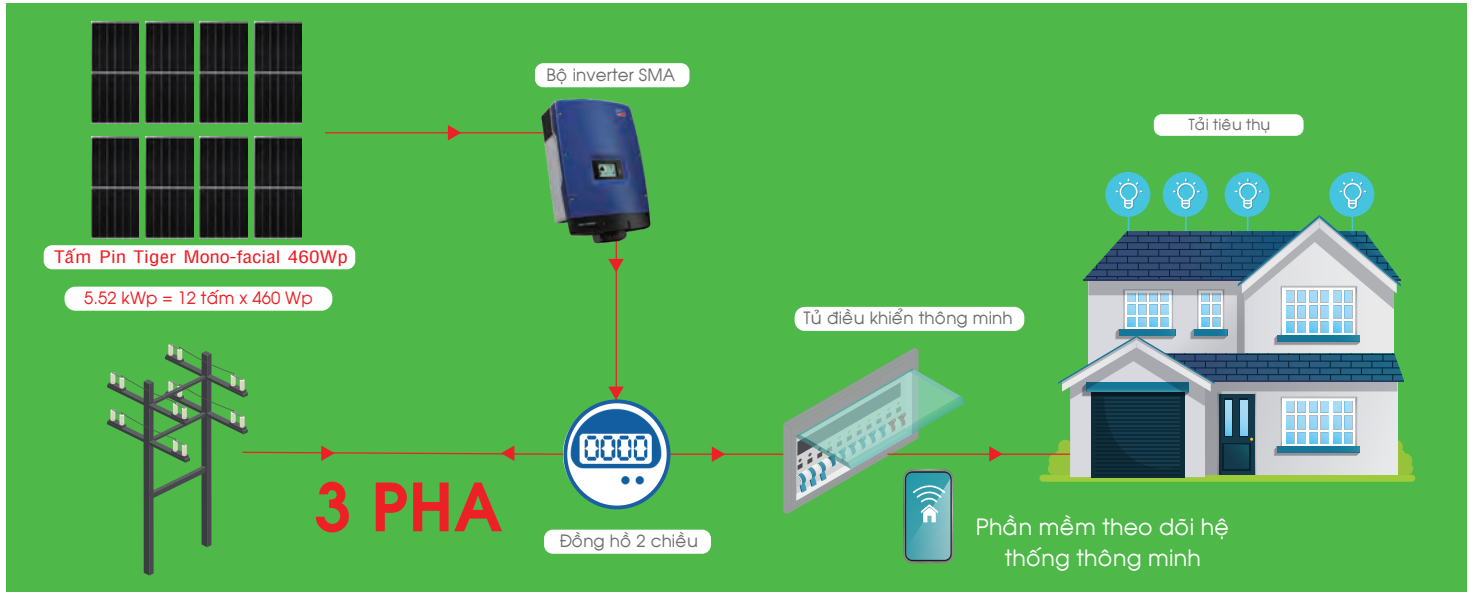

**GIÁ TRỌN GÓI (BH 5 năm): 136,4 TRIỆU VNĐ (Đã bao gồm VAT, chi phí vận chuyển và lắp đặt)**

**GIÁ TRỌN GÓI (BH 10 năm): 143 TRIỆU VNĐ (Đã bao gồm VAT, chi phí vận chuyển và lắp đặt)**

Sản phẩm	Thông số chi tiết	Đơn vị tính	Số lượng	Bảo hành
<b>Tấm Pin Tiger Mono-facial 460Wp</b> 	<ul style="list-style-type: none"> <li>- Tấm pin Jinko</li> <li>- Model: Tiger Mono-facial (JKM460-7RL3-V)</li> <li>- Kích thước: 2182 x 1029 x 40mm</li> <li>- Trọng lượng: 26.1 kg</li> <li>- Mặt trước: Kính cường lực 3.2mm</li> <li>- Khung: Hợp kim Nhôm Anod</li> <li>- Hộp nối: IP67</li> <li>- Cấp DC: 1x 4.0mm2</li> <li>- Công suất: <b>460Wp</b></li> <li>- Điện áp ở công suất cực đại: 43.08VDC</li> <li>- Dòng điện ở công suất cực đại: 10.68A</li> <li>- Điện áp hở mạch: 51.7VDC</li> <li>- Dòng điện ngắn mạch: 11.5A</li> <li>- Hiệu suất chuyển đổi quang năng: 20.49%</li> <li>- Nhiệt độ làm việc: âm 40°C đến 85°C</li> <li>- Dung sai công suất: 0~+3%</li> </ul>	Tấm	12	5 năm/10 năm
<b>Inverter</b> 	<ul style="list-style-type: none"> <li>- Inverter SMA</li> <li>- Model: STP-5000TL</li> <li>- Công suất đầu vào tối đa: 9000Wp</li> <li>- Điện áp DC đầu vào tối đa: 850VDC</li> <li>- Công suất đầu ra tối đa (400V/50Hz): 5000W</li> <li>- Điện áp AC: 230/400V</li> <li>- Dòng AC max: 3x7.6A</li> <li>- Hiệu suất chuyển đổi MAX/tiêu chuẩn EU: 98,2% / 97.4%</li> <li>- Kết nối PC, máy tính bảng, smart phone theo dõi số liệu kỹ thuật</li> </ul>	Bộ	1	5 năm/10 năm
<b>Khung, giá đỡ</b> 	<ul style="list-style-type: none"> <li>- Kẹp, thanh ray Schletter - Đức</li> </ul>	Bộ	1	5 năm/10 năm
<b>Dây cáp DC</b> 	<ul style="list-style-type: none"> <li>- Cáp DC tiêu chuẩn Châu Âu</li> </ul>	Bộ	1	5 năm/10 năm
<ul style="list-style-type: none"> <li>- Hệ thống đã bao gồm tủ điều khiển: Vỏ tủ, MCB, cầu chì, cáp AC</li> </ul>		Bộ	1	5 năm/10 năm

Trong một số trường hợp đặc biệt, công ty sẽ khảo sát và báo giá cụ thể theo thực tế

Quý khách sử dụng Pin 390Wp (JKM390M-72) sẽ giảm 5%

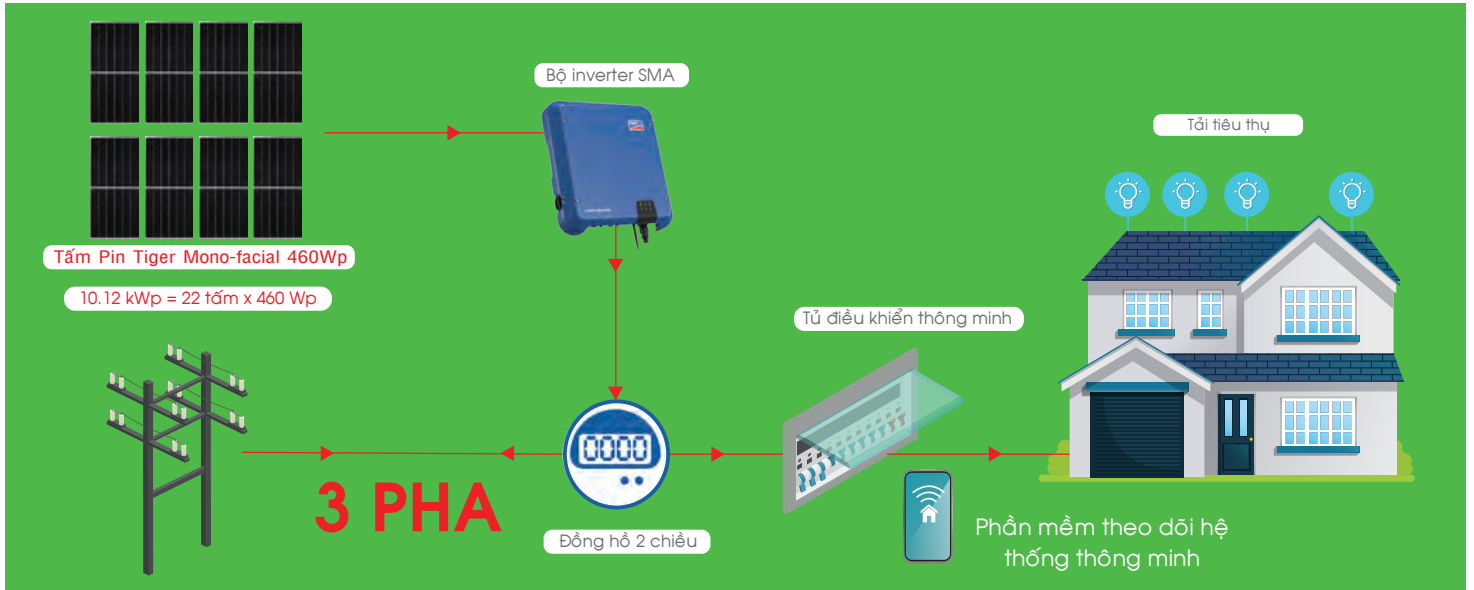

**GIÁ TRỌN GÓI (BH 5 năm): 243,1 TRIỆU VNĐ (Đã bao gồm VAT, chi phí vận chuyển và lắp đặt)**

**GIÁ TRỌN GÓI (BH 10 năm): 251,9 TRIỆU VNĐ (Đã bao gồm VAT, chi phí vận chuyển và lắp đặt)**

Sản phẩm	Thông số chi tiết	Đơn vị tính	Số lượng	Bảo hành
<b>Tấm Pin Tiger Mono-facial 460Wp</b> 	<ul style="list-style-type: none"> <li>- Tấm pin JinkO</li> <li>- Model: Tiger Mono-facial (JKM460-7RL3-V)</li> <li>- Kích thước: 2182 x 1029 x 40mm</li> <li>- Trọng lượng: 26.1 kg</li> <li>- Mặt trước: Kính cường lực 3.2mm</li> <li>- Khung: Hộp kim Nhôm Anod</li> <li>- Hộp nối: IP67</li> <li>- Cấp DC: 1x 4.0mm<sup>2</sup></li> <li>- Công suất: <b>460Wp</b></li> <li>- Điện áp ở công suất cực đại: 43.08VDC</li> <li>- Dòng điện ở công suất cực đại: 10.68A</li> <li>- Điện áp hở mạch: 51.7VDC</li> <li>- Dòng điện ngắn mạch: 11.5A</li> <li>- Hiệu suất chuyển đổi quang năng: 20.49%</li> <li>- Nhiệt độ làm việc: âm 40°C đến 85°C</li> <li>- Dung sai công suất: 0~+3%</li> </ul>	Tấm	22	5 năm/10 năm
	<ul style="list-style-type: none"> <li>- Inverter SMA</li> <li>- Model: STP-10.0-3AV</li> <li>- Công suất đầu vào tối đa: 15000Wp</li> <li>- Điện áp DC đầu vào tối đa: 1000VDC</li> <li>- Công suất đầu ra tối đa (400V/50Hz): 10000W</li> <li>- Điện áp AC: 230/400V</li> <li>- Dòng AC max: 3x14.5A</li> <li>- Hiệu suất chuyển đổi MAX/tiêu chuẩn EU: 98,3% / 98%</li> <li>- Kết nối PC, máy tính bảng, smart phone theo dõi số liệu kỹ thuật</li> </ul>	Bộ	1	5 năm/10 năm
<b>Khung, giá đỡ</b> 	<ul style="list-style-type: none"> <li>- Kẹp, thanh ray Schletter - Đức</li> </ul>	Bộ	1	5 năm/10 năm
	<ul style="list-style-type: none"> <li>- Cáp DC tiêu chuẩn Châu Âu</li> </ul>	Bộ	1	5 năm/10 năm
- Hệ thống đã bao gồm tủ điều khiển: Vỏ tủ, MCB, cầu chì, cáp AC		Bộ	1	5 năm/10 năm

Trong một số trường hợp đặc biệt, công ty sẽ khảo sát và báo giá cụ thể theo thực tế

Quý khách sử dụng Pin 390Wp (JKM390M-72) sẽ giảm 5%





**GIÁ TRỌN GÓI (BH 5 năm): 342,1 TRIỆU VNĐ (Đã bao gồm VAT, chi phí vận chuyển và lắp đặt)**

**GIÁ TRỌN GÓI (BH 10 năm): 353,1 TRIỆU VNĐ (Đã bao gồm VAT, chi phí vận chuyển và lắp đặt)**

Sản phẩm	Thông số chi tiết	Đơn vị tính	Số lượng	Bảo hành
<b>Tấm Pin Tiger Mono-facial 460Wp</b> 	<ul style="list-style-type: none"> <li>- Tấm pin Jinko</li> <li>- Model: Tiger Mono-facial (JKM460-7RL3-V)</li> <li>- Kích thước: 2182 x 1029 x 40mm</li> <li>- Trọng lượng: 26.1 kg</li> <li>- Mặt trước: Kính cường lực 3.2mm</li> <li>- Khung: Hợp kim Nhôm Anod</li> <li>- Hộp nối: IP67</li> <li>- Cáp DC: 1x 4.0mm2</li> <li>- Công suất: <b>460Wp</b></li> <li>- Điện áp ở công suất cực đại: 43.08VDC</li> <li>- Dòng điện ở công suất cực đại: 10.68A</li> <li>- Điện áp hở mạch: 51.7VDC</li> <li>- Dòng điện ngắn mạch: 11.5A</li> <li>- Hiệu suất chuyển đổi quang năng: 20.49%</li> <li>- Nhiệt độ làm việc: âm 40°C đến 85°C</li> <li>- Dung sai công suất: 0~+3%</li> </ul>	Tấm	34	5 năm/10 năm
<b>Inverter</b> 	<ul style="list-style-type: none"> <li>- Inverter SMA</li> <li>- Model: STP-15000TL</li> <li>- Công suất đầu vào tối đa: 27000Wp</li> <li>- Điện áp DC đầu vào tối đa: 1000V</li> <li>- Công suất đầu ra tối đa (400V/50Hz): 15000W</li> <li>- Điện áp AC: 230/400V</li> <li>- Dòng AC max: 29A</li> <li>- Hiệu suất chuyển đổi MAX/tiêu chuẩn EU: 98.4% / 98%</li> <li>- Kết nối PC, máy tính bảng, smart phone theo dõi số liệu kỹ thuật</li> </ul>	Bộ	1	5 năm/10 năm
<b>Khung, giá đỡ</b> 	<ul style="list-style-type: none"> <li>- Kẹp, thanh ray Schletter - Đức</li> </ul>	Bộ	1	5 năm/10 năm
<b>Dây cáp DC</b> 	<ul style="list-style-type: none"> <li>- Cáp DC tiêu chuẩn Châu Âu</li> </ul>	Bộ	1	5 năm/10 năm
<ul style="list-style-type: none"> <li>- Hệ thống đã bao gồm tủ điều khiển: Vô tủ, MCB, cầu chì, cáp AC</li> </ul>		Bộ	1	5 năm/10 năm

Trong một số trường hợp đặc biệt, công ty sẽ khảo sát và báo giá cụ thể theo thực tế  
 Quý khách sử dụng Pin 390Wp (JKM390M-72) sẽ giảm 5%



**GIÁ TRỌN GÓI (BH 5 năm): 462 TRIỆU VNĐ (Đã bao gồm VAT, chi phí vận chuyển và lắp đặt)**

**GIÁ TRỌN GÓI (BH 10 năm): 476,3 TRIỆU VNĐ (Đã bao gồm VAT, chi phí vận chuyển và lắp đặt)**

Sản phẩm	Thông số chi tiết	Đơn vị tính	Số lượng	Bảo hành
<b>Tấm Pin Tiger Mono-facial 460Wp</b> 	<ul style="list-style-type: none"> <li>- Tấm pin Jinko</li> <li>- Model: Tiger Mono-facial (JKM460-7RL3-V)</li> <li>- Kích thước: 2182 x 1029 x 40mm</li> <li>- Trọng lượng: 26.1 kg</li> <li>- Mặt trước: Kính cường lực 3.2mm</li> <li>- Khung: Hợp kim Nhôm Anod</li> <li>- Hộp nối: IP67</li> <li>- Cáp DC: 1x 4.0mm<sup>2</sup></li> <li>- Công suất: <b>460Wp</b></li> <li>- Điện áp ở công suất cực đại: 43.08VDC</li> <li>- Dòng điện ở công suất cực đại: 10.68A</li> <li>- Điện áp hở mạch: 51.7VDC</li> <li>- Dòng điện ngắn mạch: 11.5A</li> <li>- Hiệu suất chuyển đổi quang năng: 20.49%</li> <li>- Nhiệt độ làm việc: âm 40°C đến 85°C</li> <li>- Dung sai công suất: 0~+3%</li> </ul>	Tấm	44	5 năm/10 năm
<b>Inverter</b> 	<ul style="list-style-type: none"> <li>- Inverter SMA</li> <li>- Model: STP-20000TL</li> <li>- Công suất đầu vào tối đa: 36000Wp</li> <li>- Điện áp DC đầu vào tối đa: 1000V</li> <li>- Công suất đầu ra tối đa (400V/50Hz): 20000W</li> <li>- Điện áp AC: 230/400V</li> <li>- Dòng AC max: 29A</li> <li>- Hiệu suất chuyển đổi MAX/tiêu chuẩn EU: 98.4% / 98%</li> <li>- Kết nối PC, máy tính bảng, smart phone theo dõi số liệu kỹ thuật</li> </ul>	Bộ	1	5 năm/10 năm
<b>Khung, giá đỡ</b> 	<ul style="list-style-type: none"> <li>- Kẹp, thanh ray Schletter - Đức</li> </ul>	Bộ	1	5 năm/10 năm
<b>Dây cáp DC</b> 	<ul style="list-style-type: none"> <li>- Cáp DC tiêu chuẩn Châu Âu</li> </ul>	Bộ	1	5 năm/10 năm
<ul style="list-style-type: none"> <li>- Hệ thống đã bao gồm tủ điều khiển: Vô tủ, MCB, cầu chì, cáp AC</li> </ul>		Bộ	1	5 năm/10 năm

Trong một số trường hợp đặc biệt, công ty sẽ khảo sát và báo giá cụ thể theo thực tế  
 Quý khách sử dụng Pin 390Wp (JKM390M-72) sẽ giảm 5%

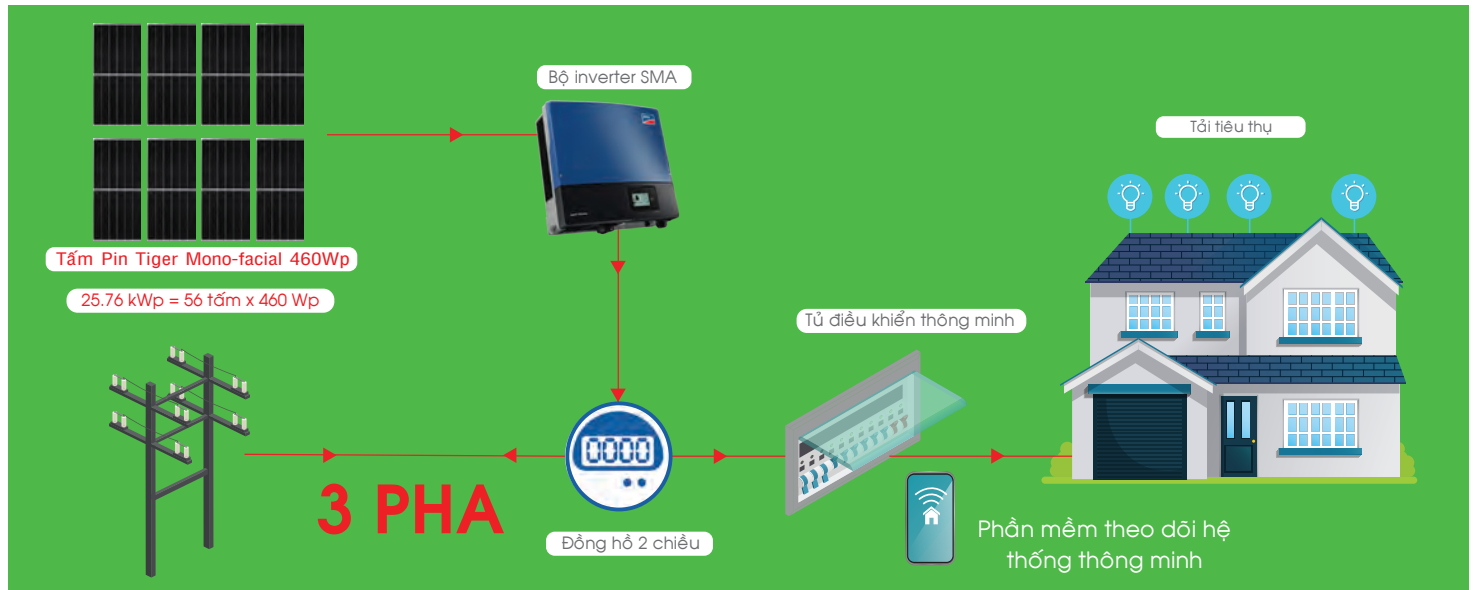

**GIÁ TRỌN GÓI (BH 5 năm): 519,2 TRIỆU VNĐ (Đã bao gồm VAT, chi phí vận chuyển và lắp đặt)**

**GIÁ TRỌN GÓI (BH 10 năm): 532,4 TRIỆU VNĐ (Đã bao gồm VAT, chi phí vận chuyển và lắp đặt)**

Sản phẩm	Thông số chi tiết	Đơn vị tính	Số lượng	Bảo hành
<b>Tấm Pin Tiger Mono-facial 460Wp</b> 	<ul style="list-style-type: none"> <li>- Tấm pin Jinko</li> <li>- Model: Tiger Mono-facial (JKM460-7RL3-V)</li> <li>- Kích thước: 2182 x 1029 x 40mm</li> <li>- Trọng lượng: 26.1 kg</li> <li>- Mặt trước: Kính cường lực 3.2mm</li> <li>- Khung: Hợp kim Nhôm Anod</li> <li>- Hộp nối: IP67</li> <li>- Cáp DC: 1x 4.0mm2</li> <li>- Công suất: <b>460Wp</b></li> <li>- Điện áp ở công suất cực đại: 43.08VDC</li> <li>- Dòng điện ở công suất cực đại: 10.68A</li> <li>- Điện áp hở mạch: 51.7VDC</li> <li>- Dòng điện ngắn mạch: 11.5A</li> <li>- Hiệu suất chuyển đổi quang năng: 20.49%</li> <li>- Nhiệt độ làm việc: âm 40°C đến 85°C</li> <li>- Dung sai công suất: 0~+3%</li> </ul>	Tấm	56	5 năm/10 năm
<b>Inverter</b> 	<ul style="list-style-type: none"> <li>- Inverter SMA</li> <li>- Model: STP-25000TL</li> <li>- Công suất đầu vào tối đa: 45000Wp</li> <li>- Điện áp DC đầu vào tối đa: 1000V</li> <li>- Công suất đầu ra tối đa (400V/50Hz): 25000W</li> <li>- Điện áp AC: 230/400V</li> <li>- Dòng AC max: 36.2A</li> <li>- Hiệu suất chuyển đổi MAX/tiêu chuẩn EU: 98.3% / 98.1%</li> <li>- Kết nối PC, máy tính bảng, smart phone theo dõi số liệu kỹ thuật</li> </ul>	Bộ	1	5 năm/10 năm
<b>Khung, giá đỡ</b> 	<ul style="list-style-type: none"> <li>- Kẹp, thanh ray Schletter - Đức</li> </ul>	Bộ	1	5 năm/10 năm
<b>Dây cáp DC</b> 	<ul style="list-style-type: none"> <li>- Cáp DC tiêu chuẩn Châu Âu</li> </ul>	Bộ	1	5 năm/10 năm
<ul style="list-style-type: none"> <li>- Hệ thống đã bao gồm tủ điều khiển: Vỏ tủ, MCB, cầu chì, cáp AC</li> </ul>		Bộ	1	5 năm/10 năm

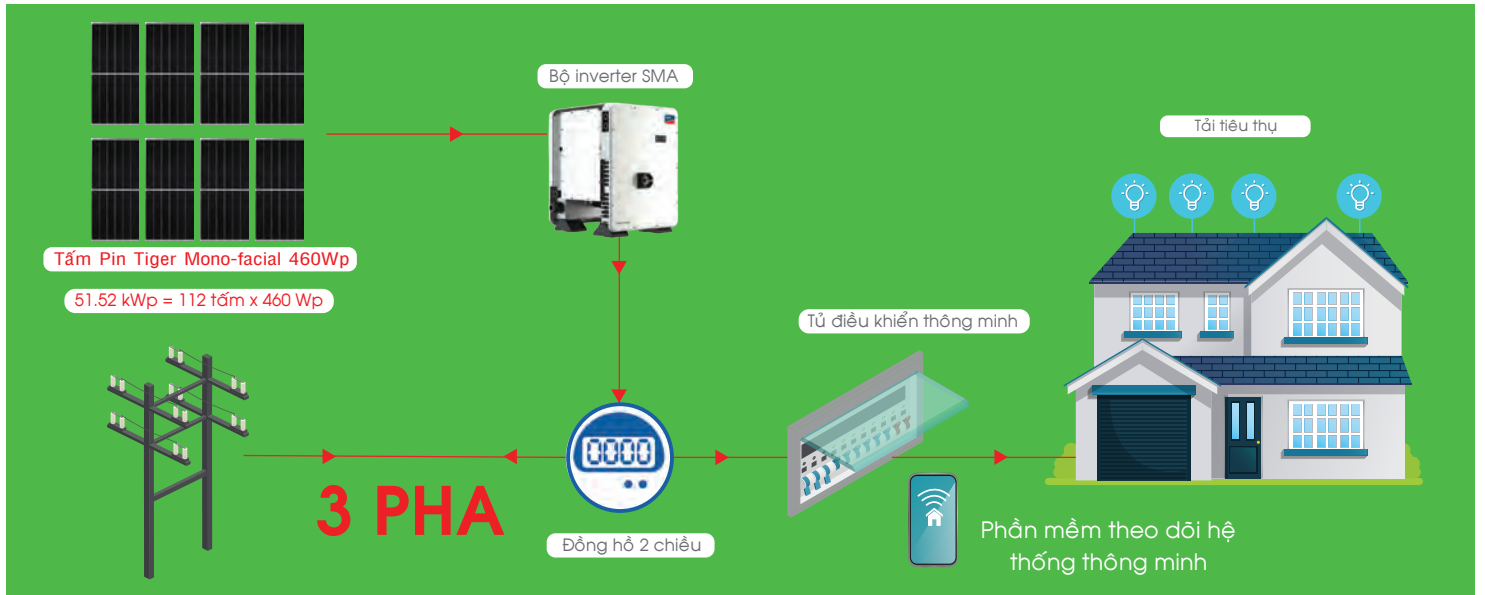

Trong một số trường hợp đặc biệt, công ty sẽ khảo sát và báo giá cụ thể theo thực tế

Quý khách sử dụng Pin 390Wp (JKM390M-72) sẽ giảm 5%



**GIÁ TRỌN GÓI (BH 5 năm): 1 TỶ 014,2 TRIỆU VNĐ (Đã bao gồm VAT, chi phí vận chuyển và lắp đặt)**

**GIÁ TRỌN GÓI (BH 10 năm): 1 TỶ 031,8 TRIỆU VNĐ (Đã bao gồm VAT, chi phí vận chuyển và lắp đặt)**

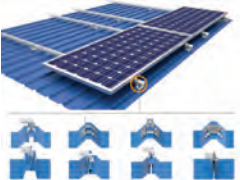
Sản phẩm	Thông số chi tiết	Đơn vị tính	Số lượng	Bảo hành
<b>Tấm Pin Tiger Mono-facial 460Wp</b> 	<ul style="list-style-type: none"> <li>- Tấm pin Jinko</li> <li>- Model: Tiger Mono-facial (JKM460-7RL3-V)</li> <li>- Kích thước: 2182 x 1029 x 40mm</li> <li>- Trọng lượng: 26.1 kg</li> <li>- Mặt trước: Kính cường lực 3.2mm</li> <li>- Khung: Hợp kim Nhôm Anod</li> <li>- Hộp nối: IP67</li> <li>- Cáp DC: 1x 4.0mm2</li> <li>- Công suất: <b>460Wp</b></li> <li>- Điện áp ở công suất cực đại: 43.08VDC</li> <li>- Dòng điện ở công suất cực đại: 10.68A</li> <li>- Điện áp hở mạch: 51.7VDC</li> <li>- Dòng điện ngắn mạch: 11.5A</li> <li>- Hiệu suất chuyển đổi quang năng: 20.49%</li> <li>- Nhiệt độ làm việc: âm 40°C đến 85°C</li> <li>- Dung sai công suất: 0~+3%</li> </ul>	Tấm	112	5 năm/10 năm
<b>Inverter</b> 	<ul style="list-style-type: none"> <li>- Inverter SMA</li> <li>- Model: STP50-40</li> <li>- Công suất đầu vào tối đa: 75000Wp</li> <li>- Điện áp DC đầu vào tối đa: 1000V</li> <li>- Công suất đầu ra tối đa (400V/50Hz): 50000W</li> <li>- Điện áp AC: 230/400V</li> <li>- Dòng AC max: 72.5A</li> <li>- Hiệu suất chuyển đổi MAX/tiêu chuẩn EU: 98.1% / 97.8%</li> <li>- Kết nối PC, máy tính bảng, smart phone theo dõi số liệu kỹ thuật</li> </ul>	Bộ	1	5 năm/10 năm
<b>Khung, giá đỡ</b> 	<ul style="list-style-type: none"> <li>- Kẹp, thanh ray Schletter - Đức</li> </ul>	Bộ	1	5 năm/10 năm
<b>Dây cáp DC</b> 	<ul style="list-style-type: none"> <li>- Cáp DC tiêu chuẩn Châu Âu</li> </ul>	Bộ	1	5 năm/10 năm
<ul style="list-style-type: none"> <li>- Hệ thống đã bao gồm tủ điều khiển: Vô tủ, MCB, cầu chì, cáp AC</li> </ul>		Bộ	1	5 năm/10 năm

Trong một số trường hợp đặc biệt, công ty sẽ khảo sát và báo giá cụ thể theo thực tế  
 Quý khách sử dụng Pin 390Wp (JKM390M-72) sẽ giảm 5%

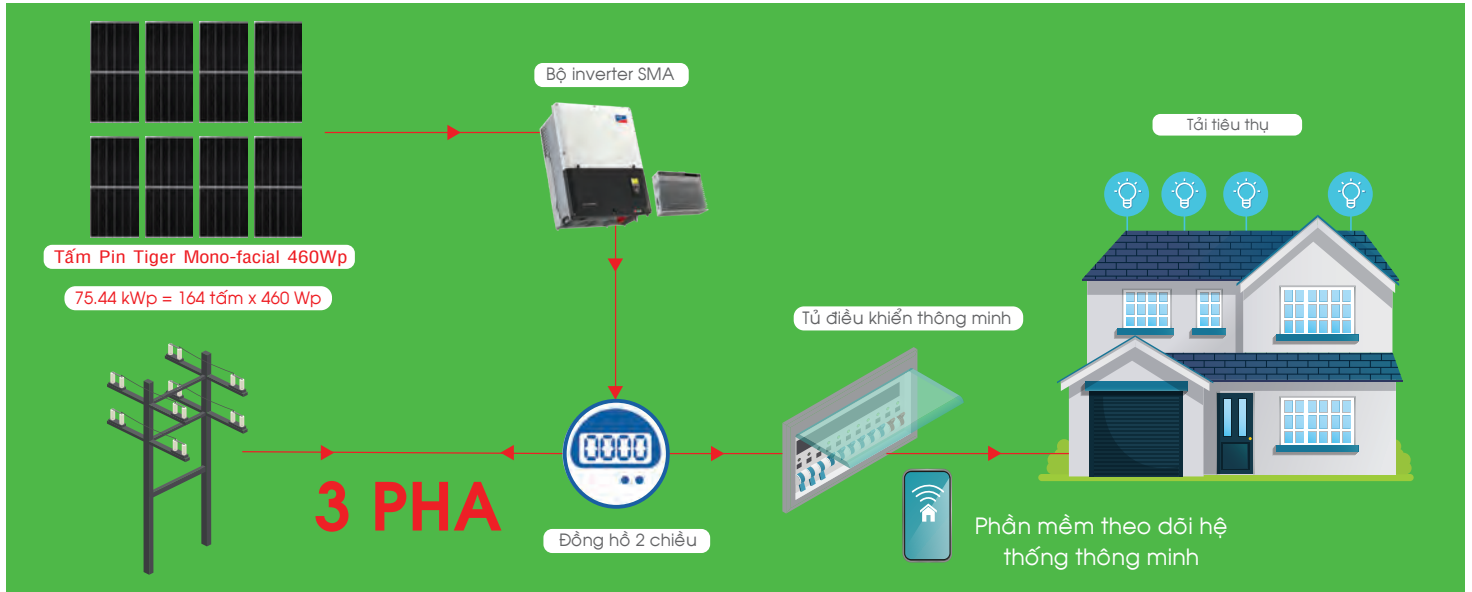

**GIÁ TRỌN GÓI (BH 5 năm): 1 TỶ 489,4 TRIỆU VNĐ (Đã bao gồm VAT, chi phí vận chuyển và lắp đặt)**  
**GIÁ TRỌN GÓI (BH 10 năm): 1 TỶ 518 TRIỆU VNĐ (Đã bao gồm VAT, chi phí vận chuyển và lắp đặt)**

Sản phẩm	Thông số chi tiết	Đơn vị tính	Số lượng	Bảo hành
<b>Tấm Pin Tiger Mono-facial 460Wp</b> 	<ul style="list-style-type: none"> <li>- Tấm pin JinKO</li> <li>- Model: Tiger Mono-facial (JKM460-7RL3-V)</li> <li>- Kích thước: 2182 x 1029 x 40mm</li> <li>- Trọng lượng: 26.1 kg</li> <li>- Mặt trước: Kính cường lực 3.2mm</li> <li>- Khung: Hợp kim Nhôm Anod</li> <li>- Hộp nối: IP67</li> <li>- Cáp DC: 1x 4.0mm2</li> <li>- Công suất: <b>460Wp</b></li> <li>- Điện áp ở công suất cực đại: 43.08VDC</li> <li>- Dòng điện ở công suất cực đại: 10.68A</li> <li>- Điện áp hở mạch: 51.7VDC</li> <li>- Dòng điện ngắn mạch: 11.5A</li> <li>- Hiệu suất chuyển đổi quang năng: 20.49%</li> <li>- Nhiệt độ làm việc: âm 40°C đến 85°C</li> <li>- Dung sai công suất: 0~+3%</li> </ul>	Tấm	164	5 năm/10 năm
<b>Inverter</b> 	<ul style="list-style-type: none"> <li>- Inverter SMA</li> <li>- Model: SHP75-10</li> <li>- Công suất đầu vào tối đa: 112500Wp</li> <li>- Điện áp DC đầu vào tối đa: 1000V</li> <li>- Công suất đầu ra tối đa (400V/50Hz): 75000W</li> <li>- Điện áp AC: 230/400V</li> <li>- Dòng AC max: 109A</li> <li>- Hiệu suất chuyển đổi MAX/tiêu chuẩn EU: 98.8% / 98.2%</li> <li>- Kết nối PC, máy tính bảng, smart phone theo dõi số liệu kỹ thuật</li> </ul>	Bộ	1	5 năm/10 năm
<b>Khung, giá đỡ</b> 	<ul style="list-style-type: none"> <li>- Kẹp, thanh ray Schletter - Đức</li> </ul>	Bộ	1	5 năm/10 năm
<b>Dây cáp DC</b> 	<ul style="list-style-type: none"> <li>- Cáp DC tiêu chuẩn Châu Âu</li> </ul>	Bộ	1	5 năm/10 năm
<ul style="list-style-type: none"> <li>- Hệ thống đã bao gồm tủ điều khiển: Vỏ tủ, MCB, cầu chì, cáp AC</li> </ul>		Bộ	1	5 năm/10 năm

Trong một số trường hợp đặc biệt, công ty sẽ khảo sát và báo giá cụ thể theo thực tế  
 Quý khách sử dụng Pin 390Wp (JKM390M-72) sẽ giảm 5%

# Tấm Pin năng lượng mặt trời

- Các tấm pin Jinko Solar thế hệ mới được ứng dụng công nghệ 9 thanh dẫn và công nghệ Tilling-Ribbon nhằm giảm thiểu tổn hao điện năng và loại bỏ khoảng trống giữa các tế bào quang điện. Qua đó nâng hiệu suất lên đến 20.93% cho tấm pin Mono-facial.
- Với hệ thống 9 thanh dẫn, các tế bào quang điện được chia nhỏ hơn. Công nghệ mới giúp thanh dẫn trụ tròn của Jinko có độ dẻo cao. Nhờ đó hiện tượng vi nứt (micro crack) được hạn chế giúp tăng độ bền và độ tin cậy của tấm pin gấp nhiều lần.
- Jinko Solar hợp tác với DuPont Tedlar (Hoa Kỳ) để tạo ra lớp phủ mặt sau vượt trội về khả năng chống chịu thời tiết. Với nhiều sản phẩm đã được kiểm nghiệm trên 40 năm, lớp phủ mặt sau DuPont Tedlar đảm bảo không bị ố vàng theo thời gian, giảm mức độ gia nhiệt do Mặt Trời, từ đó giảm suy hao công suất mỗi năm chỉ còn 0.6%.
- Sản phẩm của Jinko Solar được bảo hành 12 năm và bảo hành hiệu suất 25 năm. Cam kết bảo hành được chứng nhận bởi đơn vị bảo hiểm uy tín từ Mỹ (Power Guard) và Thụy Sĩ (Ariel Re).

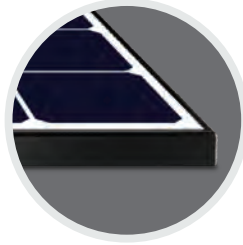

Khung viền làm bằng hợp kim cao cấp

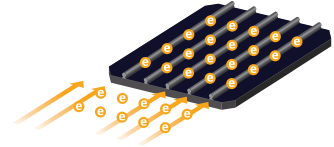

Số lượng kết nối tăng lên giúp giảm tổn thất năng lượng

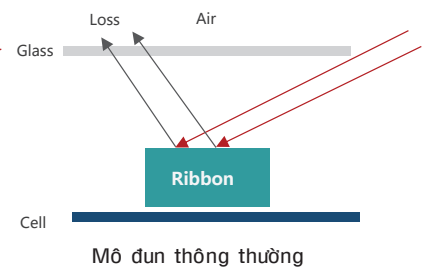
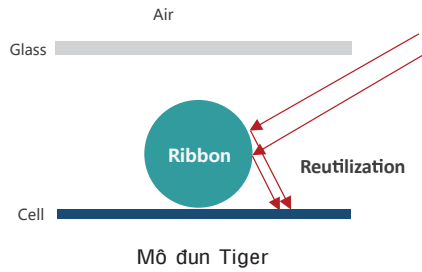

Jinko Solar

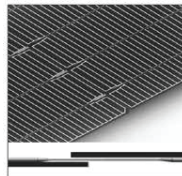

Thanh dẫn được ép dẹt tại điểm xếp chồng

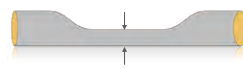

Thanh dẫn độ dẻo cao được ép dẹt giúp tăng độ bền cơ học của tế bào quang điện

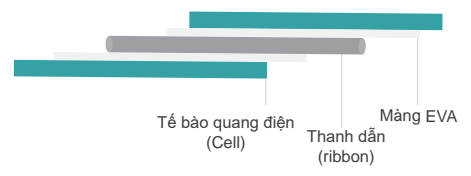

Các thanh dẫn Ribbon trụ tròn giúp tăng khả năng hấp thụ ánh sáng

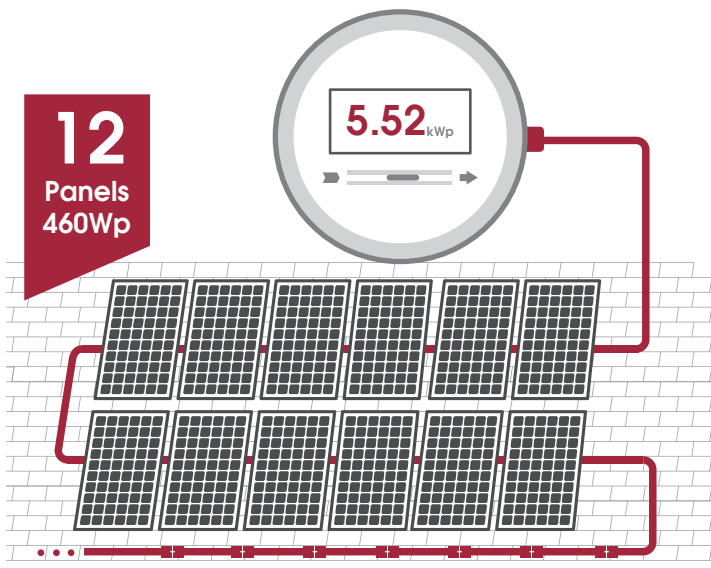

Không gian lắp đặt khoảng 27.7m<sup>2</sup>

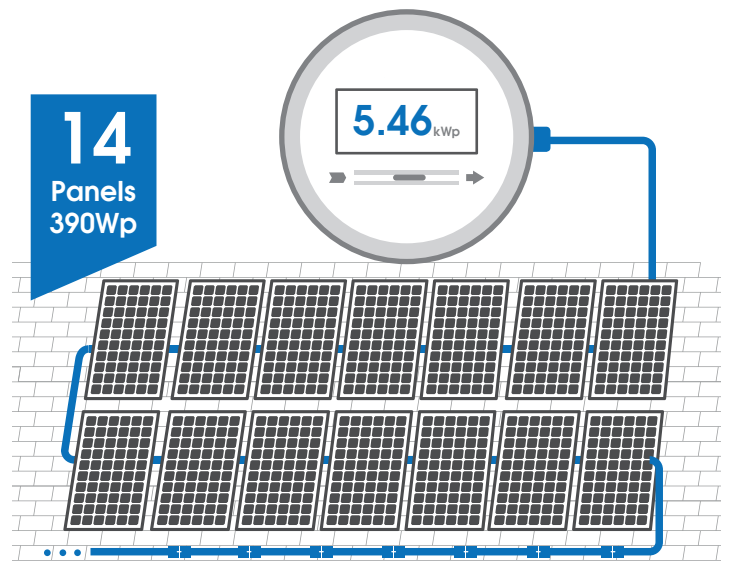

Không gian lắp đặt khoảng 29m<sup>2</sup>

## Tấm Pin năng lượng mặt trời

Hình ảnh	Thông số chi tiết	Đơn giá (VNĐ)
 <p><b>Cheetah HC 72M-V 390W</b> Mono PERC module Positive power tolerance of 0~+3% - Mono PERC 72 Cell</p>	Mã hàng	JKM390M-72-V
	Kích thước	1979x1002x40mm
	Trọng lượng	22.5 kg
	Mặt trước	Kính cường lực 3.2mm
	Khung	Hợp kim Nhôm Anod
	Hộp nối	IP67
	Cáp DC	1x4.0mm <sup>2</sup>
	Công suất đỉnh	390Wp
	Điện áp ở công suất cực đại	41.4VDC
	Dòng điện ở công suất cực đại	9.49A
	Điện áp tối đa của hệ thống	1500VDC
	Dòng lớn nhất của cầu chì bảo vệ	20A
	Điện áp hở mạch	49.3VDC
	Dòng điện ngắn mạch	10.12A
	Hiệu suất chuyển đổi quang năng	19.38%
	Nhiệt độ làm việc	-40°C ~ 85°C
Dung sai công suất	0~+3%	
Thời gian bảo hành	12 năm	
Giá đã bao gồm VAT 10%		<b>4.330.700</b>

Hình ảnh	Thông số chi tiết	Đơn giá (VNĐ)
 <p><b>Cheetah HC 72M-V 410W</b> Mono PERC half Cell module Positive power tolerance of 0~+3% - Half Cell - Mono PERC 72 Cell</p>	Mã hàng	JKM410M-72H-V
	Kích thước	2008x1002x40mm
	Trọng lượng	22.5 kg
	Mặt trước	Kính cường lực 3.2mm
	Khung	Hợp kim Nhôm Anod
	Hộp nối	IP67
	Cáp DC	1x4.0mm <sup>2</sup>
	Công suất đỉnh	410Wp
	Điện áp ở công suất cực đại	42.3VDC
	Dòng điện ở công suất cực đại	9.69A
	Điện áp tối đa của hệ thống	1500VDC
	Dòng lớn nhất của cầu chì bảo vệ	20A
	Điện áp hở mạch	50.4VDC
	Dòng điện ngắn mạch	10.60A
	Hiệu suất chuyển đổi quang năng	20.38%
	Nhiệt độ làm việc	-40°C ~ 85°C
Dung sai công suất	0~+3%	
Thời gian bảo hành	12 năm	
Giá đã bao gồm VAT 10%		<b>4.897.200</b>

## Tấm Pin năng lượng mặt trời



Hình ảnh	Thông số chi tiết	Đơn giá (VNĐ)
 <p><b>Cheetah Plus HC 78M 445W</b> Mono PERC half Cell module Positive power tolerance of 0~+3% - Half Cell - Mono PERC 78 Cell</p>	Mã hàng	JKM445M-78H-V
	Kích thước	2167x998x40mm
	Trọng lượng	24.3 kg
	Mặt trước	Kính cường lực 3.2mm
	Khung	Hộp kim Nhôm Anod
	Hộp nối	IP67
	Cáp DC	1x4.0mm <sup>2</sup>
	Công suất đỉnh	445Wp
	Điện áp ở công suất cực đại	43.72VDC
	Dòng điện ở công suất cực đại	10.18A
	Điện áp tối đa của hệ thống	1500VDC
	Dòng lớn nhất của cầu chì bảo vệ	20A
	Điện áp hở mạch	52.04VDC
	Dòng điện ngắn mạch	10.84A
	Hiệu suất chuyển đổi quang năng	20.38%
Nhiệt độ làm việc	-40°C ~ 85°C	
Dung sai công suất	0~+3%	
Thời gian bảo hành	12 năm	
Giá đã bao gồm VAT 10%		<b>5.315.200</b>

Hình ảnh	Thông số chi tiết	Đơn giá (VNĐ)
 <p><b>Tiger Mono-facial 460W</b> Tiling Ribbon (TR) Technology Positive power tolerance of 0~+3%</p>	Mã hàng	JKM460M-7RL3-V
	Kích thước	2182x1029x40mm
	Trọng lượng	26.1 kg
	Mặt trước	Kính cường lực 3.2mm
	Khung	Hộp kim Nhôm Anod
	Hộp nối	IP67
	Cáp DC	1x4.0mm <sup>2</sup>
	Công suất đỉnh	460Wp
	Điện áp ở công suất cực đại	43.08VDC
	Dòng điện ở công suất cực đại	10.68A
	Điện áp tối đa của hệ thống	1500VDC
	Dòng lớn nhất của cầu chì bảo vệ	20A
	Điện áp hở mạch	51.70VDC
	Dòng điện ngắn mạch	11.50A
	Hiệu suất chuyển đổi quang năng	20.49%
Nhiệt độ làm việc	-40°C ~ 85°C	
Dung sai công suất	0~+3%	
Thời gian bảo hành	12 năm	
Giá đã bao gồm VAT 10%		<b>5.494.500</b>



## Thiết bị Inverter SMA

Bộ chuyển đổi Inverter	Mã hàng Model	Số pha	Công suất đầu ra AC	Điện áp đầu vào DC	Đơn giá (VNĐ)	
					Bảo hành 5 năm	Bảo hành 10 năm
	SB-3000TL	1 pha	3000W	750 VDC	31.350.000	36.300.000
	SB-5.0-1AV	1 pha	5000W	600 VDC	40.150.000	46.200.000
	STP-5000TL	3 pha	5000W	1000 VDC	50.600.000	57.200.000
	STP-10.0-3AV	3 pha	10.000W	1000 VDC	74.800.000	83.600.000
	STP-15000TL	3 pha	15.000W	1000 VDC	95.700.000	106.700.000
	STP-20000TL	3 pha	20.000W	1000 VDC	101.750.000	115.500.000
	STP-25000TL	3 pha	25.000W	1000 VDC	104.500.000	117.700.000
	STP50-40	3 pha	50.000W	1000 VDC	177.100.000	194.700.000
	SHP75-10	3 pha	75.000W	1000 VDC	181.500.000	205.700.000
	STP110-60	3 pha	110.000W	1000 VDC	264.000.000	299.200.000

Phụ kiện Inverter	Mã hàng Model	Diễn giải	Bảo hành 5 năm	Bảo hành 10 năm
	IM-20	<b>Inverter Manager (Dùng cho Inverter 75kW &amp; 110kW)</b> - Số lượng inverter : 200 bộ - Công suất tiêu thụ : 4W - Cổng kết nối dữ liệu : - Tiêu chuẩn bảo vệ : IP20 2xRJ45, 1xUSB 2.0 (Type A), - Trọng lượng : 220g LAN - Lắp đặt trong nhà	97.900.000	116.600.000
	DCC-14	<b>DC Combinerbox (Dùng cho Inverter 75kW)</b> - Số cổng đầu vào : 14 - Số cổng đầu ra : 1 - Điện áp ngõ vào tối đa : 1000V DC - Kích thước : 600x600x225mm	35.200.000	40.700.000
	EDMM-10	<b>Data Manager (Dùng cho Inverter 110kW)</b> - Số lượng inverter : 50 bộ - Công suất tiêu thụ : 4W - Công suất tối đa : 2.5MW - Tiêu chuẩn bảo vệ : IP20 - Cổng kết nối dữ liệu : - Trọng lượng : 220g 2xRJ45, 1xUSB 2.0 (Type A), - Lắp đặt trong nhà WLAN	40.700.000	46.200.000

Giá đã bao gồm VAT 10%

# Khung, giá đỡ Solar

## Ứng dụng từng loại

Vật liệu: nhôm định hình, sắt mạ kẽm, tôn kẽm, sơn kẽm, sơn Epoxy, Inox

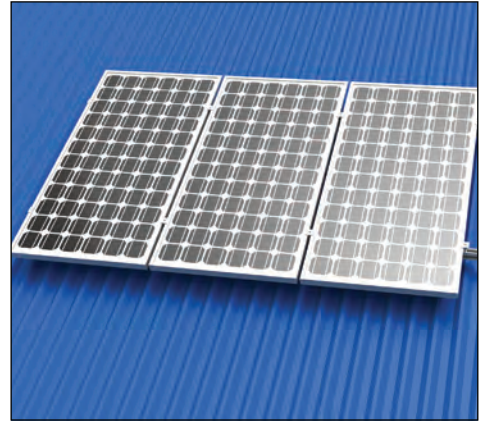
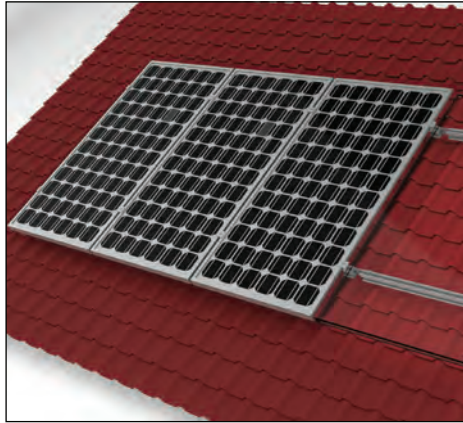

1. Khung lắp đặt trên mái bằng

2. Khung lắp đặt trên mái ngói

3. Khung lắp đặt trên mái tole

Căn cứ từng khu vực lắp đặt cụ thể, từ đó phần mềm tính toán hướng và góc phù hợp.

Căn cứ vào mặt bằng thực tế.

Dựa vào hai yếu tố trên, đề xuất phương án, giải pháp về hướng và góc cụ thể của từng công trình.

## Cáp DC

Hình ảnh	Thông số chi tiết	4 mm <sup>2</sup>	6 mm <sup>2</sup>
	Kết cấu ruột dẫn	80/0.25	120/0.25
	Đường kính ruột dẫn (mm)	2.58	3.16
	Chiều dày cách điện (mm)	0.7	0.7
	Chiều dày vỏ bảo vệ (Ω/km)	0.8	0.8
	Đường kính ngoài gần đúng (Kg/km)	5.6	6.2
	Khối lượng gần đúng (m)	58	79
	Điện trở ruột dẫn tối đa ở 20°C	5.09	3.39
	Điện trở cách điện tối đa ở 20°C	580	500
	Điện trở cách điện tối đa ở 90°C	0.58	0.50
	Dòng điện cho phép	Cáp đơn đặt trong không khí	55
Cáp đơn đặt trên một bề mặt		52	67
Hai cáp đặt cạnh trên một bề mặt		44	57

**CERTIFICATE**  
of Conformity  
EC Council Directive 2004/108/EC  
Electromagnetic Compatibility

  
TÜVRheinland

Registration No.: AE 50335059 0001  
Report No.: 17057601 001

Holder: **MANH PHUONG ELECTRIC CO.,LTD (MPE)**  
L37 Mieu Noi area, Ward 3,  
Binh Thanh dist  
HOCHIMINH 700000  
Vietnam

Product: Indoor Lamp  
(LED Bulb)

Identification: Type Designation: LB-3X LB-5X LB-7X LB-9X LB-12X  
LB-15X LB-20X LB-30X LB-40X  
(X= T or V)  
Serial No. : Engineering samples  
Remark: Refer to above-listed test report for details.

Tested acc. to: EN 55015:2013  
EN 61000-3-2:2014  
EN 61000-3-3:2013  
EN 61547:2009

This certificate of conformity is based on an evaluation of a sample of the above mentioned product. Technical Report and documentation are at the Licence Holder's disposal. This is to certify that the tested sample is in conformity with all provisions of Annex I of Council Directive 2004/108/EC. This certificate does not imply assessment of the production of the product and does not permit the use of a TÜV Rheinland mark of conformity. The holder of the certificate is authorized to use this certificate in connection with the EC declaration of conformity according to the a.m. Directive.

  
Certification Body  
Date 25.03.2016  
Tim Feng

TÜV Rheinland LGA Products GmbH - Tillystraße 2 - 90431 Nürnberg

CE The CE marking may only be used if all relevant and effective EC Directives are complied with. CE

**CERTIFICATE**  
of Conformity  
EC Council Directive 2014/30/EU  
Electromagnetic Compatibility

  
TÜVRheinland

Registration No.: AE 50335725 0001  
Report No.: 17057599 001

Holder: **MANH PHUONG ELECTRIC CO.,LTD (MPE)**  
L37 Mieu Noi area, Ward 3,  
Binh Thanh dist  
HOCHIMINH 700000  
Vietnam

Product: Indoor Lamp  
(LED TUBE)

Identification: Type Designation: LTB-120X LTB-60X  
(X= T or V)  
Serial No. : Engineering samples  
Remark: Refer to above-listed test report for details.  
Valid from 20. April 2016

Tested acc. to: EN 55015:2013  
EN 61000-3-2:2014  
EN 61000-3-3:2013  
EN 61547:2009

This certificate of conformity is based on an evaluation of a sample of the above mentioned product. Technical Report and documentation are at the Licence Holder's disposal. This is to certify that the tested sample is in conformity with all provisions of Annex I of Council Directive 2014/30/EU. This certificate does not imply assessment of the production of the product and does not permit the use of a TÜV Rheinland mark of conformity. The holder of the certificate is authorized to use this certificate in connection with the EC declaration of conformity according to the a.m. Directive.

  
Certification Body  
Date 25.03.2016  
Tim Feng

TÜV Rheinland LGA Products GmbH - Tillystraße 2 - 90431 Nürnberg

CE The CE marking may only be used if all relevant and effective EC Directives are complied with. CE

**CERTIFICATE**  
of Conformity  
EC Council Directive 2014/30/EU  
Electromagnetic Compatibility

  
TÜVRheinland

Registration No.: AE 50335734 0001  
Report No.: 17057603 001

Holder: **MANH PHUONG ELECTRIC CO.,LTD (MPE)**  
L37 Mieu Noi area, Ward 3,  
Binh Thanh dist  
HOCHIMINH 700000  
Vietnam

Product: Indoor Lamp  
(LED Panel Light)

Identification: RPL-6X RPL-9X RPL-12X RPL-15X RPL-18X SPL-6X  
SRPL-6X SSPL-6X SPL-9X SPL-12X SRPL-12X SSPL-12X  
SPL-15X SPL-18X SRPL18X SSPL18X SPL-3030X  
FPL-6030X FPL-6060X FPL-12030X (X=V or T)  
Serial No. : Engineering samples  
Remark: Refer to above-listed test report for details.  
Valid from 20. April 2016

Tested acc. to: EN 55015:2013  
EN 61000-3-2:2014  
EN 61000-3-3:2013  
EN 61547:2009

This certificate of conformity is based on an evaluation of a sample of the above mentioned product. Technical Report and documentation are at the Licence Holder's disposal. This is to certify that the tested sample is in conformity with all provisions of Annex I of Council Directive 2014/30/EU. This certificate does not imply assessment of the production of the product and does not permit the use of a TÜV Rheinland mark of conformity. The holder of the certificate is authorized to use this certificate in connection with the EC declaration of conformity according to the a.m. Directive.

  
Certification Body  
Date 25.03.2016  
Tim Feng

TÜV Rheinland LGA Products GmbH - Tillystraße 2 - 90431 Nürnberg

CE The CE marking may only be used if all relevant and effective EC Directives are complied with. CE

**Sản phẩm đạt tiêu chuẩn Châu Âu**



# NHÀ MÁY THÔNG MINH - ĐẠT TIÊU CHUẨN LEED CỦA MỸ

## NĂNG LƯỢNG MẶT TRỜI

SẢN XUẤT NĂNG LƯỢNG HIỆU QUẢ

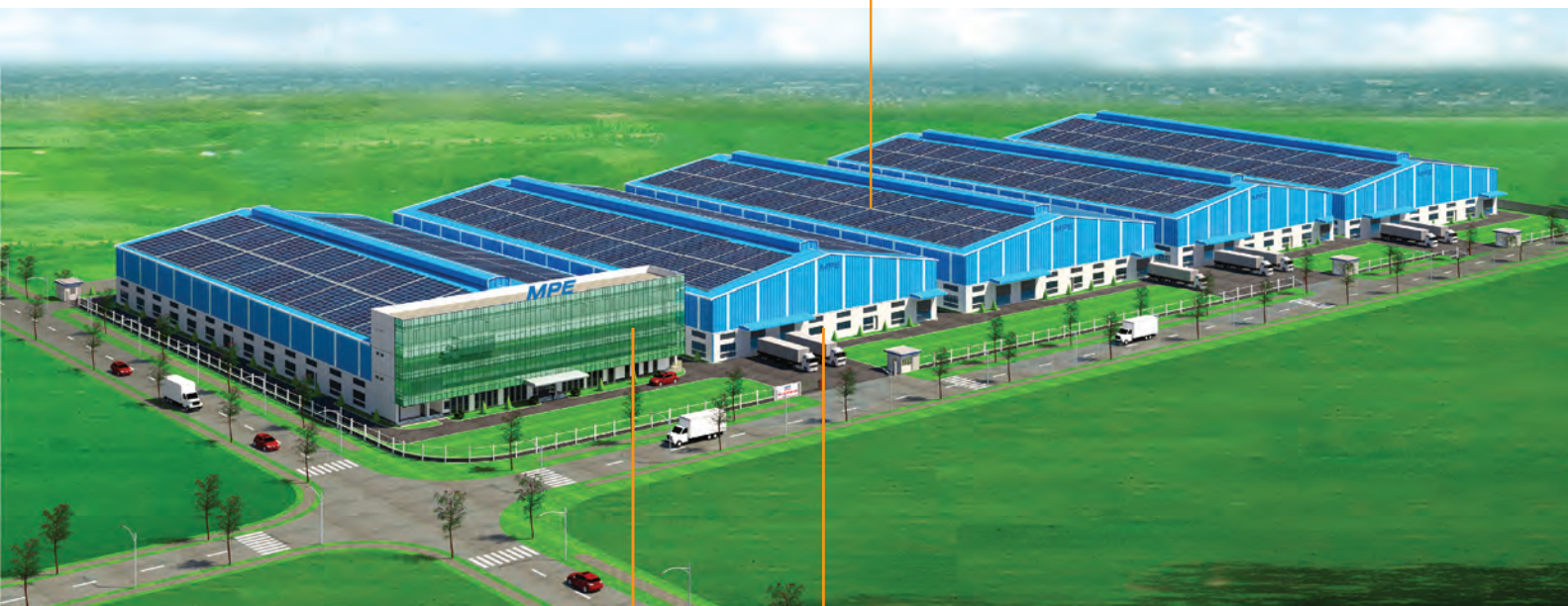

## THIẾT BỊ THÔNG MINH

QUẢN LÝ NĂNG LƯỢNG THÔNG MINH

## ĐÈN LED THIẾT BỊ ĐIỆN

SỬ DỤNG NĂNG LƯỢNG TIẾT KIỆM

TP.HCM : 272A Nguyễn Trãi, P.8, Q.5, Tp.Hồ Chí Minh  
Đà Nẵng : Lô A2-7, Đường Nguyễn Tất Thành Nối Dài, Tp.Đà Nẵng  
Cần Thơ : 37A KV Thạnh Huê, P.Thường Thạnh, Q.Cái Răng, Tp.Cần Thơ  
Hà Nội : 524 Minh Khai, P.Hai Bà Trưng, Hà Nội  
Đắk Lắk : Cụm KCN Tân An, P.Tân An, TP. Buôn Mê Thuật, Đắk Lắk  
TP.HCM : Lô II-6, Đường CN11, KCN Tân Bình, Q.Tân Phú, Tp.HCM  
Nhà Máy 1 : Lô C4 - C11, Đường số 4, KCN Nhị Xuân, H.Hóc Môn, Tp.HCM  
Nhà máy 2 : Lô LG14-15-16, Đường số 3, KCN Xuyên Á, H.Đức Hòa, Long An

